

1 2 3 4 5 6

SK40 SFH05 080 AD+B/2.5G 25000 SL

A A

B B

C C

D

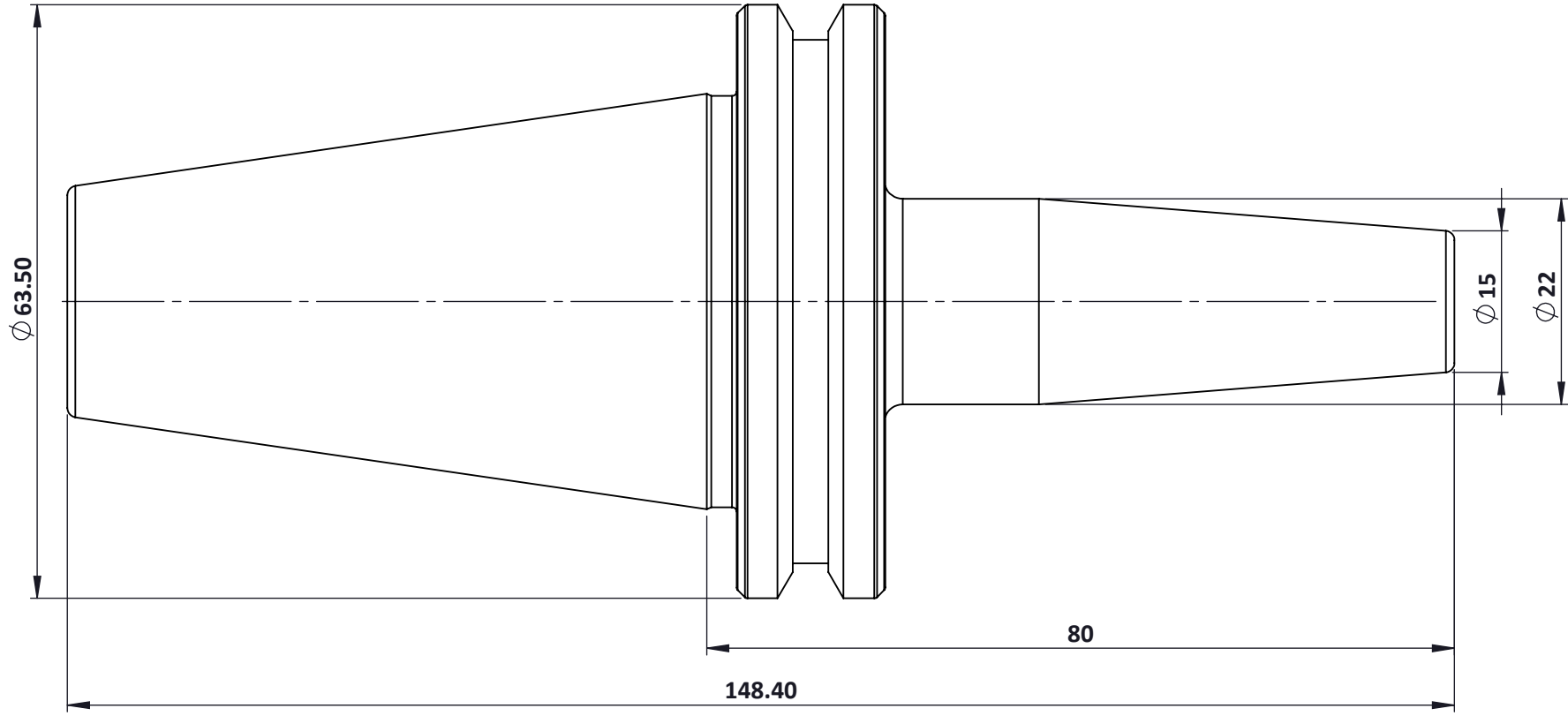

1 2 3 4 5 6