

1

2

3

4

5

6

HSK-A 63 MCA10 025 2.5G 25000 SL

A

A

B

B

C

C

D

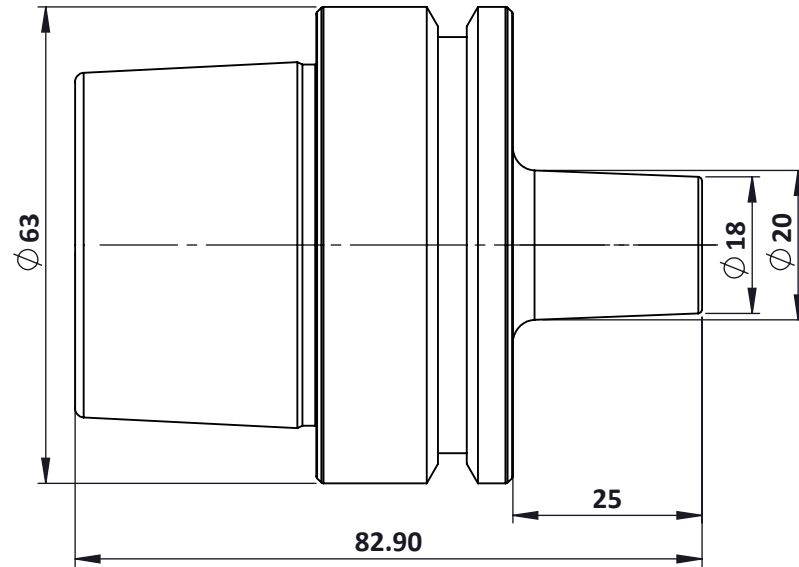

1

2

MATERIAL:

WEIGHT:

SHEET 1 OF 1

A4