

1 2 3 4 5 6

SK 40 ER 40 100 AD+B/6.3G15000 SL

A

A

B

B

C

C

D

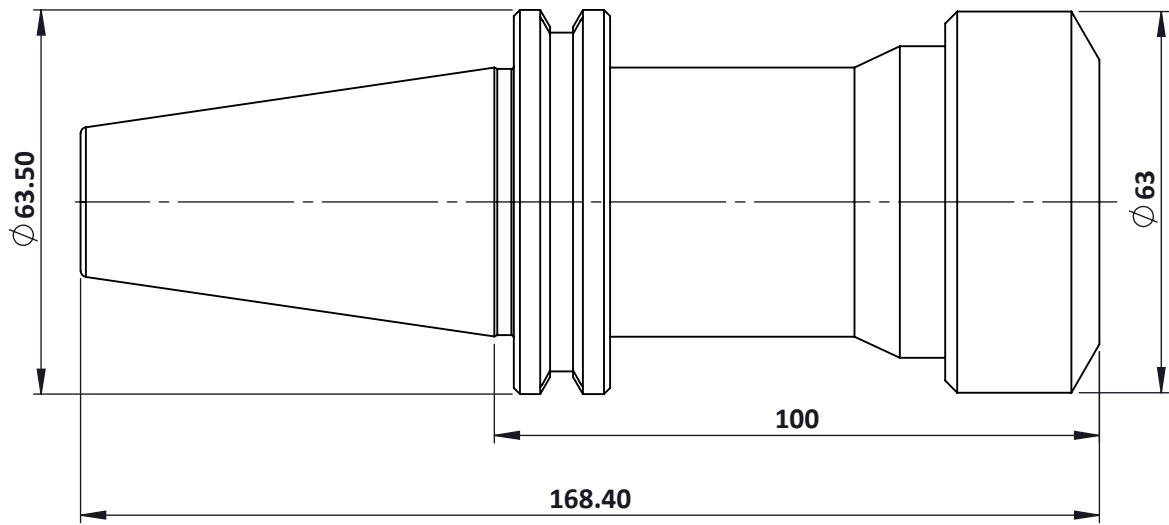
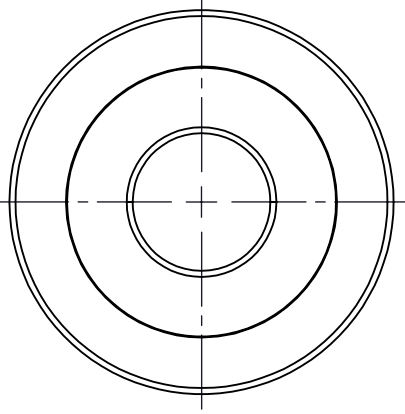

1 2 MATERIAL: WEIGHT: SHEET 1 OF 1