

1

2

3

4

5

6

SK 50 ER 32 100 AD+B/6.3G15000 SL

A

A

B

B

C

C

D

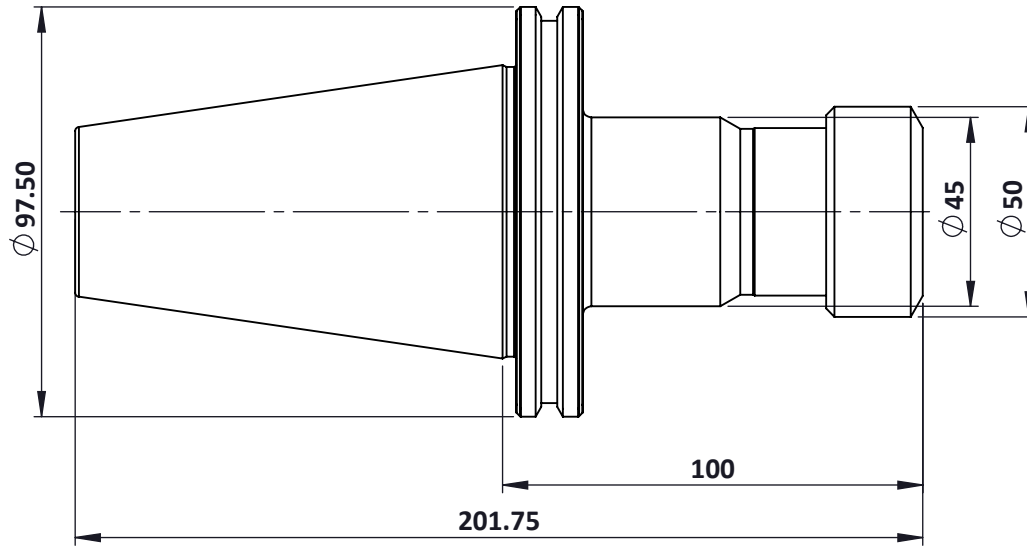
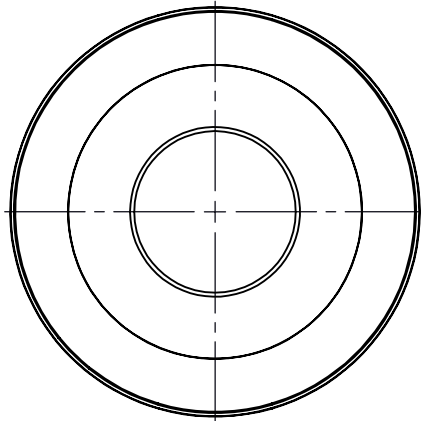

1

2

MATERIAL:

WEIGHT:

SHEET 1 OF 1