



INDEX



Omega EU Stock Centre, opened May 2021

Omega Products stock and supply trade distributors one of the UK's largest ranges of engineering tooling including:

- Indexable Carbide Tooling
- Carbide Shank Boring Bars
- Spindle Tooling & Accessories
- Drilling & Tapping Tools
- Milling Tools
- Workholding & Vices

A little about Omega:

QUALITY TOOLING

We only sell high quality tooling and will not settle for less

COMPETITIVE PRICES

Our pricing is consistently competitive and transparent

CUSTOMER SERVICE

Our customers will always come first. Customer service is not just a department, it is our company

TRUST

Our word is our bond, we will always tell the truth and do as we say

Omega Products

45 Cobham Road
Ferndown Industrial Estate
Wimborne BH21 7QZ

T 01202 745179
E sales@omegaproducts.co.uk
W omegaproducts.co.uk

Prices in this catalogue are guide prices only and may be subject to change. Please check online to verify pricing.

Page	Index
6	DCBNR/L Turning Tools
6	DCKNR/L Turning Tools
7	DCLNR/L Turning Tools
7	DDJNR/L Turning Tools
8	DTGNR/L Turning Tools
8	DVJNR/L Turning Tools
9	DVVNN Turning Tools
9	DWLNR/L Turning Tools
10	ETJNR/L Turning Tools
11	PCBNR/L Turning Tools
11	PCKNR/L Turning Tools
12	PCLNR/L Turning Tools
12	PDJNR/L Turning Tools
13	PSBNR/L Turning Tools
13	PSKNR/L Turning Tools
14	PSSNR/L Turning Tools
14	PWLNLR/L Turning Tools
15	SCACR/L Turning Tools
15	SCLCR/L Turning Tools
16	SDACR/L Turning Tools
16	SDJCR/L Turning Tools
16	SDJCR/LS Turning Tools
17	SDNCN Turning Tools
18	SVJBR/L Turning Tools
18	SVJCR/L Turning Tools

Page	Index
19	SVVBN Turning Tools
19	SVVCN Turning Tools
20	SCLCR/L Mini Carbide Boring Bars
21	S-SCLCR/L Boring Bars
22	A-SCLCR/L Boring Bars
23	C-SCLCR/L Boring Bars
23	E-SCLCR/L Boring Bars
24	S-SDUCR/L Boring Bars
24	A-SDUCR/L Boring Bars
25	C-SDUCR/L Boring Bars
26	E-SDUCR/L Boring Bars
26	S-SDQCR/L Boring Bars
27	S-SDZCR/L Boring Bars
27	S-SVUCR/L Boring Bars
28	A-SVUCR/L Boring Bars
28	S-SVJCR/L Boring Bars
29	S-DCLNR/L Boring Bars
29	A-DCLNR/L Boring Bars
30	S-DDUNR/L Boring Bars
30	S-DTFNR/L Boring Bars
31	S-DVUNR/L Boring Bars
31	S-DWLNR/L Boring Bars
32	A-DWLNR/L Boring Bars
32	S-PCLNR/L Boring Bars

Page	Index
33	S-PWLNLR/L Boring Bars
34-35	Boring Bar Sets
36	SER/L Threading Tools
36	CER/L Threading Tools
37	SIR/L Threading Bars
38	CNR/L Threading Bars
38	C-SIR Carbide Threading Bars
39	Parting Off Blocks, Blades & Inserts
40	APKT End Mills & Inserts
41	WCGX U-Drills & Inserts
43	2xD SPMG U-Drills
44	3xD SPMG U-Drills
45	4xD SPMG u-Drills
46	SPMG & SPGG Drilling Inserts
47	Centre & Chamfer Drills & Inserts
48	Inserts for Aluminium
49	Inserts for Steel
50	Inserts for Stainless Steel
50	Inserts for Heat Resistant Alloys
51	Technical Insert Information
52	External Threading Inserts
53	Internal Threading Inserts
55-58	BT ER Collet Chucks
59	BT OZ Collet Chucks
59	BT DMC Collet Chucks

Page	Index
60	BT GSK Collet Chucks
61	BT Hydraulic Expansion Chucks
62	BT Power Milling Chucks
63	BT Shrink Fit Chucks
64-65	BT Milling Cutter Arbors
66-69	BT End Mill Holders
70-72	BT Face Mill Arbors
73	BT Combi Shell Mill Arbors
74	BT Morse Taper Adaptors
75	BT MLC Synchro Tapping Chucks
75	BT Quick Change Tapping Chucks



INDEX

Page	Index
76	BT Integral Drill Chucks
77	BT Drill Chuck Adaptors
77	BT Test Arbors
77	BT Machinable Blanks
79-81	DIN69871 ER Collet Chucks
82	DIN69871 OZ Collet Chucks
82	DIN69871 DMC Collet Chucks
83	DIN69871 GSK Collet Chucks
84	DIN69871 Hydraulic Expansion Chucks
85	DIN69871 Power Milling Chucks
86	DIN69871 Shrink Fit Chucks
87-88	DIN69871 Milling Cutter Arbors
89-92	DIN69871 End Mill Holders
93-95	DIN69871 Face Mill Arbors
96	DIN69871 Combi Shell Mill Arbors
97	DIN69871 Morse Taper Adaptors
98	DIN69871 MLC Synchro Tapping Chucks
98	DIN69871 Quick Change Tapping Chucks
99	DIN69871 Integral Drill Chucks
100	DIN69871 Drill Chuck Adaptors
100	DIN69871 Test Arbors
100	DIN69871 Machinable Blanks
101	DIN2080 ER Collet Chucks
102	DIN2080 End Mill Holders
103	DIN2080 Face Mill Arbors
104	DIN2080 Morse Taper Adaptors
104	DIN2080 Quick Change Tapping Chucks
105	DIN2080 Integral Drill Chucks
105	DIN2080 Drill Chuck Arbors
105	DIN2080 Machinable Blanks
107	HSK63A ER Collet Chucks
108	HSK63A DMC Collet Chucks
108	HSK63A Hydraulic Expansion Chucks
109	HSK63A Shrink Fit Chucks
110	HSK63A Milling Cutter Arbors
110	HSK63A Power Milling Chucks
111	HSK63A End Mill Holders

Page	Index
112-113	HSK63A Face Mill Holders
113	HSK63A Morse Taper Adaptors
114	HSK63A MLC Synchro Tapping Chucks
114	HSK63A Integral Drill Chucks
115	HSK63A Test Arbors
115	HSK63A Machinable Blanks
117	HSK63F ER Collet Chucks
117	HSK63F Face Mill Arbors
119	VDI Form A1, A2
120	VDI Form B1, B2
121	VDI Form B3, B4
122	VDI Form B5, B6
123	VDI Form B7, B8
124	VDI Form C1, C2
125	VDI Form C3, C4
126	VDI Form D1, D2
127	VDI Form E1
128	VDI Form E2
129	VDI Form E4
130	VDI Form E7, E8
131	VDI Form F1
132	VDI Form AR, AL
133	VDI Form ARU, ALU
134	VDI Hydraulic Chucks
134	VDI Integral Drill Chucks
135	VDI Bar Pullers
136-137	VDI Spares
138-145	VDI Driven Tooling
146	Straight Shank ER Collet Chucks
147	Straight Shank Mini ER Collet Chucks
148	Straight Shank DMC Collet Chucks
149	Straight Shank Shrink Fit Chucks
150	Straight Shank Tapping Chucks
151	Straight Shank Floating Reamer Holders
151	Straight Shank Integral Drill Chucks
152-153	R8 Bridgeport Tooling
154	ER8 / ER11 Collets



Page	Index
155	ER16 Collets
156	ER20 Collets
157	ER25 Collets
158	ER32 Collets
159	ER40 Collets
160	ER50 Collets
161	ER16 / ER20 Standard Sealed Collets
162	ER25 / ER32 Standard Sealed Collets
163	ER40 Standard Sealed Collets
164	ER11 / ER16 High Pressure Sealed Collets
165	ER20 / ER25 High Pressure Sealed Collets
166	ER32 High Pressure Sealed Collets
167	ER40 High Pressure Sealed Collets
168	ER16 / ER20 Jet Coolant Sealed Collets
169	ER25 / ER32 Jet Coolant Sealed Collets
170	ER16 / ER20 Tapping Collets
171	ER25 Tapping Collets
172	ER32 Tapping Collets
173	ER40 Tapping Collets
174-175	ER Imperial Collets
176-179	ER Collet Sets
180	OZ12 / OZ16 Collets
181	OZ25 / OZ32 Collets
182	GSK06 / GSK10 Collets
183	GSK16 / GSK25 Collets

Page	Index
184	DMC Collets
184	Straight Collets
185	Hydraulic Reduction Sleeves
186	Quick Change ER16 Tapping Collets
187	Quick Change ER20 Tapping Collets
188	Quick Change ER25 Tapping Collets
189	Quick Change ER32 Tapping Collets
190-191	Quick Change ER40 Tapping Collets
192	Quick Change Tap Adaptors With Clutch
193	Quick Change Tap Adaptors Without Clutch
194-195	Technical Tapping Information
196	Boring Heads & Adaptors
197-198	Boring Bar Sets for Boring Heads
199-201	Boring Bar Reduction Sleeves
202	Morse Taper ER Collet Chucks
202	Turret Sockets
203	MT Reduction & Extension Sleeves
204	MT Integral Drill Chucks
204	Drill Chucks
205	Tightening Fixtures
206-213	Pull Studs
214-218	Spares
219	Modular Vices & Vice Jaws
220-221	Revolving Centres
222-223	Dead Centres

DCBNR/L 75° CNMG

- External Turning Tools

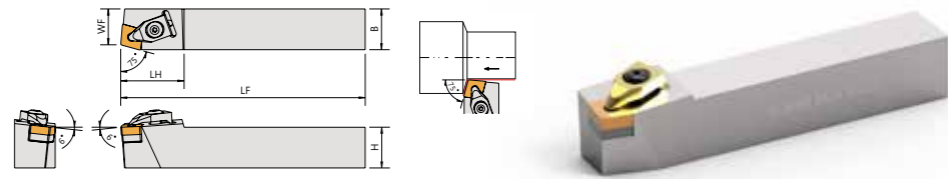

Part Number		Toolholder ISO	Insert	Dimensions (mm)					Price
R/H	L/H			H	B	LF	LH	WF	£
OM11230	OM11231	DCBNR/L 2020 K12	CNMG 1204	20	20	125	37	17	£36.00
OM11232	OM11233	DCBNR/L 2525 M12		25	25	150	37	22	£39.00
OM11234	OM11235	DCBNR/L 3225 P12		32	25	170	37	22	£52.00

Spare Parts

Designation	Insert Shim	£	Shim Screw	£	Insert Clamp	£	Clamp Spring	£	Clamp Screw	£	Torx Key	£
...12	OM14074 (SMC-432)	£5.90	OM14054 (CSF-4010)	£2.20	OM14008 (CP-D4)	£8.60	OM14099 (SP-0816)	£4.80	OM14046 (CSB-0620T)	£2.20	OM14103 (TL-20)	£6.00

DCKNR/L 75° CNMG

- External Turning Tools

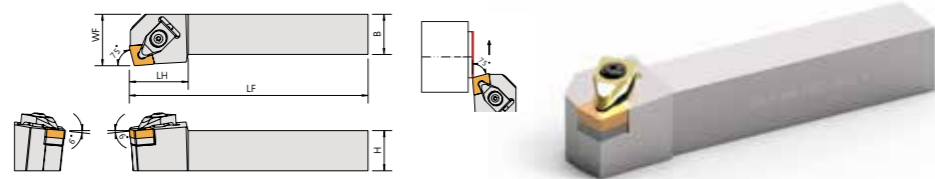

Part Number		Toolholder ISO	Insert	Dimensions (mm)					Price
R/H	L/H			H	B	LF	LH	WF	£
OM11236	OM11237	DCKNR/L 2020 K12	CNMG 1204	20	20	125	37	25	£36.00
OM11238	OM11239	DCKNR/L 2525 M12		25	25	150	37	32	£39.00
OM11240	OM11241	DCKNR/L 3225 P12		32	25	170	37	32	£52.00

Spare Parts

Designation	Insert Shim	£	Shim Screw	£	Insert Clamp	£	Clamp Spring	£	Clamp Screw	£	Torx Key	£
...12	OM14074 (SMC-432)	£5.90	OM14054 (CSF-4010)	£2.20	OM14008 (CP-D4)	£8.60	OM14099 (SP-0816)	£4.80	OM14046 (CSB-0620T)	£2.20	OM14103 (TL-20)	£6.00

DCLNR/L 95° CNMG

- External Turning Tools

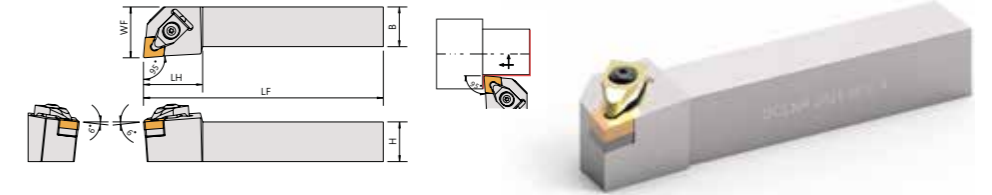

Part Number		Toolholder ISO	Insert	Dimensions (mm)					Price
R/H	L/H			H	B	LF	LH	WF	£
OM12001	OM12002	DCLNR/L 2020 K12	CNMG 1204	20	20	125	40	25	£34.00
OM12003	OM12004	DCLNR/L 2525 M12		25	25	150	36	32	£37.00
OM12005	OM12006	DCLNR/L 3225 P12		32	25	170	36	32	£49.00
OM1242	OM1243	DCLNR/L 3232 P12		32	32	170	36	32	£52.00

Spare Parts

Designation	Insert Shim	£	Shim Screw	£	Insert Clamp	£	Clamp Spring	£	Clamp Screw	£	Torx Key	£
...12	OM14074 (SMC-432)	£5.90	OM14054 (CSF-4010)	£2.20	OM14008 (CP-D4)	£8.60	OM14099 (SP-0816)	£4.80	OM14046 (CSB-0620T)	£2.20	OM14103 (TL-20)	£6.00

DDJNR/L 93° DNMG

- External Turning Tools

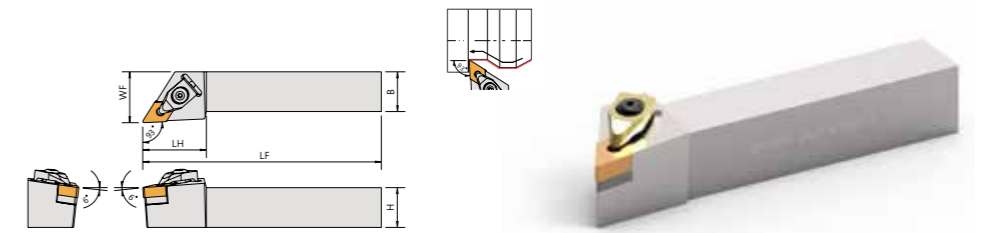

Part Number		Toolholder ISO	Insert	Dimensions (mm)					Price
R/H	L/H			H	B	LF	LH	WF	£
OM12023	OM12024	DDJNR/L 1616 H11	DNMG 1104	16	16	100	36	20	£38.00
OM12025	OM12026	DDJNR/L 2020 K11		20	20	125	36	25	£40.00
OM12027	OM12028	DDJNR/L 2525 M11		25	25	150	36	32	£43.00
OM12029	OM12030	DDJNR/L 2020 K15-06	DNMG 1506	20	20	125	43	25	£40.00
OM12031	OM12032	DDJNR/L 2525 M15-06		25	25	150	43	32	£43.00
OM1244	OM1245	DDJNR/L 3232 M15-06		32	32	170	43	40	£62.00

Spare Parts

- To use DNMG 1504 size insert in DNMG 1506 holders, use shim OM14083 (SMD-463)
- Tool supplied with OM14082 (SMD-443) for DNMG 1506

Designation	Insert Shim	£	Shim Screw	£	Insert Clamp	£	Clamp Spring	£	Clamp Screw	£	Torx Key	£
...1104	OM14080 (SMD-343)	£5.90	OM14039 (CSA-40075)	£2.20	OM14006 (CP-D2)	£8.60	OM14097 (SP-0612)	£4.80	OM14044 (CSB-04150)	£2.20	OM14102 (TL-15)	£6.00
...1506	OM14082 (SMD-443)	£5.90	OM14054 (CSF-4010)	£2.20	OM14008 (CP-D4)	£8.60	OM14099 (SP-0816)	£4.80	OM14046 (CSB-0620T)	£2.20	OM14103 (TL-20)	£6.00
..1504	OM14083 (SMD-463)	£5.90	OM14054 (CSF-4010)	£2.20	OM14008 (CP-D4)	£8.60	OM14099 (SP-0816)	£4.80	OM14046 (CSB-0620T)	£2.20	OM14103 (TL-20)	£6.00

DTGNR/L 91° TNMG

- External Turning Tools

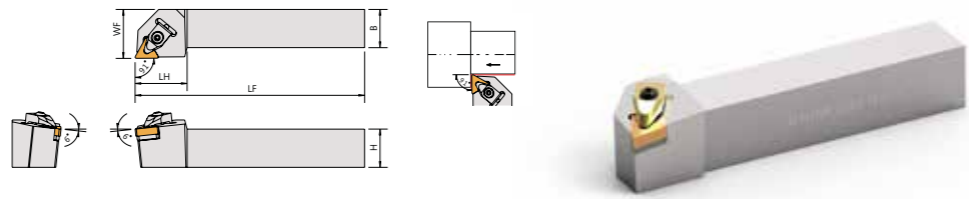

Part Number		Toolholder ISO	Insert	Dimensions (mm)					Price
R/H	L/H			H	B	LF	LH	WF	£
OM11246	OM11247	DTGNR/L 2020 K16	TNMG 1604	20	20	125	33	25	£38.00
OM11248	OM11249	DTGNR/L 2525 M16		25	25	150	33	32	£41.00

Spare Parts

Designation	Insert Shim	£	Shim Screw	£	Insert Clamp	£	Clamp Spring	£	Clamp Screw	£	Torx Key	£
...16	OM11224 (SMT-323)	£5.90	OM14039 (CSA-40075)	£2.20	OM14006 (CP-D2)	£8.60	OM14097 (SP-0612)	£4.80	OM14044 (CSB-04150)	£2.20	OM14102 (TL-15)	£6.00

DVJNR/L 93° VNMG

- External Turning Tools

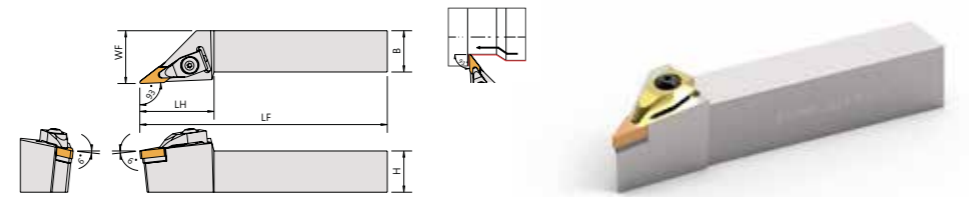

Part Number		Toolholder ISO	Insert	Dimensions (mm)					Price
R/H	L/H			H	B	LF	LH	WF	£
OM12055	OM12056	DVJNR/L 2020 K16	VNMG 1604	20	20	125	50	25	£40.00
OM12057	OM12058	DVJNR/L 2525 M16		25	25	150	46	32	£43.00

Spare Parts

Designation	Insert Shim	£	Shim Screw	£	Insert Clamp	£	Clamp Spring	£	Clamp Screw	£	Torx Key	£
...16	OM14087 (SMV-322)	£5.90	OM14039 (CSA-40075)	£2.20	OM14007 (CP-D3)	£8.60	OM14099 (SP-0816)	£4.80	OM14046 (CSB-0620T)	£2.20	OM14103 (TL-20)	£6.00

DVVNN 72.5° VNMG

- External Turning Tools

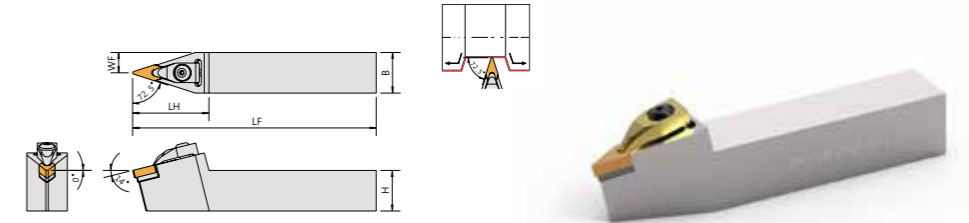

Part Number		Toolholder ISO	Insert	Dimensions (mm)					Price
Neutral				H	B	LF	LH	WF	£
OM12188		DVVNN 2020 K16	VNMG 1604	20	20	125	47	10	£42.00
OM11250		DVVNN 2525 M16		25	25	150	47	12.5	£45.00

Spare Parts

Designation	Insert Shim	£	Shim Screw	£	Insert Clamp	£	Clamp Spring	£	Clamp Screw	£	Torx Key	£
...16	OM14087 (SMV-322)	£5.90	OM14039 (CSA-40075)	£2.20	OM14007 (CP-D3)	£8.60	OM14099 (SP-0816)	£0.80	OM14046 (CSB-0620T)	£2.20	OM14103 (TL-20)	£6.00

DWLNR/L 95° WNMG

- External Turning Tools

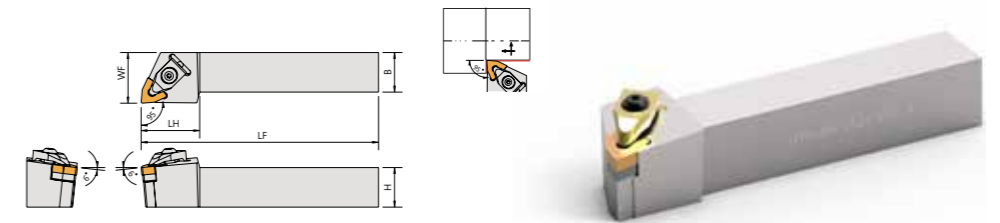

Part Number		Toolholder ISO	Insert	Dimensions (mm)					Price
R/H	L/H			H	B	LF	LH	WF	£
OM12059	OM12060	DWLNR/L 1616 H06	WNMG 0604	16	16	100	33	20	£34.00
OM12061	OM12062	DWLNR/L 2020 K06		20	20	125	33	25	£34.00
OM12063	OM12064	DWLNR/L 2525 M06		25	25	150	33	32	£38.00
OM12065	OM12066	DWLNR/L 2020 K08	WNMG 0804	20	20	125	40	25	£34.00
OM12067	OM12068	DWLNR/L 2525 P08		25	25	150	40	32	£38.00
OM12069	OM12070	DWLNR/L 3225 P08		32	25	170	40	32	£50.00
OM11251	OM11252	DWLNR/L 3232 P08		32	32	170	40	32	£54.00

Spare Parts

Designation	Insert Shim	£	Shim Screw	£	Insert Clamp	£	Clamp Spring	£	Clamp Screw	£	Torx Key	£
...06	OM14088 (SMW-321)	£5.90	OM14039 (CSA-40075)	£2.20	OM14006 (CP-D2)	£8.60	OM14097 (SP-0612)	£4.80	OM14044 (CSB-04150)	£2.20	OM14102 (TL-15)	£6.00
...08	OM14092 (SMW-433)	£5.90	OM14054 (CSF-4010)	£2.20	OM14008 (CP-D4)	£8.60	OM14099 (SP-0816)	£4.80	OM14046 (CSB-0620T)	£2.20	OM14103 (TL-20)	6.00

ETJNR/L 93° TNMG

- External Turning Tools

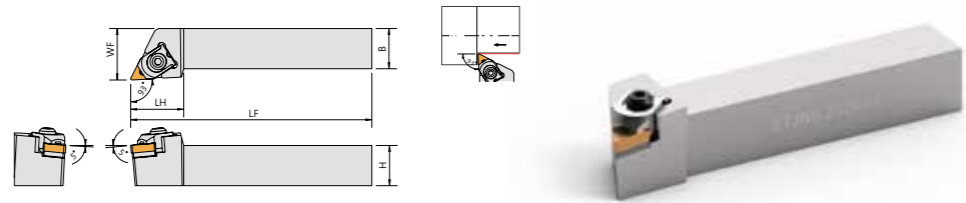

Part Number		Toolholder ISO	Insert	Dimensions (mm)					Price
R/H	L/H			H	B	LF	LH	WF	£
OM11253	OM11254	ETJNR/L 2020 K16	TNMG 1604	20	20	125	32	25	£38.00
OM11255	OM11256	ETJNR/L 2525 M16		25	25	150	32	32	£41.00

Spare Parts

Designation	Insert Shim	£	Shim Screw	£	Insert Clamp	£	Clamp Screw	£	Clip	£	Hex Key	£	Hex Key	£
...16	OM11225 (SMF-322)	£5.90	OM11226 (LCS-513)	£5.00	OM11227 (CPE-T16)	£7.00	OM11228 (CSE8026)	£4.70	OM11229 (ER31)	£2.00	OM14066 (LW-025)	£2.00	OM14172 (LW-050)	£2.00

PCBNR/L 75° CNMG

- External Turning Tools

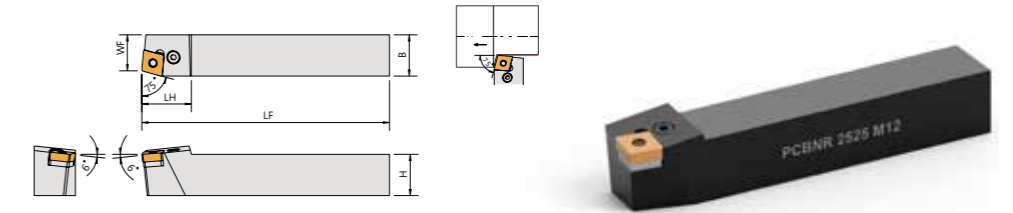

Part Number		Toolholder ISO	Insert	Dimensions (mm)					Price
R/H	L/H			H	B	LF	LH	WF	£
OM12015	OM12016	PCBNR/L 2525 M12	CNMG 1204	25	25	150	30	22	£37.00
OM12017	OM12018	PCBNR/L 3232 P12		32	32	170	30	29	£49.00

Spare Parts

Designation	Insert Shim	£	Shim Clip	£	Insert Lever	£	Lever Screw	£	Hex Key	£
...12	OM14073 (SMC-422)	£5.90	OM14023 (CS-LSP4)	£1.60	OM14012 (CP-LL4)	£5.70	OM14018 (CS-LS4)	£3.90	OM14067 (LW-030)	£2.00

PCKNR/L 75° CNMG

- External Turning

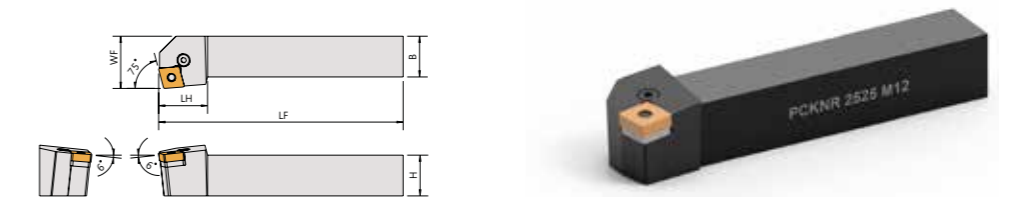

Part Number		Toolholder ISO	Insert	Dimensions (mm)					Price
R/H	L/H			H	B	LF	LH	WF	£
OM12019	OM12020	PCKNR/L 2525 M12	CNMG 1204	25	25	150	26	32	£37.00
OM12021	OM12022	PCKNR/L 3232 P12		32	32	170	40	40	£49.00

Spare Parts

Designation	Insert Shim	£	Shim Clip	£	Insert Lever	£	Lever Screw	£	Hex Key	£
...12	OM14073 (SMC-422)	£5.90	OM14023 (CS-LSP4)	£1.60	OM14012 (CP-LL4)	£5.70	OM14018 (CS-LS4)	£3.90	OM14067 (LW-030)	£2.00

PCLNR/L 95° CNMG

- External Turning Tools

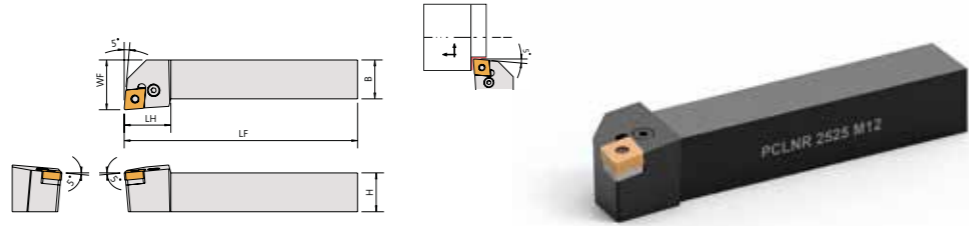

Part Number		Toolholder ISO	Insert	Dimensions (mm)					Price
R/H	L/H			H	B	LF	LH	WF	£
OM12007	OM12008	PCLNR/L 1616 H12	CNMG 1204	16	16	100	20	20	£33.00
OM12009	OM12010	PCLNR/L 2020 K12		20	20	125	26	25	£34.00
OM12011	OM12012	PCLNR/L 2525 M12		25	25	150	26	32	£37.00
OM12013	OM12014	PCLNR/L 3232 P12		32	32	170	33	40	£49.00
OM12180	OM12179	PCLNR/L 3232 P16	CNMG 1604	32	32	170	33	40	£49.00

Spare Parts

Designation	Insert Shim	£	Shim Clip	£	Insert Lever	£	Lever Screw	£	Hex Key	£
...12	OM14073 (SMC-422)	£5.90	OM14023 (CS-LSP4)	£1.60	OM14012 (CP-LL4)	£5.70	OM14018 (CS-LS4)	£3.90	OM14067 (LW-030)	£2.00
...16	OM14116 (SMC-532)	£5.90	OM14025 (CS-LSP7)	£1.60	OM14015 (CP-LL7)	£5.70	OM14020 (CS-LS7)	£3.90	OM14067 (LW-030)	£2.00

PDJNR/L 93° DNMG

- External Turning Tools

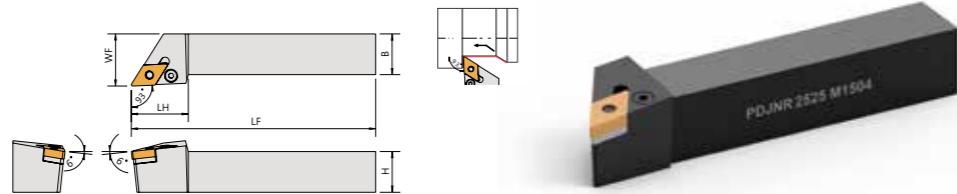

Part Number		Toolholder ISO	Insert	Dimensions (mm)					Price
R/H	L/H			H	B	LF	LH	WF	£
OM12033	OM12034	PDJNR/L 1616 H11	DNMG 1104	16	16	100	20	20	£33.00
OM12035	OM12036	PDJNR/L 2020 K11		20	20	125	35	25	£34.00
OM12037	OM12038	PDJNR/L 2525 M11		25	25	150	35	32	£37.00
OM12039	OM12040	PDJNR/L 2020 K15-06	DNMG 1506	20	20	150	36	25	£34.00
OM12041	OM12042	PDJNR/L 2525 M15-06		25	25	150	36	32	£37.00

Spare Parts

Designation	Insert Shim	£	Shim Clip	£	Insert Lever	£	Lever Screw	£	Hex Key	£
...1104	OM14078 (SMD-331)	£5.90	OM14022 (CS-LSP3)	£1.60	OM14014 (CP-LL6)	£5.70	OM14017 (CS-LS3)	£3.90	OM14066 (LW-025)	£2.00
...1506	OM14081 (SMD-424)	£5.90	OM14023 (CS-LSP4)	£1.60	OM14012 (CP-LL4)	£5.70	OM14018 (CS-LS4)	£3.90	OM14067 (LW-030)	£2.00

PSBNR/L 75° SNMG

- External Turning Tools

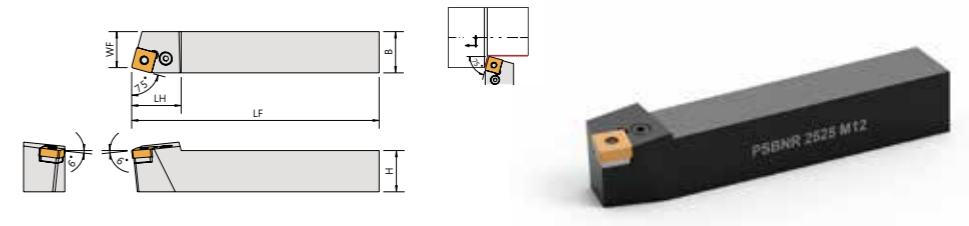

Part Number		Toolholder ISO	Insert	Dimensions (mm)					Price
R/H	L/H			H	B	LF	LH	WF	£
OM12043	OM12044	PSBNR/L 2525 M12	SNMG 1204	25	25	150	30	22	£37.00
OM12045	OM12046	PSBNR/L 3232 P12		32	32	170	35	29	£49.00

Spare Parts

Designation	Insert Shim	£	Shim Clip	£	Insert Lever	£	Lever Screw	£	Hex Key	£
...12	OM14084 (SMS-422)	£5.90	OM14023 (CS-LSP4)	£1.60	OM14012 (CP-LL4)	£5.70	OM14018 (CS-LS4)	£3.90	OM14067 (LW-030)	£2.00

PSKNR/L 75° SNMG

- External Turning Tools

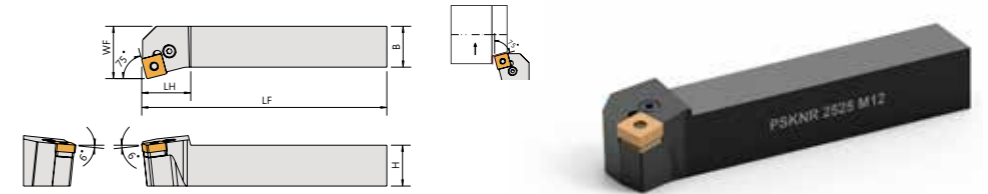

Part Number		Toolholder ISO	Insert	Dimensions (mm)					Price
R/H	L/H			H	B	LF	LH	WF	£
OM12047	OM12048	PSKNR/L 2525 M12	SNMG 1204	25	25	150	30	32	£37.00
OM12049	OM12050	PSKNR/L 3232 P12		32	32	170	30	40	£49.00

Spare Parts

Designation	Insert Shim	£	Shim Clip	£	Insert Lever	£	Lever Screw	£	Hex Key	£
...12	OM14084 (SMS-422)	£5.90	OM14023 (CS-LSP4)	£1.60	OM14012 (CP-LL4)	£5.70	OM14018 (CS-LS4)	£3.90	OM14067 (LW-030)	£2.00

PSSNR/L 45° SNMG

- External Turning Tools

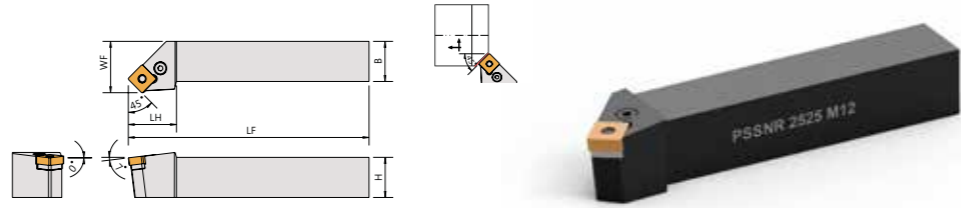

Part Number		Toolholder ISO	Insert	Dimensions (mm)					Price
R/H	L/H			H	B	LF	LH	WF	£
OM11257	OM11258	PSSNR/L 2020 K12	SNMG 1204	20	20	125	30	25	£34.00
OM12051	OM12052	PSSNR/L 2525 M12		25	25	150	30	32	£37.00
OM12053	OM12054	PSSNR/L 3232 P12		32	32	170	36	40	£49.00

Spare Parts

Designation	Insert Shim	£	Shim Clip	£	Insert Lever	£	Lever Screw	£	Hex Key	£
...12	OM14084 (SMS-422)	£5.90	OM14023 (CS-ISP4)	£1.60	OM14012 (CP-LL4)	£5.70	OM14018 (CS-LS4)	£3.90	OM14067 (LW-030)	£2.00

PWLNR/L 95° WNMG

- External Turning Tools

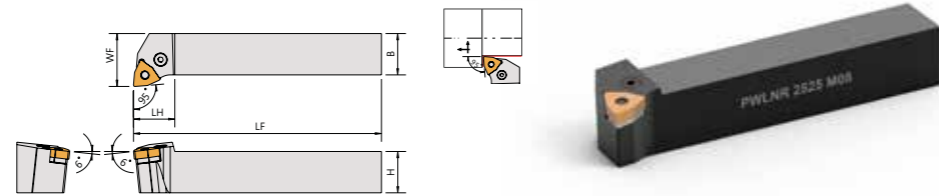

Part Number		Toolholder ISO	Insert	Dimensions (mm)					Price
R/H	L/H			H	B	LF	LH	WF	£
OM12071	OM12072	PWLNR/L 1616 H06	WNMG 0604	16	16	100	20	20	£33.00
OM12073	OM12074	PWLNR/L 2020 K06		20	20	125	20	25	£34.00
OM12075	OM12076	PWLNR/L 2525 M06		25	25	150	23	32	£37.00
OM12077	OM12078	PWLNR/L 2020 K08	WNMG 0804	20	20	125	20	25	£34.00
OM12079	OM12080	PWLNR/L 2525 M08		25	25	150	26	32	£37.00
OM12081	OM12082	PWLNR/L 3232 M08		32	32	170	30	40	£49.00

Spare Parts

Designation	Insert Shim	£	Shim Clip	£	Insert Lever	£	Lever Screw	£	Hex Key	£
...06	OM14089 (SMW-322)	£5.90	OM14022 (CS-ISP3)	£1.60	OM14011 (CP-LL3)	£5.70	OM14017 (CS-LS3)	£3.90	OM14066 (LW-025)	£2.00
...08	OM14090 (SMW-423)	£5.90	OM14023 (CS-ISP4)	£1.60	OM14012 (CP-LL4)	£5.70	OM14018 (CS-LS4)	£3.90	OM14067 (LW-030)	£2.00

SCACR/L 90° CCMT

- External Turning Tools



Part Number		Toolholder ISO	Insert	Dimensions (mm)				Price
R/H	L/H			A	B	LF	WF	£
OM11259	OM11260	SCACR/L 0808 K06	CCMT 0602	8	8	100	8	£27.00
OM12083	OM12084	SCACR/L 1010 H06		10	10	100	10	£27.00
OM12085	OM12086	SCACR/L 1212 H06		12	12	100	12	£27.00
OM12087	OM12088	SCACR/L 1616 H06		16	16	100	16	£30.00

Spare Parts

Designation	Insert Screw	£	Hex Key	£
...06	OM14030 (CS-25060)	£2.20	OM14056 (FT-7)	£5.50

SCLCR/L 95° CCMT

- External Turning Tools

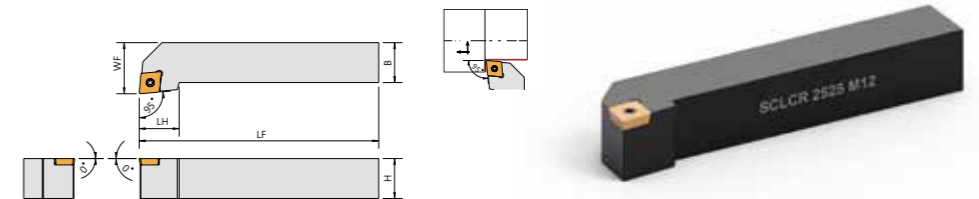

Part Number		Toolholder ISO	Insert	Dimensions (mm)					Price
R/H	L/H			H	B	LF	LH	WF	£
OM12089	OM12090	SCLCR/L 0808 H06	CCMT 0602	8	8	100	12	10	£26.00
OM12091	OM12092	SCLCR/L 1010 H06		10	10	100	12	12	£26.00
OM12093	OM12203	SCLCR/L 1212 H06		12	12	100	17	16	£27.00
OM12094	OM12095	SCLCR/L 1212 H09	CCMT 09T3	12	12	100	17	16	£27.00
OM12096	OM12097	SCLCR/L 1616 H09		16	16	100	18	20	£30.00
OM12098	OM12099	SCLCR/L 2020 K09		20	20	125	22	25	£31.00
OM12100	OM12101	SCLCR/L 2525 M09		25	25	150	26	32	£35.00
OM12102	OM12103	SCLCR/L 2020 K12	CCMT 1204	20	20	125	22	25	£31.00
OM12104	OM12105	SCLCR/L 2525 M12		25	25	150	26	32	£35.00

Spare Parts

Designation	Insert Screw	£	Hex Key	£
...06	OM14030 (CS-25060)	£2.20	OM14056 (FT-7)	£5.50
...09	OM14035 (CS-35090)	£2.20	OM14059 (FT-15)	£5.50
...12	OM14042 (CS-40115)	£2.20	OM14059 (FT-15)	£5.50

SDACR/L 90° DCMT

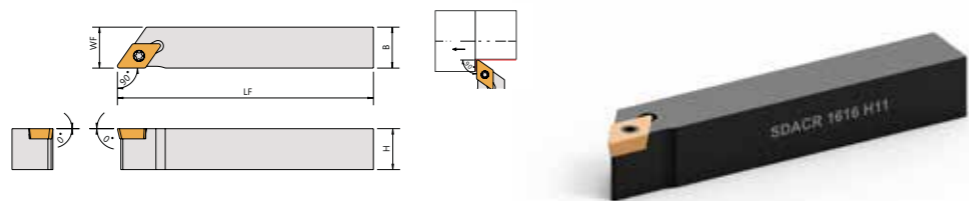

- External Turning Tools

Part Number		Toolholder ISO	Insert	Dimensions (mm)				Price
R/H	L/H			H	B	LF	WF	£
OM11261	OM11262	SDACR/L 0808 K07	DCMT 0702	8	8	100	8	£27.00
OM12108	OM12109	SDACR/L 1010 K07		10	10	100	10	£27.00
OM11263	OM11264	SDACR/L 1212 K07		12	12	100	12	£27.00
OM12110	OM12111	SDACR/L 1212 K11	DCMT 11T3	12	12	100	12	£27.00
OM12112	OM12113	SDACR/L 1616 K11		16	16	100	16	£30.00

Spare Parts

Designation	Insert Screw	£	Hex Key	£
...07	OM14030 (CS-25060)	£2.20	OM14056 (FT-7)	£5.50
...11	OM14035 (CS-35090)	£2.20	OM14059 (FT-15)	£5.50

SDJCR/L 93° DCMT

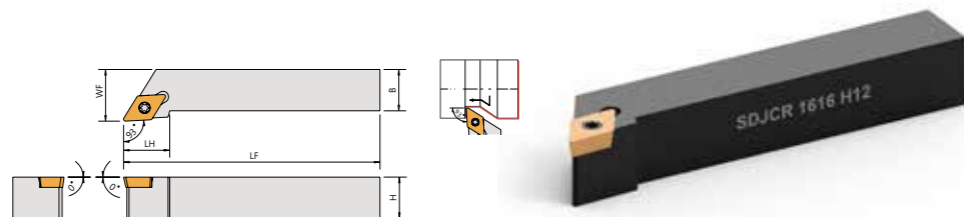

- External Turning Tools
- Without Shim

Part Number		Toolholder ISO	Insert	Dimensions (mm)				Price	
R/H	L/H			H	B	LF	LH	WF	£
OM12116	OM12117	SDJCR/L 0808 H07	DCMT 0702	8	8	100	12.5	10	£26.00
OM12118	OM12119	SDJCR/L 1010 H07		10	10	100	15	12	£26.00
OM12120	OM12121	SDJCR/L 1212 H07		12	12	100	16	16	£27.00
OM12122	OM12123	SDJCR/L 1616 H07		16	16	100	18	20	£30.00
OM12124	OM12125	SDJCR/L 1212 H11	DCMT 11T3	12	12	100	16	16	£27.00
OM12126	OM12127	SDJCR/L 1616 H11		16	16	100	18	20	£30.00
OM12128	OM12129	SDJCR/L 2020 K11		20	20	125	23	25	£31.00
OM12130	OM12131	SDJCR/L 2525 M11		25	25	150	27	32	£35.00

Spare Parts

Designation	Insert Screw	£	Hex Key	£
...07	OM14030 (CS-25060)	£2.20	OM14056 (FT-7)	£5.50
...11	OM14035 (CS-35090)	£2.20	OM14059 (FT-15)	£5.50

SDJCR/L S 93° DCMT

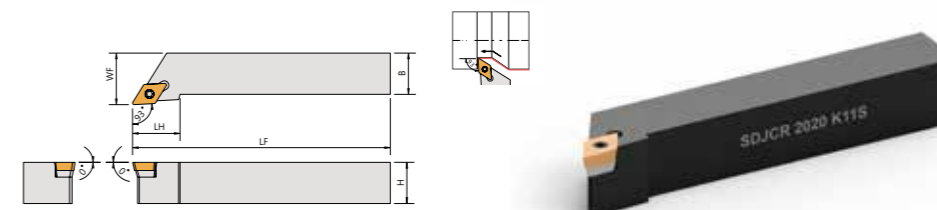

- External Turning Tools
- With Shim

Part Number		Toolholder ISO	Insert	Dimensions (mm)				Price	
R/H	L/H			H	B	LF	LH	WF	£
OM11265	OM11266	SDJCR/L 2020 K11-S	DCMT 11T3	20	20	125	22	25	£35.00
OM11267	OM11268	SDJCR/L 2525 M11-S		25	25	150	25	32	£39.00

Spare Parts

Designation	Insert Shim	£	Shim Screw	£	Insert Screw	£	Torx Key	£	Hex Key	£
...11	OM14080 (SMD-343)	£5.90	OM14093 (SN-535)	£2.80	OM14038 (CS-35115)	£2.20	OM14059 (FT-15)	£5.50	OM14068 (LW-035)	£2.00

SDNCN 62.5° DCMT

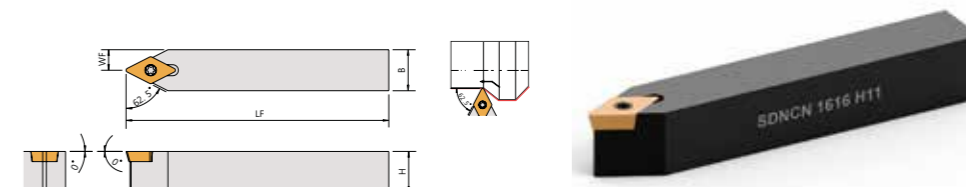

- External Turning Tools

Part Number		Toolholder ISO	Insert	Dimensions (mm)				Price
Neutral				H	B	LF	WF	£
OM12132	SDNCN 1010 H07	DCMT 0702	10	10	100	5	£27.00	
OM12133	SDNCN 1212 F07		12	12	100	6	£27.00	
OM12214	SDNCN 1212 H11		12	12	100	6	£27.00	
OM12134	SDNCN 1616 H11	DCMT 11T3	16	16	100	8	£30.00	
OM11269	SDNCN 2020 K11		20	20	125	10	£31.00	
OM11270	SDNCN 2525 M11		25	25	150	12.5	£35.00	

Spare Parts

Designation	Insert Screw	£	Hex Key	£
...07	OM14030 (CS-25060)	£2.20	OM14056 (FT-7)	£5.50
...11	OM14035 (CS-35090)	£2.20	OM14059 (FT-15)	£5.50

SVJBR/L 93° VBMT

- External Turning Tools

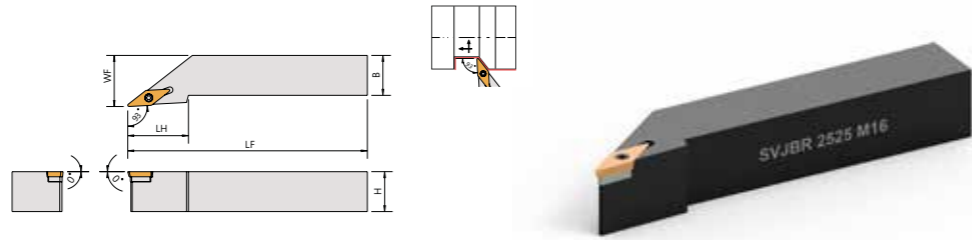

Part Number		Toolholder ISO	Insert	Dimensions (mm)					Price
R/H	L/H			H	B	LF	LH	WF	£
OM12142	OM12143	SVJBR/L 1212 H11N	VBMT 1103	12	12	100	-	12	£31.00
OM12144	OM12145	SVJBR/L 1616 H11N		16	16	100	-	16	£33.00
OM12146	OM12147	SVJBR/L 2020 K11		20	20	125	22	25	£36.00
OM12148	OM12149	SVJBR/L 2020 K16	VBMT 1604	20	20	125	33	25	£39.00
OM12150	OM12151	SVJBR/L 2525 M16		25	25	150	38	32	£41.00
OM12152	OM12153	SVJBR/L 3232 P16		32	32	170	38	42	£62.00

Spare Parts

Designation	Insert Shim	£	Shim Screw	£	Insert Screw	£	Torx Key	£	Hex Key	£
...11	-	-	-	-	OM14030 (CS-25060)	£2.20	OM14056 (FT-7)	£5.50	-	-
...16	OM14086 (SMV-321)	£5.90	OM14093 (SN-535)	£2.80	OM14038 (CS-35115)	£2.20	OM14059 (FT-15)	£5.50	OM14068 (LW-035)	£2.00

SVJCR/L 93° VCMT

- External Turning Tools

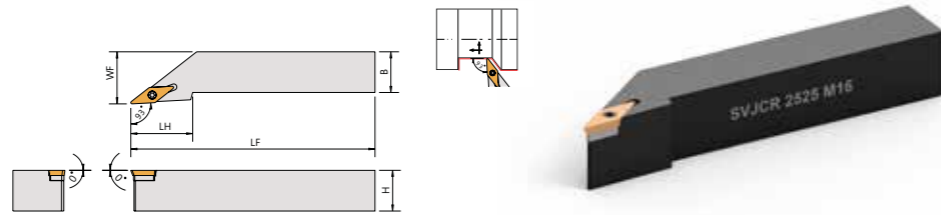

Part Number		Toolholder ISO	Insert	Dimensions (mm)					Price
R/H	L/H			H	B	LF	LH	WF	£
OM12156	OM12157	SVJCR/L 1212 H11N	VCMT 1103	12	12	125	-	12	£31.00
OM12158	OM12159	SVJCR/L 1616 H11N		16	16	125	-	16	£33.00
OM12160	OM12161	SVJCR/L 2020 K11		20	20	125	33	26	£36.00
OM12162	OM12163	SVJCR/L 2525 M11	VCMT 1604	25	25	150	38	32	£41.00
OM12164	OM12165	SVJCR/L 2020 K16		20	20	125	33	25	£39.00
OM12166	OM12167	SVJCR/L 2525 M16		25	25	150	38	32	£41.00
OM12186	OM12187	SVJCR/L 3232 P16		32	32	170	38	42	£62.00

Spare Parts

Designation	Insert Shim	£	Shim Screw	£	Insert Screw	£	Torx Key	£	Hex Key	£
...11	-	-	-	-	OM14030 (CS-25060)	£2.20	OM14056 (FT-7)	£5.50	-	-
...16	OM14086 (SMV-321)	£5.90	OM14093 (SN-535)	£2.80	OM14038 (CS-35115)	£2.20	OM14059 (FT-15)	£5.50	OM14068 (LW-035)	£2.00

SVVBN 72.5° VBMT

- External Turning Tools

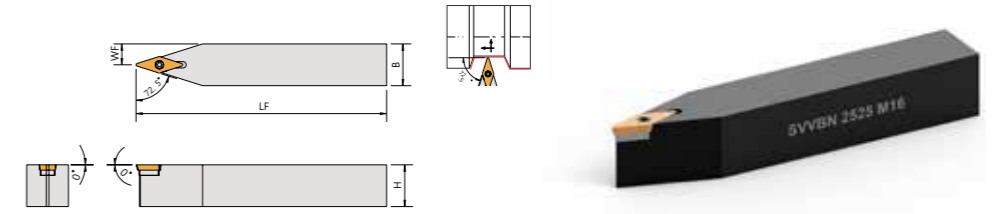

Part Number		Toolholder ISO	Insert	Dimensions (mm)				Price
Neutral				H	B	LF	WF	£
OM12154		SVVBN 2020 K16	VBMT 1604	20	20	125	10	£39.00
OM12155		SVVBN 2525 M16		25	25	150	12.5	£41.00

Spare Parts

Designation	Insert Shim	£	Shim Screw	£	Insert Screw	£	Torx Key	£	Hex Key	£
...16	OM14086 (SMV-321)	£5.90	OM14093 (SN-535)	£2.80	OM14038 (CS-35115)	£2.20	OM14059 (FT-15)	£5.50	OM14068 (LW-035)	£2.00

SVVCN 72.5° VCMT

- External Turning Tools

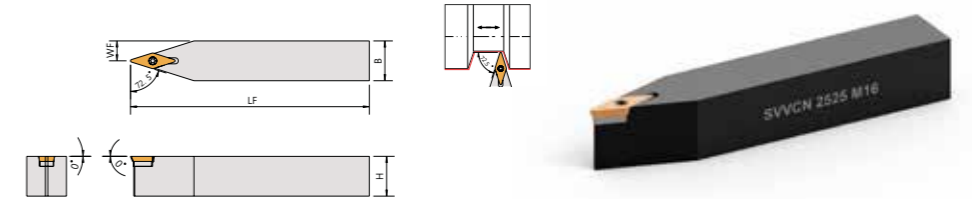

Part Number		Toolholder ISO	Insert	Dimensions (mm)				Price
Neutral				H	B	LF	WF	£
OM12169		SVVCN 2020 K16	VCMT 1604	20	20	125	10	£39.00
OM12170		SVVCN 2525 M16		25	25	150	12.5	£41.00

Spare Parts

Designation	Insert Shim	£	Shim Screw	£	Insert Screw	£	Torx Key	£	Hex Key	£
...16	OM14086 (SMV-321)	£5.90	OM14093 (SN-535)	£2.80	OM14038 (CS-35115)	£2.20	OM14059 (FT-15)	£5.50	OM14068 (LW-035)	£2.00

Mini Carbide Shank Boring Bars SCLCR/L 95° CCGT

- Carbide shank without through coolant

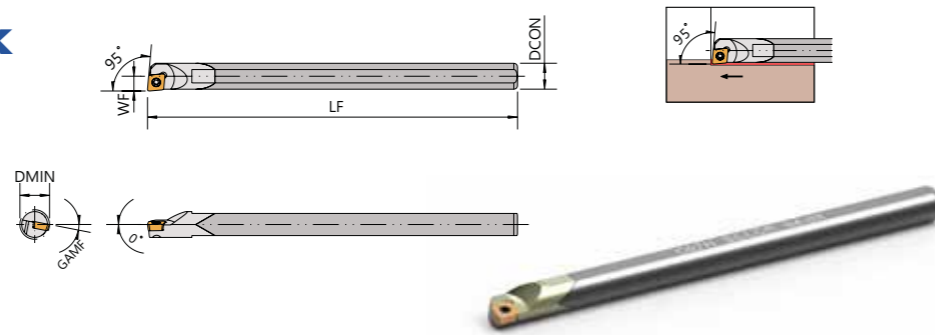

Part Number	Toolholder ISO	Insert	Dimensions (mm)				Price
			DCON (Shank Dia)	WF	LF (Length)	DMIN (Min Bore)	
OM11169	C04G SCLCR 03-05	CCGT 03S1	4	2.5	90	5	£67.00
OM11170	C05H SCLCR 03-06		5	3.0	100	6	£67.00
OM11171	C05H SCLCR 04-06	CCGT 04T0	5	3.0	100	6	£67.00
OM12189	C06J SCLCR 04-07		6	3.5	110	7	£67.00
OM11173	C07K SCLCR 04-08		7	4.0	125	8	£67.00

Mini Carbide Shank Boring Bar Holders

- Toolholder Adaptor Sleeve

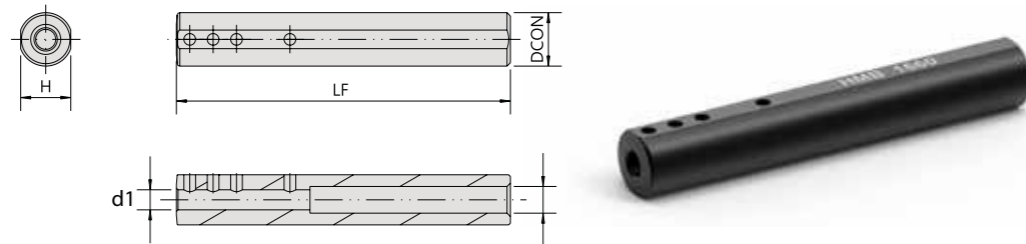

Part Number	Description	Dimensions (mm)			Price
		d1 (Bore Dia)	DCON (Shank Dia)	LF (Length)	
OM14060	HMB 1604	4	16	100	£30.00
OM14061	HMB 1605	5			£30.00
OM14062	HMB 1606	6			£30.00
OM14063	HMB 1607	7			£30.00

Carbide Inserts for Mini Boring Bars GP15 Coated

Part Number	Description	Corner Rad (mm)	Grade	Price
OM15002	CCGT 03S101L	0.1	GP15 Coated	£8.75
OM15003	CCGT 03S102L	0.2		£8.75
OM15004	CCGT 04T001L	0.1		£8.75
OM15005	CCGT 04T002L	0.2		£8.75
OM15066	CCGT 04T004L	0.4		£8.75

Spare Parts

Designation	Insert Screw	£	Torx Key	£
C04G SCLCR/L 03-05	OM14026 (CS-16031)	£2.20	OM14055 (FT6)	£5.50
C05H SCLCR/L 03-06				
C05H SCLCR/L 04-06	OM14028 (CS-20038)	£2.20	OM14055 (FT6)	£5.50
C06H SCLCR/L 04-07				
C07K SCLCR/L 04-08				



S-SCLCR/L 95° CCMT

- Steel shank without through coolant

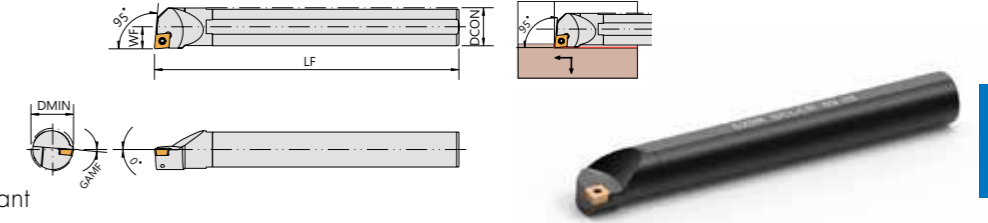

Part Number		Toolholder ISO	Insert	Dimensions (mm)				Price
R/H	L/H			DCON (Shank Dia)	WF	LF (Length)	DMIN (Min Bore)	
OM11001	-	S07K SCLCR/L 06	CCMT 0602	7	4	125	11	£28.00
OM11003	OM11004	S08K SCLCR/L 06		8	5	125	12	£18.00
OM11005	OM11006	S10K SCLCR/L 06		10	7	125	14	£18.00
OM11007	OM11008	S12M SCLCR/L 06		12	9	150	16	£18.00
OM11009	OM11010	S16R SCLCR/L 06		16	11	200	20	£26.00
OM11011	OM11012	S12M SCLCR/L 09	CCMT 09T3	12	9	150	16	£18.00
OM11013	OM11014	S16R SCLCR/L 09		16	11	200	20	£26.00
OM11015	OM11016	S20S SCLCR/L 09		20	13	250	25	£32.00
OM11017	OM11018	S25T SCLCR/L 09		25	17	300	32	£41.00
OM11019	OM11020	S25T SCLCR/L 12	CCMT 1204	25	17	300	32	£48.00
OM11022	OM11023	S32U SCLCR/L 12		32	22	350	40	£74.00
OM11024	OM11025	S40V SCLCR/L 12		40	27	400	50	£109.00

Spare Parts

Designation	Shim	£	Shim Screw	£	Insert Screw	£	Torx Key	£	Hex Key	£
...06	-	-	-	-	OM14030 (CS-25060)	£2.20	OM14056 (FT7)	£5.50	-	-
...09	-	-	-	-	OM14035 (CS-35090)	£2.20	OM14059 (FT-15)	£5.50	-	-
S25T...12	-	-	-	-	OM14042 (CS-40115)	£2.20	OM14059 (FT-15)	£5.50	-	-
S32U...12	OM14075 (SMC-453)	£5.90	OM14094 (SN-630)	£2.80	OM14043 (CS-40145)	£2.20	OM14059 (FT-15)	£5.50	OM14117 (LW-040)	£1.90
S40V...12	OM14075 (SMC-453)	£5.90	OM14094 (SN-630)	£2.80	OM14043 (CS-40145)	£2.20	OM14059 (FT-15)	£5.50	OM14117 (LW-040)	£1.90

A-SCLCR/L 95° CCMT

- Steel shank with through coolant

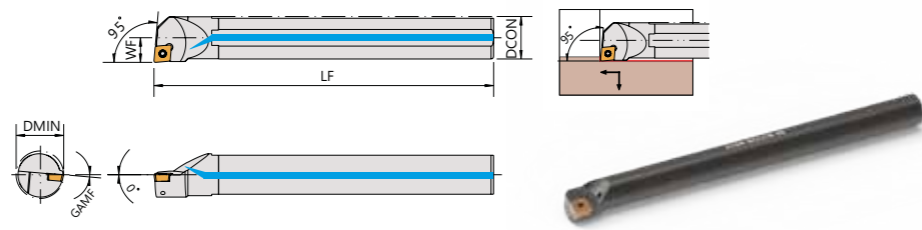

Part Number		Toolholder ISO	Insert	Dimensions (mm)				Price
R/H	L/H			DCON (Shank Dia)	WF	LF (Length)	DMIN (Min Bore)	£
OM11026	OM11027	A08K SCLCR/L 06	CCMT 0602	8	5	125	12	£33.00
OM11028	OM11029	A10K SCLCR/L 06		10	7	125	14	£33.00
OM11030	OM11031	A12M SCLCR/L 06		12	9	150	16	£33.00
OM11032	OM11033	A16M SCLCR/L 09	CCMT 09T3	16	11	150	20	£35.00
OM11034	OM11035	A20Q SCLCR/L 09		20	13	180	25	£42.00
OM11036	OM11037	A25R SCLCR/L 09		25	17	200	32	£53.00

Spare Parts

Designation	Insert Screw	£	Torx Key	£
...06	OM14030 (CS-25060)	£2.20	OM14056 (FT-7)	£5.50
...09	OM14035 (CS-35090)	£2.20	OM14059 (FT-15)	£5.50

A-SCLCR/L 95° CCMT

- Steel shank with through coolant
- Reinforced Shank

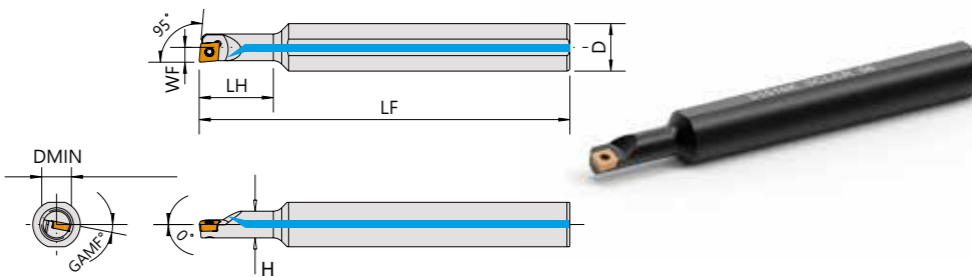

Part Number		Toolholder ISO	Insert	Dimensions (mm)					Price
R/H	L/H			D (Shank Dia)	DMIN (Min Bore)	H (Head Dia)	LF (Length)	LH (Length)	£
OM11300	OM11325	A0608H SCLCR/L 06	CCMT 0602	8	9	6	100	25	£30.00
OM11301	OM11326	A0810J SCLCR/L 06		10	11	8	110	32	£30.00
OM11302	OM11327	A1012K SCLCR/L 06		12	13	10	125	38	£32.00
OM11303	OM11328	A1216M SCLCR/L 06		16	16	12	150	50	£35.00
OM11304	OM11329	A1216M SCLCR/L 09	CCMT 09T3	16	18	12	150	36	£37.00
OM11305	OM11330	A1620Q SCLCR/L 09		20	23	16	180	48	£45.00
OM11306	OM11331	A2025R SCLCR/L 09		25	28	20	200	60	£52.00

Spare Parts

Designation	Insert Screw	£	Torx Key	£
...06	OM14030 (CS-25060)	£2.20	OM14057 (FT-8)	£5.50
...09	OM14035 (CS-35090)	£2.20	OM14059 (FT-15)	£5.50

C-SCLCR/L 95° CCMT

- Carbide Shank without through coolant

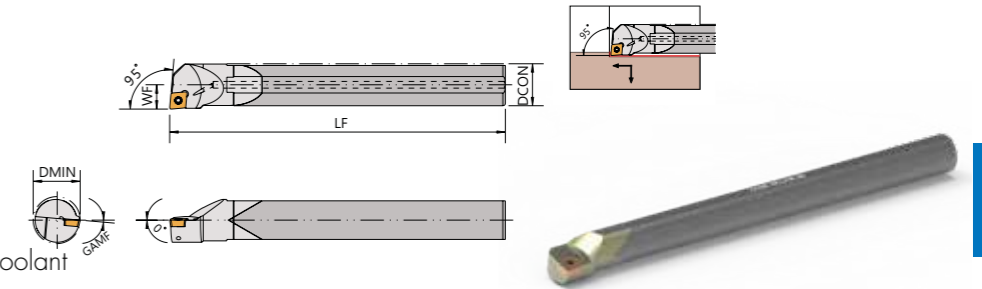

Part Number		Toolholder ISO	Insert	Dimensions (mm)				Price
R/H	L/H			DCON (Shank Dia)	WF	LF (Length)	DMIN (Min Bore)	£
OM11038	OM11039	C08K SCLCR/L 06-10	CCMT 0602	8	5	125	10	£52.00
OM11040	OM11042	C10M SCLCR/L 06-12		10	6	150	12	£62.00
OM11043	OM11045	C12Q SCLCR/L 06-14		12	7	180	14	£79.00
OM11046	OM11049	C16R SCLCR/L 09-18	CCMT 09T3	16	9	200	18	£132.00
OM11050	OM11053	C20S SCLCR/L 09-22		20	11	250	22	£203.00
OM11055	OM11056	C25T SCLCR/L 09-28		25	14.5	300	28	£449.00

Spare Parts

Designation	Insert Screw	£	Torx Key	£
...06	OM14030 (CS-25060)	£2.20	OM14056 (FT-7)	£5.50
C16...09	OM11059 (CS-35075)	£2.20	OM14059 (FT-15)	£5.50
C20...09	OM14035 (CS-35090)	£2.20	OM14059 (FT-15)	£5.50
C25...09	OM14035 (CS-35090)	£2.20	OM14059 (FT-15)	£5.50

E-SCLCR/L 95° CCMT

- Carbide Shank with through coolant

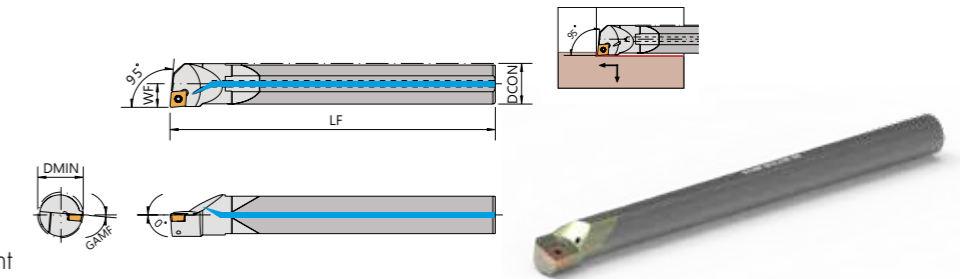

Part Number		Toolholder ISO	Insert	Dimensions (mm)				Price
R/H	L/H			DCON (Shank Dia)	WF	LF (Length)	DMIN (Min Bore)	£
OM11186	OM11187	E08K SCLCR/L 06-10	CCMT 0602	8	5	125	10	£57.00
OM11057	OM11058	E08M SCLCR/L 06-10		8	5	150	10	£79.00
OM11188	OM11189	E10M SCLCR/L 06-14		10	6	150	12	£69.00
OM11060	OM11062	E10Q SCLCR/L 06-12		10	6	180	12	£86.00
OM11190	OM11191	E12Q SCLCR/L 06-16		12	7	180	16	£93.00
OM11064	OM11065	E12R SCLCR/L 06-14		12	7	200	14	£109.00
OM11194	OM11195	E12R SCLCR/L 09-14	CCMT 09T3	12	7	200	14	£110.00
OM11067	OM11068	E16R SCLCR/L 09-18		16	9	200	18	£156.00
OM11069	OM11071	E20S SCLCR/L 09-22		20	11	250	22	£264.00
OM11180	OM11181	E25T SCLCR/L 09-28		25	14.5	300	28	£518.00

Spare Parts

Designation	Insert Screw	£	Torx Key	£
...06	OM14030 (CS-25060)	£2.20	OM14056 (FT-7)	£5.50
E12...09	OM11059 (CS-35075)	£2.20	OM14056 (FT-7)	£5.50
E16...09	OM11059 (CS-35075)	£2.20	OM14059 (FT-15)	£5.50
E20...09	OM14035 (CS-35090)	£2.20	OM14059 (FT-15)	£5.50
E25...09	OM14035 (CS-35090)	£2.20	OM14059 (FT-15)	£5.50

S-SDUCR/L 93° DCMT

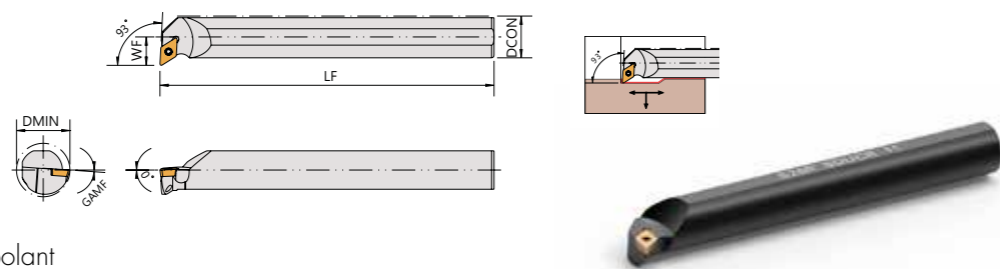

- Steel shank without through coolant

Part Number		Toolholder ISO	Insert	Dimensions (mm)				Price
R/H	L/H			DCON (Shank Dia)	WF	LF (Length)	DMIN (Min Bore)	£
OM11088	OM11089	S10M SDUCR/L 07	DCMT 0702	10	7	150	13	£25.00
OM11090	OM11091	S12M SDUCR/L 07		12	9	150	16	£25.00
OM11092	OM11093	S16R SDUCR/L 07		16	11	200	20	£30.00
OM11094	OM11095	S16R SDUCR/L 11	DCMT 11T3	16	11	200	20	£30.00
OM11096	OM11097	S20S SDUCR/L 11		20	13	250	25	£37.00
OM11098	OM11099	S25T SDUCR/L 11		25	17	300	32	£48.00
OM11100	OM11101	S32U SDUCR/L 11		32	22	350	39	£73.00
OM11271	OM11272	S40T SDUCR/L 11		40	27	300	50	£112.00

Spare Parts

Designation	Insert Screw	£	Torx Key	£
...07	OM14030 (CS-25060)	£2.20	OM14056 (FT-7)	£5.50
...11	OM14035 (CS-35090)	£2.20	OM14059 (FT-15)	£5.50

A-SDUCR/L 93° DCMT

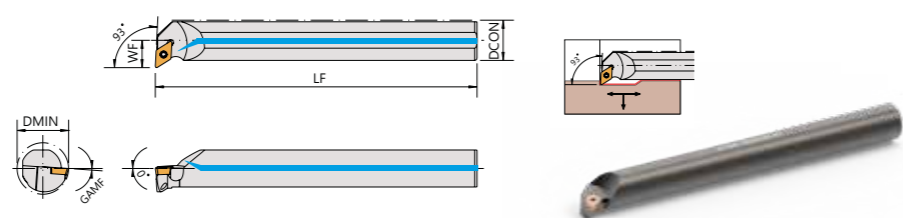

- Steel shank with through coolant

Part Number		Toolholder ISO	Insert	Dimensions (mm)				Price
R/H	L/H			DCON (Shank Dia)	WF	LF (Length)	DMIN (Min Bore)	£
OM11307	OM11314	A10J SDUCR/L 07	DCMT 0702	10	7	110	13	£33.00
OM11348	OM11349	A10M SDUCR/L 07		10	7	150	13	£33.00
OM11308	OM11315	A12K SDUCR/L 07		12	9	125	16	£33.00
OM11350	OM11351	A12M SDUCR/L 07		12	9	150	16	£33.00
OM11309	OM11316	A16M SDUCR/L 07		16	11	150	20	£35.00
OM11352	OM11353	A16Q SDUCR/L 07		16	11	180	20	£35.00
OM11310	OM11317	A20Q SDUCR/L 07		20	13	180	25	£42.00
OM11354	OM11355	A20R SDUCR/L 11	DCMT 11T3	20	13	200	25	£42.00
OM11356	OM11357	A25R SDUCR/L 11		25	17	200	32	£53.00

Spare Parts

Designation	Insert Screw	£	Torx Key	£
...07	OM14030 (CS-25060)	£2.20	OM14056 (FT-7)	£5.50
...11	OM14035 (CS-35090)	£2.20	OM14059 (FT-15)	£5.50

A-SDUCR/L 93° DCMT

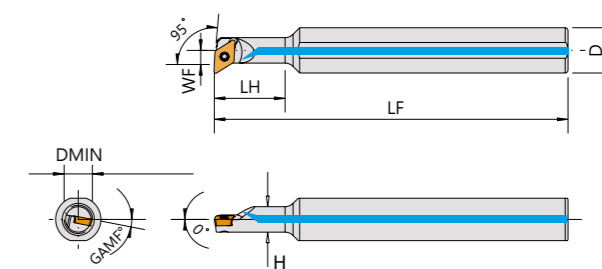

- Steel shank with through coolant
- Reinforced Shank

Part Number		Toolholder ISO	Insert	Dimensions (mm)					Price
R/H	L/H			DCON (Shank Dia)	DMIN (Min Bore)	H (Head Dia)	LF (Length)	LH (Length)	£
OM11311	OM11318	A0810J SDUCR/L 07	DCMT 0702	10	13	8	110	25	£30.00
OM11312	OM11319	A1012K SDUCR/L 07		12	16	10	125	32	£32.00
OM11313	OM11320	A1216M SDUCR/L 07		16	20	12	150	38	£35.00

Spare Parts

Designation	Insert Screw	£	Torx Key	£
07...	OM14030 (CS-25060)	£2.20	OM14056 (FT-7)	£5.50

C-SDUCR/L 93° DCMT

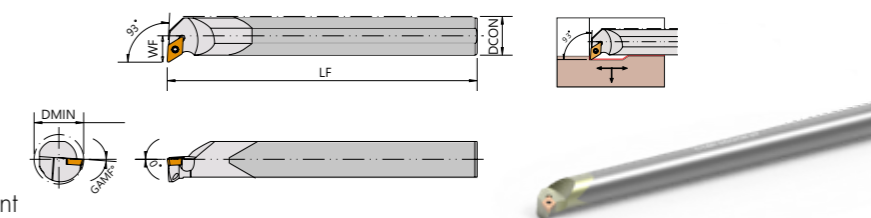

- Carbide shank without through coolant

Part Number		Toolholder ISO	Insert	Dimensions (mm)				Price
R/H	L/H			DCON (Shank Dia)	WF	LF (Length)	DMIN (Min Bore)	£
OM11204	OM11209	C08K SDUCR/L 07	DCMT 0702	8	5	125	13	£62.00
OM11072	OM11073	C10M SDUCR/L 07		10	7	150	13	£62.00
OM11074	OM11075	C12Q SDUCR/L 07		12	9	180	16	£79.00
OM11076	OM11077	C16R SDUCR/L 07		16	11	200	20	£132.00
OM11078	OM11079	C20S SDUCR/L 11	DCMT 11T3	20	13	250	25	£265.00
OM11182	OM11183	C25T SDUCR/L 11		25	17	300	32	£468.00

Spare Parts

Designation	Insert Screw	£	Torx Key	£
...07	OM14030 (CS-25060)	£2.20	OM14056 (FT-7)	£5.50
...11	OM14035 (CS-35090)	£2.20	OM14059 (FT-15)	£5.50

E-SDUCR/L 93° DCMT

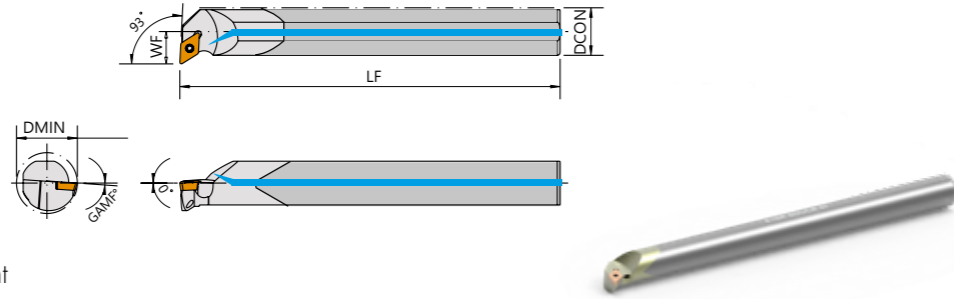

- Carbide shank with through coolant

Part Number		Toolholder ISO	Insert	Dimensions (mm)				Price
R/H	L/H			DCON (Shank Dia)	WF	LF (Length)	DMIN (Min Bore)	£
OM11196	OM11198	E10M SDUCR/L 07	DCMT 0702	10	7	150	13	£69.00
OM11080	OM11081	E10Q SDUCR/L 07		10	7	180	13	£86.00
OM11197	OM11199	E12Q SDUCR/L 07		12	9	180	16	£93.00
OM11082	OM11083	E12R SDUCR/L 07		12	9	200	16	£109.00
OM11084	OM11085	E16R SDUCR/L 07		16	11	200	20	£164.00
OM11086	OM11087	E20S SDUCR/L 11	DCMT 11T3	20	13	250	25	£296.00
OM11184	OM11185	E25T SDUCR/L 11		25	17	300	32	£518.00

Spare Parts

Designation	Insert Screw	£	Torx Key	£
...07	OM14030 (CS-25060)	£2.20	OM14056 (FT-7)	£5.50
...11	OM14035 (CS-35090)	£2.20	OM14059 (FT-15)	£5.50

S-SDQCR/L 107.5° DCMT

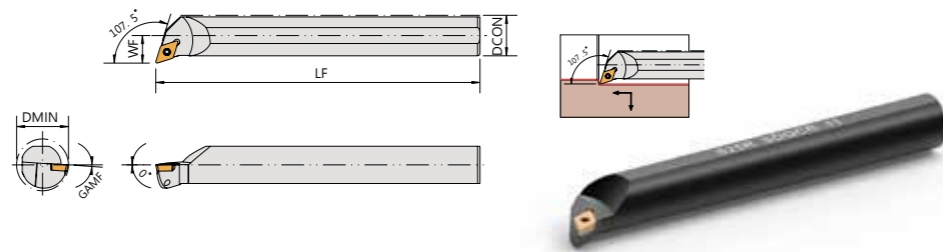

- Steel shank without through coolant

Part Number		Toolholder ISO	Insert	Dimensions (mm)				Price
R/H	L/H			DCON (Shank Dia)	WF	LF (Length)	DMIN (Min Bore)	£
OM11102	OM11103	S10M SDQCR/L 07	DCMT 0702	10	7	150	13	£32.00
OM11104	OM11105	S12M SDQCR/L 07		12	9	150	16	£32.00
OM11106	OM11107	S16R SDQCR/L 07		16	11	200	20	£37.00
OM11108	OM11109	S20S SDQCR/L 11	DCMT 11T3	20	13	250	25	£44.00
OM11273	OM11274	S25R SDQCR/L 11		25	17	200	32	£56.00

Spare Parts

Designation	Insert Screw	£	Torx Key	£
...07	OM14030 (CS-25060)	£2.20	OM14056 (FT-7)	£5.50
...11	OM14035 (CS-35090)	£2.20	OM14059 (FT-15)	£5.50

S-SDZCR/L 93° DCMT

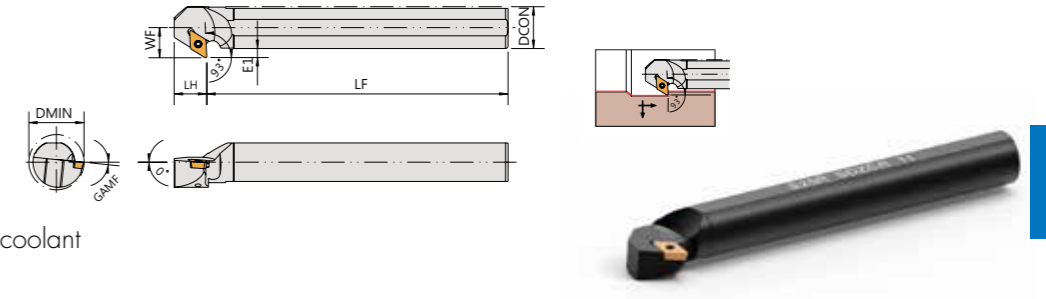

- Steel shank without through coolant

Part Number		Toolholder ISO	Insert	Dimensions (mm)				LH	Price	
R/H	L/H			DCON (Shank Dia)	WF	E1	LF (Length)		DMIN (Min Bore)	£
OM11275	OM11276	S10M SDZCR/L 07	DCMT 0702	10	8.5	3.5	150	14	11	£42.00
OM11277	OM11278	S12M SDZCR/L 07		12	10.5	4.5	150	17	11	£42.00
OM11279	OM11280	S16Q SDZCR/L 07		16	12.5	4.5	180	21	11	£48.00
OM11281	OM11282	S20R SDZCR/L 11	DCMT 11T3	20	15.5	5.5	200	26	16	£56.00
OM11283	OM11284	S25R SDZCR/L 11		25	18	5.5	200	33	20	£68.00

Spare Parts

Designation	Insert Screw	£	Torx Key	£
...07	OM14030 (CS-25060)	£2.20	OM14056 (FT-7)	£5.50
...11	OM14035 (CS-35090)	£2.20	OM14059 (FT-15)	£5.50

S-SVUCR/L 93° VCMT

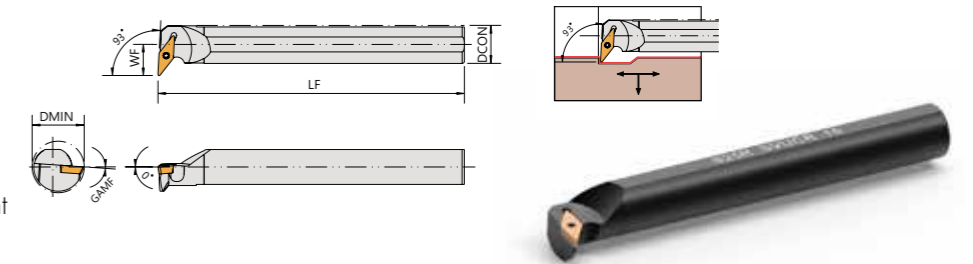

- Steel shank without through coolant

Part Number		Toolholder ISO	Insert	Dimensions (mm)				Price
R/H	L/H			DCON (Shank Dia)	WF	LF (Length)	DMIN (Min Bore)	£
OM11112	OM11113	S16Q SVUCR/L 11	VCMT 1103	16	13	180	22	£39.00
OM11114	OM11115	S20R SVUCR/L 11		20	15	200	27	£49.00
OM11116	OM11117	S25R SVUCR/L 16	VCMT 1604	25	20.5	200	33	£56.00
OM11118	OM11119	S32U SVUCR/L 16		32	22.5	350	42	£79.00
OM11120	OM11121	S40V SVUCR/L 16		40	27	400	51	£112.00

Spare Parts

Designation	Insert Screw	£	Torx Key	£
...11	OM14030 (CS-25060)	£2.20	OM14056 (FT-7)	£5.50
...16	OM14035 (CS-35090)	£2.20	OM14059 (FT-15)	£5.50

A-SVUCR/L 93° VCMT

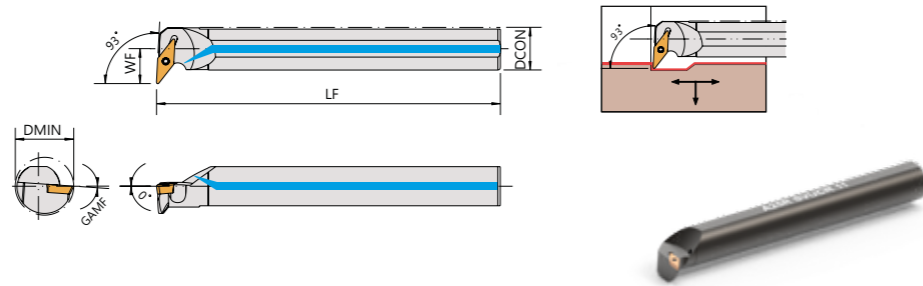

- Steel shank with through coolant

Part Number		Toolholder ISO	Insert	Dimensions (mm)				Price
R/H	L/H			DCON (Shank Dia)	WF	LF (Length)	DMIN (Min Bore)	£
OM11360	OM11361	A16Q SVUCR/L 11	VCMT 1103	16	13	180	22	£46.00
OM11362	OM11363	A20R SVUCR/L 11		20	15	200	27	£58.00
OM11364	OM11365	A25R SVUCR/L 16	VCMT 1604	25	20.5	200	33	£66.00

Spare Parts

Designation	Insert Screw	£	Torx Key	£
...11	OM14030 (CS-25060)	£2.20	OM14056 (FT-7)	£5.50
...16	OM14035 (CS-35090)	£2.20	OM14059 (FT-15)	£5.50

S-SVJCR/L 93° VCMT

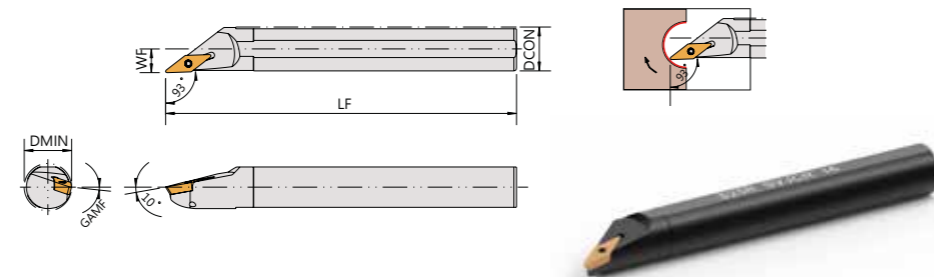

- Steel shank without through coolant

Part Number		Toolholder ISO	Insert	Dimensions (mm)				Price
R/H	L/H			DCON (Shank Dia)	WF	LF (Length)	DMIN (Min Bore)	£
OM11285	OM11286	S12M SVJCR/L 11	VCMT 1103	12	7	150	14	£42.00
OM11287	OM11288	S16Q SVJCR/L 11		16	9	180	18	£48.00
OM11289	OM11290	S20R SVJCR/L 16	VCMT 1604	20	10.5	200	21	£56.00
OM11291	OM11292	S25R SVJCR/L 16		25	13.5	200	27	£68.00

Spare Parts

Designation	Insert Screw	£	Torx Key	£
...11	OM14030 (CS-25060)	£2.20	OM14056 (FT-7)	£5.50
...16	OM14035 (CS-35090)	£2.20	OM14059 (FT-15)	£5.50

S-DCLNR/L 95° CNMG

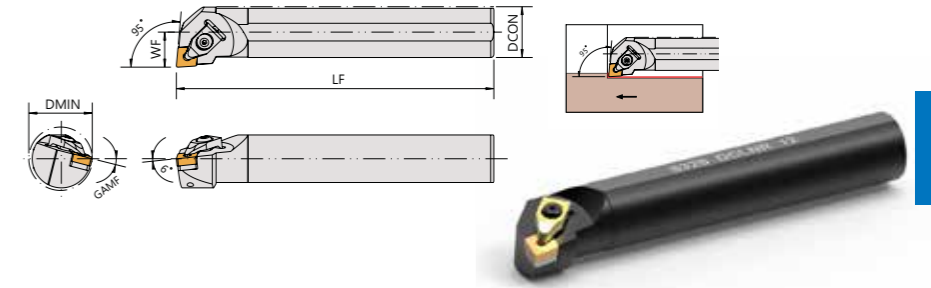

- Steel shank without through coolant

Part Number		Toolholder ISO	Insert	Dimensions (mm)				Price
R/H	L/H			DCON (Shank Dia)	WF	LF (Length)	DMIN (Min Bore)	£
OM11122	OM11123	S25T DCLNR/L 12	CNMG 1204	25	17	300	32	£69.00
OM11124	OM11125	S32S DCLNR/L 12		32	22	250	40	£87.00
OM11126	OM11127	S40T DCLNR/L 12		40	27	300	50	£113.00
OM11178	OM11179	S50W DCLNR/L 12		50	34	450	60	£174.00

Spare Parts

Designation	Insert Shim	£	Shim Screw	£	Insert Clamp	£	Clamp Spring	£	Clamp Screw	£	Torx Key	£
...12	OM14073 (SMC-422)	£5.90	OM14054 (CSF-4010)	£2.20	OM14008 (CP-D4)	£8.60	OM14099 (SP-0816)	£4.80	OM14046 (CSB-0620T)	£2.20	OM14103 (TL-20)	£6.00
S50W...12	OM14278 (MC1204)	£5.90	OM14280 (DSP0612)	£4.50	OM14279 (DCL2612)	£6.00	-	-	OM14105 (DM0625)	£2.20	OM14103 (TL-20)	£6.00

A-DCLNR/L 95° CNMG

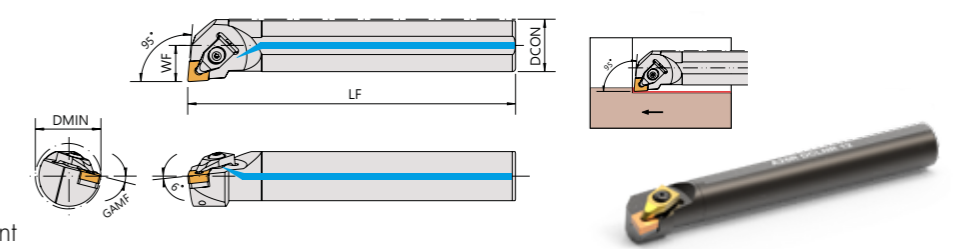

- Steel shank with through coolant

Part Number		Toolholder ISO	Insert	Dimensions (mm)				Price
R/H	L/H			DCON (Shank Dia)	WF	LF (Length)	DMIN (Min Bore)	£
OM11374	OM11375	A25R DCLNR/L 12	CNMG 1204	25	17	200	32	£79.00
OM11376	OM11377	A32S DCLNR/L 12		32	22	250	40	£104.00
OM11378	OM11379	A40T DCLNR/L 12		40	27	300	50	£143.00

Spare Parts

Designation	Insert Shim	£	Shim Screw	£	Insert Clamp	£	Clamp Spring	£	Clamp Screw	£	Torx Key	£
...12	OM14073 (SMC-422)	£5.90	OM14054 (CSF-4010)	£2.20	OM14008 (CP-D4)	£8.60	OM14099 (SP-0816)	£4.80	OM14046 (CSB-0620T)	£2.20	OM14103 (TL-20)	£6.00

S-DDUNR/L 93° DNMG

- Steel shank without through coolant

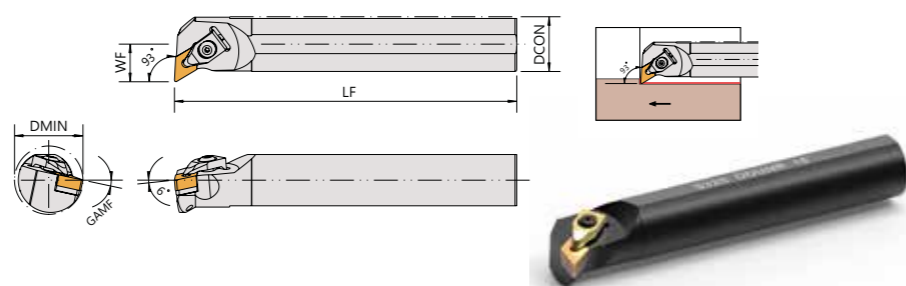

Part Number		Toolholder ISO	Insert	Dimensions (mm)				Price
R/H	L/H			DCON (Shank Dia)	WF	LF (Length)	DMIN (Min Bore)	£
OM11136	OM11137	S25R DDUNR/L 15-06	DNMG 1506	25	17	200	32	£69.00
OM11138	OM11139	S32S DDUNR/L 15-06		32	22	250	40	£92.00
OM11140	OM11141	S40T DDUNR/L 15-06		40	27	300	50	£113.00

Spare Parts

Designation	Insert Shim	£	Shim Screw	£	Insert Clamp	£	Clamp Spring	£	Clamp Screw	£	Torx Key	£
...15	OM14081 (SMD-424)	£5.90	OM14054 (CSF-4010)	£2.20	OM14008 (CP-D4)	£8.60	OM14099 (SP-0816)	£4.80	OM14046 (CSB-0620T)	£2.20	OM14103 (TL-20)	£6.00

For DNMG 1504 inserts use shim OM14082 (SMD-443)

S-DTFNR/L 91° TNMG

- Steel shank without through coolant

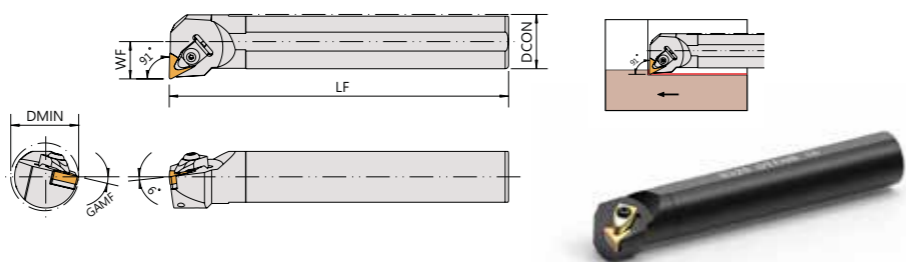

Part Number		Toolholder ISO	Insert	Dimensions (mm)				Price
R/H	L/H			DCON (Shank Dia)	WF	LF (Length)	DMIN (Min Bore)	£
OM11293	OM11294	S25R DTFNR/L 16	TNMG 1604	25	17	200	32	£69.00
OM11295	OM11296	S32S DTFNR/L 16		32	22	250	40	£92.00

Spare Parts

Designation	Insert Shim	£	Shim Screw	£	Insert Clamp	£	Clamp Spring	£	Clamp Screw	£	Torx Key	£
...16	OM11224 (SMT-323)	£5.90	OM14039 (CSA-40075)	£2.20	OM14006 (CP-D2)	£8.60	OM14099 (SP-0816)	£4.80	OM14046 (CSB-0620T)	£2.20	OM14103 (TL-20)	£6.00

S-DVUNR/L 93° VNMG

- Steel shank without through coolant

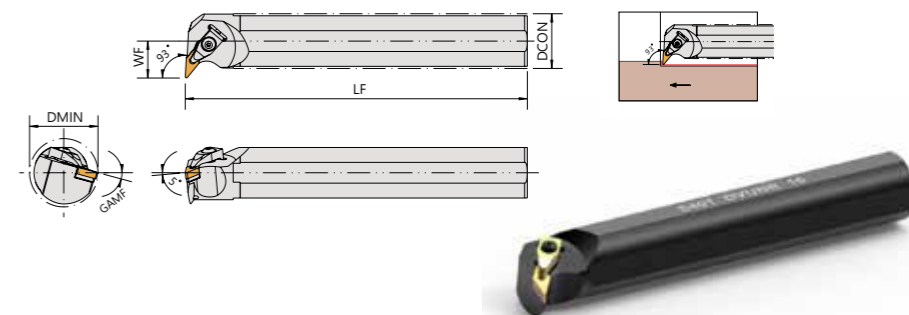

Part Number		Toolholder ISO	Insert	Dimensions (mm)				Price
R/H	L/H			DCON (Shank Dia)	WF	LF (Length)	DMIN (Min Bore)	£
OM11142	OM11143	S40T DVUNR/L 16	VNMG 16	40	27	300	50	£113.00

Spare Parts

Designation	Insert Shim	£	Shim Screw	£	Insert Clamp	£	Clamp Spring	£	Clamp Screw	£	Torx Key	£
...16	OM14087 (SMV-322)	£5.90	OM14040 (CSA-40079)	£2.20	OM14007 (CP-D3)	£8.60	OM14099 (SP-0816)	£4.80	OM14046 (CSB-0620T)	£2.20	OM14103 (TL-20)	£6.00

S-DWLNR/L 95° WNMG

- Steel shank without through coolant

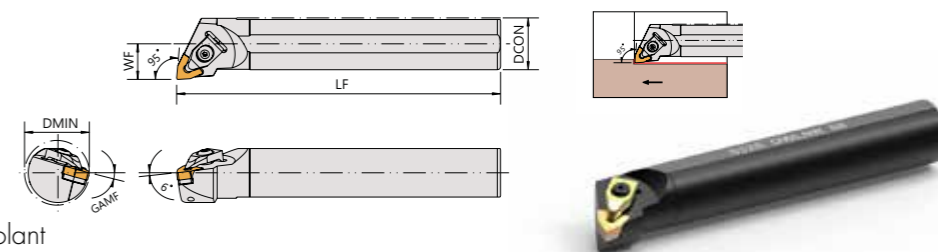

Part Number		Toolholder ISO	Insert	Dimensions (mm)				Price
R/H	L/H			DCON (Shank Dia)	WF	LF (Length)	DMIN (Min Bore)	£
OM11297	OM11298	S20R DWLNR/L 06	WNMG 0604	20	13	200	25	£66.00
OM11145	OM11146	S25R DWLNR/L 06		25	17	200	32	£69.00
OM11147	OM11148	S25R DWLNR/L 08	WNMG 0804	25	17	200	32	£69.00
OM11149	OM11150	S32S DWLNR/L 08		32	22	250	40	£92.00
OM11151	OM11152	S40T DWLNR/L 08		40	27	300	50	£113.00

Spare Parts

Designation	Insert Shim	£	Shim Screw	£	Insert Clamp	£	Clamp Spring	£	Clamp Screw	£	Torx Key	£
...06	OM14089 (SMW-322)	£5.90	OM14053 (CSA-4009F)	£2.20	OM14006 (CP-D2)	£8.60	OM14097 (SP-0612)	£4.80	OM14044 (CSB-0415T)	£2.20	OM14102 (TL-15)	£6.00
...08	OM14090 (SMW-423)	5.90	OM14054 (CSF-4010)	£2.20	OM14008 (CP-D4)	£8.60	OM14099 (SP-0816)	£4.80	OM14046 (CSB-0620T)	£2.20	OM14103 (TL-20)	£6.00

A-DWLNR/L 95° WNMG

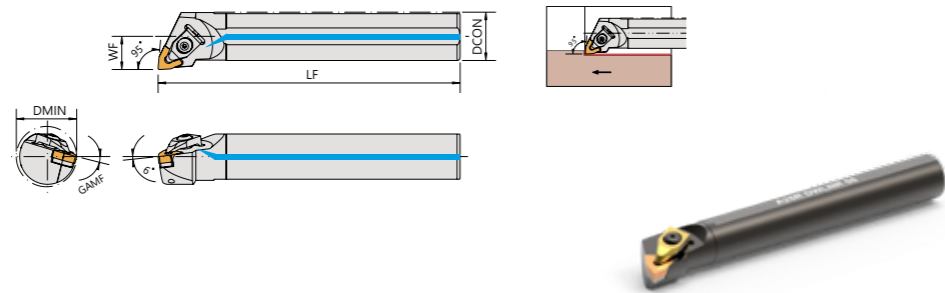

- Steel shank with through coolant

Part Number		Toolholder ISO	Insert	Dimensions (mm)				Price
R/H	L/H			DCON (Shank Dia)	WF	LF (Length)	DMIN (Min Bore)	£
OM11368	OM11369	A20R DWLNR/L 06	WNMG 0604	20	13	200	25	£79.00
OM11370	OM11371	A25R DWLNR/L 08	WNMG 0804	25	17	200	32	£104.00
OM11372	OM11373	A32S DWLNR/L 08		32	22	250	40	£143.00

Spare Parts

Designation	Insert Shim	£	Shim Screw	£	Insert Clamp	£	Clamp Spring	£	Clamp Screw	£	Torx Key	£
...06	-	-	-	-	OM14006 (CP-D2)	£8.60	OM14097 (SP-0612)	£4.80	OM14044 (CSB-0415T)	£2.20	OM14102 (TL-15)	£6.00
...08	OM14090 (SMW-423)	£5.90	OM14054 (CSF-4010)	£2.20	OM14008 (CP-D4)	£8.60	OM14099 (SP-0816)	£4.80	OM14046 (CSB-0620T)	£2.20	OM14103 (TL-20)	£6.00

S-PCLNR/L 95° CNMG

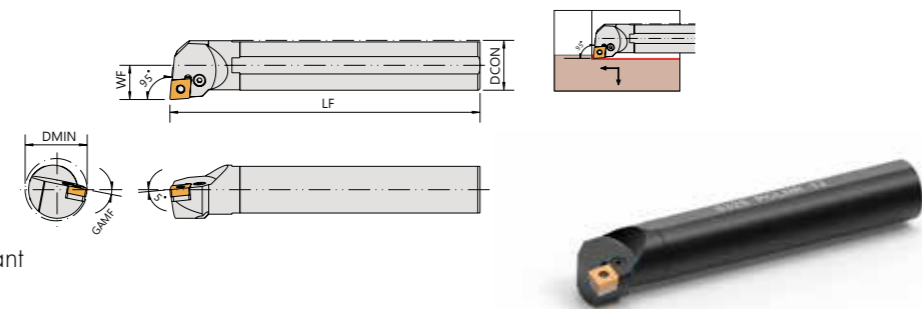

- Steel shank without through coolant

Part Number		Toolholder ISO	Insert	Dimensions (mm)				Price
R/H	L/H			DCON (Shank Dia)	WF	LF (Length)	DMIN (Min Bore)	£
OM11128	OM11129	S25T PCLNR/L 12	CNMG 1204	25	17	300	32	£69.00
OM11130	OM11131	S32U PCLNR/L 12		32	22	350	40	£87.00
OM11132	OM11133	S40V PCLNR/L 12		40	27	400	50	£113.00
OM11134	OM11135	S50W PCLNR/L 12		50	35	450	63	£147.00

Spare Parts

Designation	Insert Shim	£	Shim Clip	£	Insert Lever	£	Lever Screw	£	Hex Key	£
S25 ...12	-	-	OM14024 (CS-LSP5)	£1.60	OM14013 (CP-L15)	£5.70	OM14017 (CS-LS3)	£3.90	OM14066 (LW-025)	£2.00
S32, S40, S50 ...12	OM14073 (SMC-422)	£5.90	OM14023 (CS-LSP4)	£1.60	OM14012 (CP-L14)	£5.70	OM14018 (CS-LS4)	£3.90	OM14067 (LW-030)	£2.00

S-PWLNR/L 95° WNMG

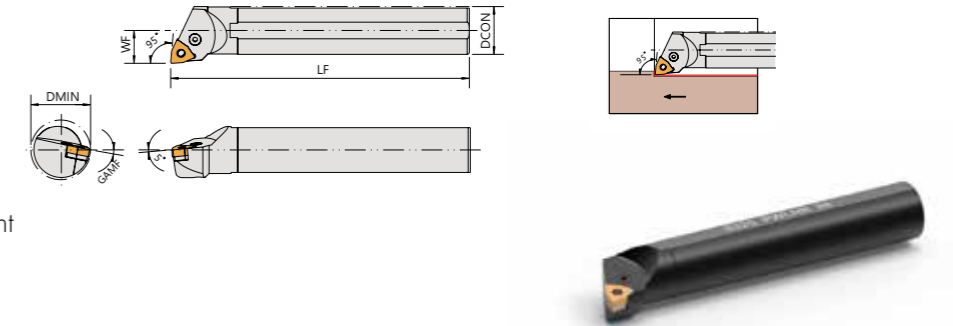

- Steel shank without through coolant

Part Number		Toolholder ISO	Insert	Dimensions (mm)				Price
R/H	L/H			DCON (Shank Dia)	WF	LF (Length)	DMIN (Min Bore)	£
OM11153	OM11154	S16R PWLNR/L 06	WNMG 0604	16	11	200	20	£63.00
OM11155	OM11156	S20S PWLNR/L 06		20	13	250	25	£66.00
OM11157	OM11158	S25T PWLNR/L 06		25	17	300	32	£72.00
OM11159	OM11160	S32U PWLNR/L 06		32	22	350	40	£96.00
OM11161	OM11162	S25T PWLNR/L 08	WNMG 0804	25	17	300	32	£72.00
OM11163	OM11164	S32U PWLNR/L 08		32	22	350	40	£96.00
OM11165	OM11166	S40V PWLNR/L 08		40	27	400	50	£117.00
OM11167	OM11168	S50W PWLNR/L 08		50	34	450	63	£152.00

Spare Parts

Designation	Insert Shim	£	Shim Clip	£	Insert Lever	£	Lever Screw	£	Hex Key	£
...06	-	-	OM14021 (CS-LSP2)	£1.60	OM14010 (CP-L12)	£5.70	OM14016 (CS-LS2)	£3.90	OM14065 (LW-020)	£2.00
S25...08	-	-	OM14024 (CS-LSP5)	£1.60	OM14013 (CP-L15)	£5.70	OM14017 (CS-LS3)	£3.90	OM14066 (LW-025)	£2.00
S32, S40, S50 ...08	OM14090 (SMW-423)	£5.90	OM14023 (CS-LSP4)	£1.60	OM14012 (CP-L14)	£5.70	OM14018 (CS-LS4)	£3.90	OM14067 (LW-030)	£2.00

CARBIDE BORING BAR SET

3 Piece Carbide Shank Boring Bar Set with through coolant

Includes the following boring bars:

- E08K SCLCR/L 06
- E10K SCLCR/L 06
- E12M SCLCR/L 06



Part Number		Description	Insert	Price
R/H	L/H			£
OM01007	OM01008	Carbide Shank SCLCR/L 06 Boring Bar Set	CCMT 06...	£156.00

SCLCR 09 STEEL BORING BAR SET

3 Piece Steel Shank Boring Bar Set with through coolant

Includes the following:

- A1216M SCLCR/L 09
- A1620Q SCLCR/L 09
- A2025R SCLCR/L 09



Part Number		Description	Insert	Price
R/H	L/H			£
OM01002	OM01005	Steel Shank SCLCR/L 09 Boring Bar Set	CCMT 09...	£99.00

SCLCR 06 STEEL BORING BAR SET

4 Piece Steel Shank Boring Bar Set with through coolant

Includes the following:

- A0608H SCLCR 06
- A0810J SCLCR 06
- A1012K SCLCR 06
- A1216M SCLCR 06



Part Number		Description	Insert	Price
R/H	L/H			£
OM01001	OM01004	Steel Shank SCLCR/L 06 Boring Bar Set	CCMT 06...	£99.00

SDUCR 07 STEEL BORING BAR SET

3 Piece Steel Shank Boring Bar Set with through coolant

Includes the following:

- A0810J SDUCR/L 07
- A1012K SDUCR/L 07
- A1216M SDUCR/L 07



Part Number		Description	Insert	Price
R/H	L/H			£
OM01003	OM01006	Steel Shank SDUCR/L 07 Boring Bar Set	DCMT 07...	£95.00

SER/L External Threading

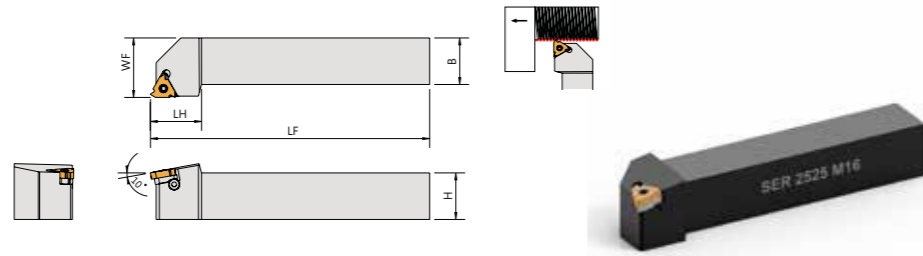

- Size 16 Screwlock

Part Number		Toolholder ISO	Insert	Dimensions (mm)					Price
R/H	L/H			H	B	LF	LH	WF	£
OM13001	OM13002	SER/L 1010 H16N	16ER / 16EL	10	10	100	20	10	£32.00
OM13003	OM13004	SER/L 1212 H16N		12	12	100	20	12	£32.00
OM13005	OM13006	SER/L 1616 H16		16	16	100	20	20	£32.00
OM13007	OM13008	SER/L 2020 K16		20	20	125	20	25	£36.00
OM13009	OM13010	SER/L 2525 M16		25	25	150	29	32	£40.00
OM13011	OM13012	SER/L 3232 P16		32	32	170	32	40	£48.00

Spare Parts

Designation	R/H Shim	£	L/H Shim	£	Shim Screw	£	Insert Screw	£	Torx Key	£	Hex Key	£
...16	OM14001 (AE16)	£6.20	OM14002 (AI16)	£6.20	OM14047 (CSH0306)	£2.20	OM14038 (CS35117S)	£2.20	OM14059 (FT-15)	£5.50	OM14066 (LW025)	2.00

CER/L External Threading

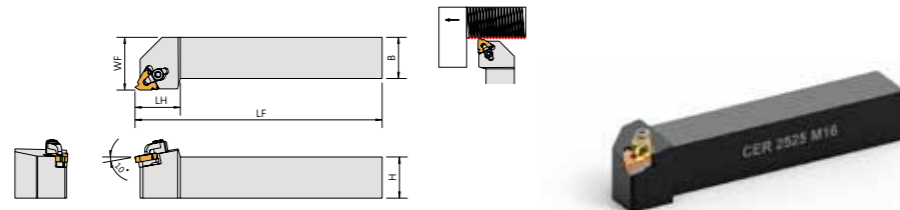

- Size 22+27 Top Clamp

Part Number		Toolholder ISO	Insert	Dimensions (mm)					Price
R/H	L/H			H	B	LF	LH	WF	£
OM13013	OM13014	CER/L 2020 K22	22ER / 22EL	20	20	125	22	25	£43.00
OM13015	OM13016	CER/L 2525 M22		25	25	150	25	32	£46.00
OM13019	OM13020	CER/L 3232 P22		32	32	170	34	40	£62.00
OM13017	OM13018	CER/L 2525 M27	27ER / 27EL	25	25	150	25	32	£82.00
OM13021	OM13022	CER/L 3232 P27		32	32	170	34	40	£92.00
OM13023	OM13024	CER/L 4040 S27		40	40	250	42	50	£98.00

Spare Parts

Designation	R/H Shim	£	L/H Shim	£	Shim Screw	£	Clamp Screw Assembly	£	Torx Key	£	Hex Key	£
...22	OM14003 (AIE22)	£6.90	OM14003 (AIE22)	£6.90	OM14048 (CSF-3008)	£2.20	OM14100 (SP-CP22S)	£8.00	OM14059 (FF-15)	£5.50	OM14065 (LW020)	£2.00
...27	OM14004 (AE27)	£10.80	OM14005 (AI27)	£10.80	OM14054 (CSF-4010)	£2.20	OM14101 (SP-CP27S)	£10.00	OM14117 (LW040)	£2.00	OM14066 (LW025)	£2.00

SIR/L Internal Threading

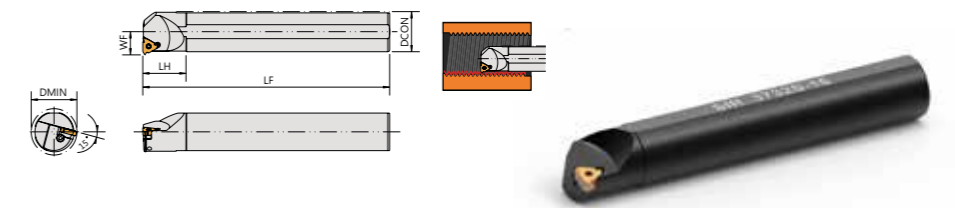

- Size 11,16+22 Screwlock

Part Number		Toolholder ISO	Insert	Dimensions (mm)					Price
R/H	L/H			DCON (Shank Dia)	WF	LF (Length)	DMIN (Min Bore)	LH	£
OM13025	OM13026	SIR/L 1010 11	11 IR/L	10	5.2	150	10	25	£33.00
OM13027	OM13028	SIR/L 1012 11		12	5.2	150	10	25	£33.00
OM13071	OM13072	SIR/L 1412 11		12	7.5	150	14	25	£34.00
OM13029	OM13030	SIR/L 1216 11		16	6.3	150	12	25	£34.00
OM13073	OM13074	SIR/L 1516 16	16 IR/L	16	8.2	150	15	35	£35.00
OM13031	OM13032	SIR/L 2016 16		16	10	150	20	35	£35.00
OM13033	OM13034	SIR/L 2420S 16		20	12	180	24	35	£40.00
OM13035	OM13036	SIR/L 3025S 16		25	15	200	30	35	£46.00
OM13037	OM13038	SIR/L 3732S 16		32	18.5	250	37	35	£60.00
OM13039	OM13040	SIR/L 4440S 16		40	22.5	300	44	35	£97.00
OM11380	OM11381	SIR/L 5550S 16		50	28.5	350	55	35	£168.00
OM13041	OM13042	SIR/L 2420 22		22IR/L	20	13	180	24	35

Spare Parts

Designation	R/H Shim	£	L/H Shim	£	Shim Screw	£	Insert Screw	£	Torx Key	£	Hex Key	£
...11	-	-	-	-	-	-	OM14033 (CS-25080)	£2.20	OM14057 (FT-8)	£5.50	-	-
...16 16	-	-	-	-	-	-	OM14035 (CS-35090)	£2.20	OM14059 (FT-15)	£5.50	-	-
... S 16	OM14002 (AI16)	£6.20	OM14001 (AE16)	£6.20	OM14047 (CSH0306)	£2.20	OM14038 (CS-35115)	£2.20	OM14059 (FT-15)	£5.50	OM14066 (LW025)	£2.00
...2420 22	-	-	-	-	-	-	OM14042 (CS-40115)	£2.20	OM14059 (FT-15)	£5.50	-	-

CNR/L Internal Threading

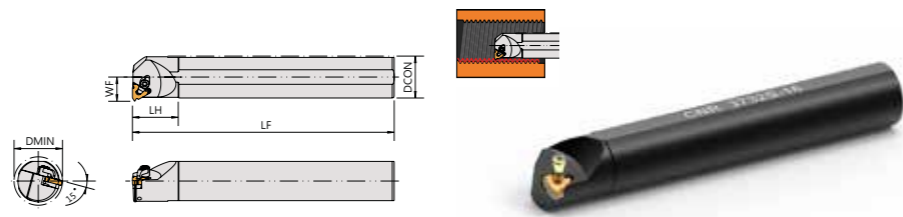

- Size 22+27 Top Clamp

Part Number		Toolholder ISO	Insert	Dimensions (mm)					Price
R/H	L/H			DCON (Shank Dia)	WF	LF (Length)	DMIN (Min Bore)	LH	£
OM13043	OM13044	CNR/L 3025S 22	22IR/L	25	16	200	30	35	£56.00
OM13045	OM13046	CNR/L 3732S 22		32	19.5	250	37	35	£71.00
OM13049	OM13050	CNR/L 4440S 22		40	24.5	300	45	35	£104.00
OM11382	OM11383	CNR/L 5450S 22		50	30.5	350	56	35	£178.00
OM13047	OM13048	CNR/L 3732 S27	27 IR/L	32	20	250	37	35	£89.00
OM13051	OM13052	CNR/L 4440 S27		40	25	300	46	35	£142.00
OM13053	OM13054	CNR/L 5450 S27		50	31.5	350	58	35	£178.00

Spare Parts

Designation	R/H Shim	£	L/H Shim	£	Shim Screw	£	Clamp Screw Assembly	£	Torx Key	£	Hex Key	£
...22	OM14003 (AIE22)	£6.90	OM14003 (AIE22)	£6.90	OM14048 (CSF-3008)	£2.20	OM14100 (SP-CP22S)	£8.00	OM14059 (FT15)	£5.50	OM14065 (LW020)	£2.00
...27	OM14005 (AI27)	£10.80	OM14004 (AE27)	£10.80	OM14054 (CSF-4010)	£2.20	OM14101 (SP-CP27S)	£10.00	OM14117 (LW040)	£2.00	OM14066 (LW025)	£2.00

C-SIR Internal Threading

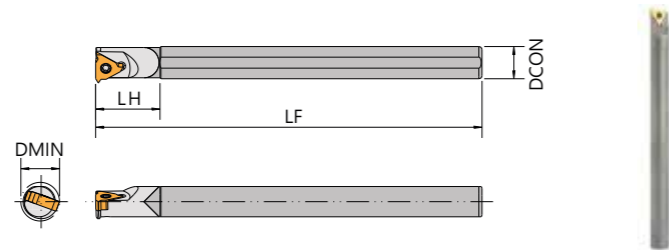

- Carbide Shank Threading Tools

Part Number	Toolholder ISO	Insert	DCON (Shank Dia)	LF (Length)	DMIN (Min Bore)	LH	£
OM13068	C10M SIR11-12	11 IR	10	150	12	18	£98.00
OM13069	C12Q SIR11-14		12	180	14	25	£135.00
OM13070	C16R SIR16-20	16 IR	16	200	20	35	£198.00
OM13076	C20S SIR24-20S16		20	250	24	35	£365.00

Spare Parts

Designation	Shim	£	Shim Screw	£	Insert Screw	£	Torx Key	£	Hex Key	£
C10/C12	-	-	-	-	OM14033 (CS-25080)	£2.20	OM14057 (FT8)	£5.50	-	-
C16	-	-	-	-	OM14035 (CS-35090)	£2.20	OM14059 (FT15)	£5.50	-	-
C20	OM14002 (AI16)	£6.20	OM14047 (CSH-0306)	£2.20	OM14038 (CS-35115)	£2.20	OM14059 (FT15)	£5.50	OM14066 (LW025)	£2.00

PART OFF BLOCKS Removable Split Block Type

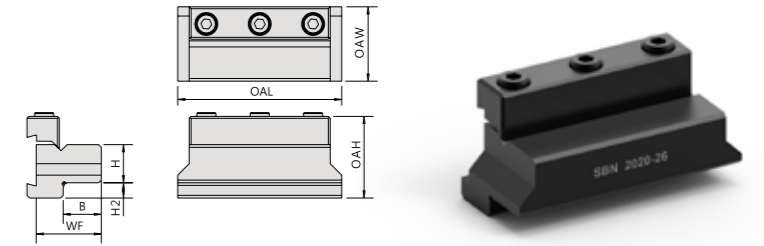

Part Number	Description	Dimensions (mm)							Price
		H	B	WF	OAH	OAW	H2	OAL	£
OM13055	SBN 1216-26	12	16	30.5	42	35	16	86	£52.00
OM13056	SBN 1616-26	16	16	30.5	42	35	12	86	£52.00
OM13057	SBN 2020-26	20	20	32.5	42	39	8	86	£52.00
OM13059	SBN 2520-26	25	20	34.5	42	39	3	86	£52.00
OM13058	SBN 2020-32	20	20	34.5	47	40	13	110	£52.00
OM13060	SBN 2520-32	25	20	34.5	47	40	8	110	£52.00
OM13061	SBN 3230-32	32	30	34.5	47	50	8	110	£52.00

PART OFF BLADES 26mm & 32mm Height

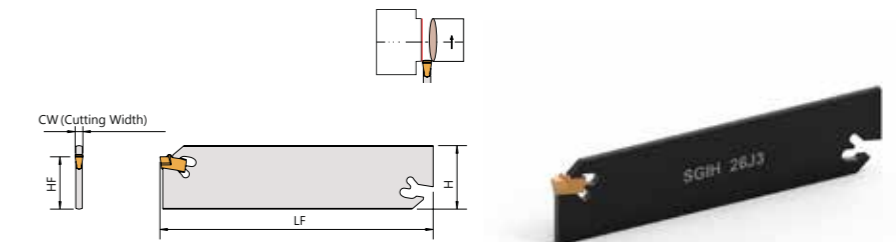

Part Number	Description	Insert	Dimensions (mm)				Price
			HW	CW	HF	LF	£
OM13062	SGIH 26J2	OP22	26	2.2	21.4	110	£31.00
OM13075	SGIH 32M2		32	2.2	25	150	£31.00
OM13063	SGIH 26J3	OP30	26	3	21.4	110	£31.00
OM13064	SGIH 32M3		32	3	25	150	£31.00
OM13065	SGFH 26J2	GFN2	26	2.0 / 2.2	21.4	110	£31.00
OM13066	SGFH 26J3	GFN3	26	3	21.4	110	£31.00
OM13067	SGFH 32M3		32	3	25	150	£31.00

Spare Parts

Designation	Insert Wrench	£
SGIH..	OM14115 (SL4)	£8.50
SGFH..	OM14287 (SL3)	£8.50

PART OFF INSERTS 2mm & 3mm Neutral

- For SGIH Part Off Blades

Part Number	Description	Size	Coating	Price
				£
OM15067	OP22N M20TIALN	2.2mm	M20 TiALN	£6.75
OM15068	OP30N M20TIALN	3mm	M20 TiALN	£7.35

APKT END MILLS

For APKT 10..
Milling Inserts

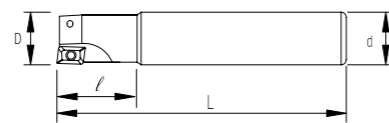

Part Number	Toolholder ISO	Insert	Dimensions (mm)				Z	Price
			Cutter Dia (D)	Shank Dia (d)	Length (L)	Reach (l)		£
OM13205	S-E90AP1003-D16G02	APKT 1003	16	16	90	28	2	£39.00
OM13206	S-E90AP1003-D20J03		20	20	110	28	3	£46.00
OM13207	S-E90AP1003-D25K04		25	25	125	28	4	£49.00
OM13208	S-E90AP1003-D32K05		32	32	125	28	5	£53.00

Milling Inserts



Part Number	Description	Coating	Price
OM15001	APKT1003 PDER MM OP3040	PVD Multi-Layer TiAlN	£5.80

Spare Parts

Designation	Insert Screw	£	Torx Key	£
S-E90...D16	OM14031 (CS-25055)	£2.20	OM14274 (SDT8)	£5.50
S-E90...D20				
S-E90...D25	OM14032 (CS-25065)	£2.20	OM14274 (SDT8)	£5.50
S-E90...D32				

WCGX U-DRILLS

Indexable Drills for WCGX inserts

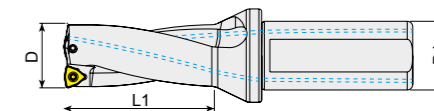

Part Number	Description	Insert	D	D1	L1	Price
OM14501	UD30.WC03.160.W25	WCGX 030208	16	25	52	£73.00
OM14502	UD30.WC03.170.W25		17	25	55	£73.00
OM14503	UD30.WC03.180.W25		18	25	58	£73.00
OM14504	UD30.WC03.190.W25		19	25	61	£73.00
OM14505	UD30.WC03.200.W25		20	25	64	£92.00
OM14506	UD30.WC04.210.W25	WCGX 040208	21	25	67	£92.00
OM14507	UD30.WC04.220.W25		22	25	70	£92.00
OM14508	UD30.WC04.230.W25		23	25	73	£92.00
OM14509	UD30.WC04.240.W25		24	25	76	£92.00
OM14510	UD30.WC04.250.W25		25	25	79	£92.00
OM14511	UD30.WC05.260.W32	WCGX 050308	26	32	83	£104.00
OM14512	UD30.WC05.270.W32		27	32	86	£104.00
OM14513	UD30.WC05.280.W32		28	32	89	£104.00
OM14514	UD30.WC05.290.W32		29	32	92	£104.00
OM14515	UD30.WC05.300.W32		30	32	95	£104.00
OM14516	UD30.WC06.310.W40	WCGX 06T308	31	40	98	£115.00
OM14517	UD30.WC06.320.W40		32	40	101	£115.00
OM14518	UD30.WC06.330.W40		33	40	104	£115.00
OM14519	UD30.WC06.340.W40		34	40	107	£115.00
OM14520	UD30.WC06.350.W40		35	40	110	£115.00
OM14521	UD30.WC06.360.W40	WCGX 080412	36	40	113	£115.00
OM14522	UD30.WC06.370.W40		37	40	116	£125.00
OM14523	UD30.WC06.380.W40		38	40	119	£125.00
OM14524	UD30.WC06.390.W40		39	40	122	£125.00
OM14525	UD30.WC06.400.W40		40	40	125	£125.00
OM14526	UD30.WC06.410.W40	WCGX 080412	41	40	128	£125.00
OM14527	UD30.WC08.420.W40		42	40	131	£146.00
OM14528	UD30.WC08.430.W40		43	40	134	£146.00
OM14529	UD30.WC08.440.W40		44	40	137	£157.00
OM14530	UD30.WC08.450.W40		45	40	140	£157.00
OM14531	UD30.WC08.460.W40	WCGX 080412	46	40	143	£157.00
OM14532	UD30.WC08.470.W40		47	40	146	£157.00
OM14533	UD30.WC08.480.W40		48	40	149	£157.00
OM14534	UD30.WC08.490.W40		49	40	152	£157.00
OM14535	UD30.WC08.500.W40		50	40	155	£157.00

WCGX U-Drill Inserts

Part Number	Description	Coating	Price
OM15069	WCGX 030208	BPG20B	£3.95
OM15070	WCGX 040208	BPG20B	£4.15
OM15071	WCGX 050308	BPG20B	£4.35
OM15072	WCGX 06T308	BPG20B	£4.95
OM15073	WCGX 080412	BPG20B	£6.25

Spare Parts

Insert Screw	£	Torx Key	£
OM14032 (CS-25065)	£2.20	OM14057 (FT8)	£5.50
OM14032 (CS-25065)	£2.20	OM14057 (FT8)	£5.50
OM14034 (CS-30080)	£2.20	OM14058 (FT10)	£5.50
OM14035 (CS-35090)	£2.20	OM14059 (FT15)	£5.50
OM14042 (CS-40115)	£2.20	OM14059 (FT15)	£5.50

SPMG INDEXABLE U-DRILLS

- Excellent diameter accuracy
- Unique insert design to control chip flow
- Made from high quality H13 material



INDEXABLE DRILLS U-DRILLS - 2XD

- Excellent diameter accuracy
- Unique insert design to control chip flow
- Made from high quality H13 material

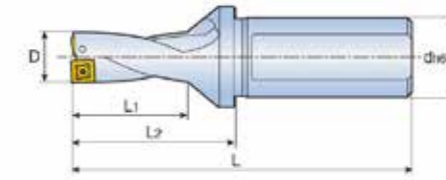

Part Number	Description	Diameter (D)	Flute Length (L1)	Overall Length (L)	L2	Shank Size (dh6)	for Inserts	Screw Size	Torx Key	Price				
OM23701	SPMG13-S20-2D	13	26	94	44	20	SPMG 05 / SPGG 05	M2.0X5	T6	£48.00				
OM23703	SPMG14-S25-2D	14	28	96	46					£48.00				
OM23705	SPMG15-S25-2D	15	30	99	49					£48.00				
OM23707	SPMG16-S25-2D	16	32	108	52					£48.00				
OM23709	SPMG17-S25-2D	17	34	110	54					£48.00				
OM23711	SPMG18-S25-2D	18	36	113	57					£52.00				
OM23713	SPMG19-S25-2D	19	38	115	59					£52.00				
OM23715	SPMG20-S25-2D	20	40	119	63					£52.00				
OM23717	SPMG21-S25-2D	21	42	121	65					£52.00				
OM23719	SPMG22-S25-2D	22	44	123	67					£58.00				
OM23721	SPMG23-S25-2D	23	46	131	71	25	SPMG 06 / SPGG 06	M2.2X5.5	T7	£58.00				
OM23725	SPMG24-S25-2D	24	48	134	74					£58.00				
OM23728	SPMG25-S32-2D	25	50	137	77					£58.00				
OM23730	SPMG26-S32-2D	26	52	139	79					£58.00				
OM23732	SPMG27-S32-2D	27	54	142	81					£62.00				
OM23734	SPMG28-S32-2D	28	56	144	84					£62.00				
OM23736	SPMG29-S32-2D	29	58	146	86					£62.00				
OM23738	SPMG30-S32-2D	30	60	148	88					£62.00				
OM23739	SPMG31-S32-2D	31	62	150	90					£68.00				
OM23740	SPMG32-S32-2D	32	64	152	92					£68.00				
OM23741	SPMG33-S32-2D	33	66	154	94	32	SPMG 07 / SPGG 07	M2.5X8	T8	£68.00				
OM23742	SPMG34-S32-2D	34	68	156	96					£68.00				
OM23744	SPMG35-S32-2D	35	70	158	98					£72.00				
OM23746	SPMG36-S32-2D	36	72	160	100					£72.00				
OM23748	SPMG37-S32-2D	37	74	162	102					£72.00				
OM23750	SPMG38-S32-2D	38	76	164	104					£72.00				
OM23752	SPMG39-S32-2D	39	78	166	106					£72.00				
OM23754	SPMG40-S32-2D	40	80	185	115					£76.00				
OM23756	SPMG41-S32-2D	41	82	187	117					£76.00				
OM23758	SPMG42-S40-2D	42	84	189	119					£76.00				
OM23759	SPMG43-S40-2D	43	86	191	121	40	SPMG 09 / SPGG 09	M3.5X9	T15	£82.00				
OM23760	SPMG44-S40-2D	44	88	193	123					£82.00				
OM23761	SPMG45-S40-2D	45	90	195	125					£86.00				
OM23762	SPMG46-S40-2D	46	92	197	127					£86.00				
OM23763	SPMG47-S40-2D	47	94	199	129					£90.00				
OM23764	SPMG48-S40-2D	48	96	201	131					£90.00				
OM23765	SPMG49-S40-2D	49	98	203	133					£92.00				
OM23766	SPMG50-S40-2D	50	100	205	135					£92.00				
										40	SPMG 11 / SPGG 11	M4.0X10	T15	£92.00
														£76.00
						£82.00								
						£82.00								
						£86.00								
						£86.00								
						£90.00								
						£90.00								
						£92.00								
						£92.00								
						40	SPMG 14 / SPGG 14	M5.0X11	T20	£86.00				
										£90.00				
										£90.00				
										£92.00				
										£92.00				
										£92.00				
										£92.00				
										£92.00				
										£92.00				
										£92.00				

INDEXABLE DRILLING

INDEXABLE DRILLS U-DRILLS - 3XD

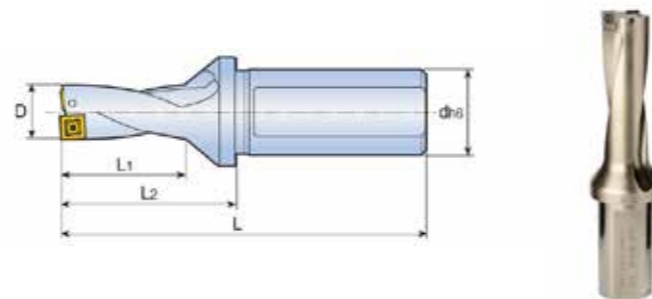

- Excellent diameter accuracy
- Unique insert design to control chip flow
- Made from high quality H13 material

Part Number	Description	Diameter (D)	Flute Length (L1)	Overall Length (L)	L2	Shank Size (dh6)	for Inserts	Screw Size	Torx Key	Price
OM23768	SPMG13-S20-3D	13	39	125	69	20	SPMG 05 / SPGG 05	M2.0X5	T6	£48.00
OM23770	SPMG14-S25-3D	14	42	128	72					£48.00
OM23772	SPMG15-S25-3D	15	45	131	75					£48.00
OM23774	SPMG16-S25-3D	16	48	134	78					£48.00
OM23776	SPMG17-S25-3D	17	51	137	81					£48.00
OM23778	SPMG18-S25-3D	18	54	140	84					£52.00
OM23780	SPMG19-S25-3D	19	57	143	87		SPMG 06 / SPGG 06	M2.2X5.5	T7	£52.00
OM23782	SPMG20-S25-3D	20	60	146	90					£52.00
OM23784	SPMG21-S25-3D	21	63	158	98					£52.00
OM23786	SPMG22-S25-3D	22	66	161	101					£58.00
OM23788	SPMG23-S25-3D	23	69	164	104					£58.00
OM23792	SPMG24-S25-3D	24	72	167	107					£58.00
OM23795	SPMG25-S32-3D	25	75	170	110	SPMG 07 / SPGG 07	M2.5X8	T8	£58.00	
OM23797	SPMG26-S32-3D	26	78	173	113				£58.00	
OM23799	SPMG27-S32-3D	27	81	176	116				£62.00	
OM23801	SPMG28-S32-3D	28	84	179	119				£62.00	
OM23803	SPMG29-S32-3D	29	87	182	122				£62.00	
OM23805	SPMG30-S32-3D	30	90	185	125				£62.00	
OM23806	SPMG31-S32-3D	31	93	188	128	SPMG 09 / SPGG 09	M3.5X9	T15	£68.00	
OM23807	SPMG32-S32-3D	32	96	191	131				£68.00	
OM23808	SPMG33-S32-3D	33	99	194	134				£68.00	
OM23809	SPMG34-S32-3D	34	102	197	137				£68.00	
OM23811	SPMG35-S32-3D	35	105	200	140				£72.00	
OM23813	SPMG36-S32-3D	36	108	203	143				£72.00	
OM23815	SPMG37-S32-3D	37	111	206	146	SPMG 11 / SPGG 11	M4.0X10	T15	£72.00	
OM23817	SPMG38-S32-3D	38	114	209	149				£72.00	
OM23819	SPMG39-S32-3D	39	117	212	152				£72.00	
OM23821	SPMG40-S32-3D	40	120	215	155				£76.00	
OM23823	SPMG41-S32-3D	41	123	218	158				£76.00	
OM23825	SPMG42-S40-3D	42	126	221	161				£76.00	
OM23826	SPMG43-S40-3D	43	129	239	169	40	SPMG 14 / SPGG 14	M5.0X11	T20	£82.00
OM23827	SPMG44-S40-3D	44	132	242	172					£82.00
OM23828	SPMG45-S40-3D	45	135	245	175					£86.00
OM23829	SPMG46-S40-3D	46	138	248	178					£86.00
OM23830	SPMG47-S40-3D	47	141	251	181					£90.00
OM23831	SPMG48-S40-3D	48	144	254	184					£90.00
OM23832	SPMG49-S40-3D	49	147	257	187					£92.00
OM23833	SPMG50-S40-3D	50	150	260	190					£92.00

INDEXABLE DRILLS U-DRILLS - 4XD

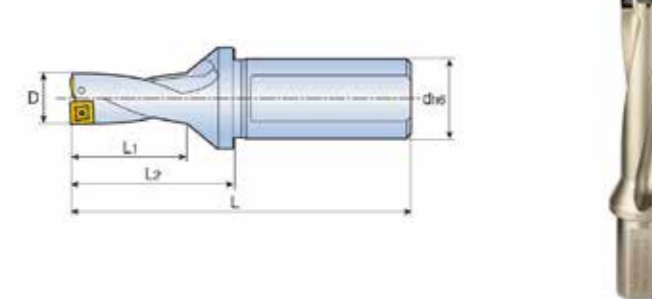

- Excellent hole diameter accuracy
- Unique insert design to control chip flow
- Made from high quality H13 material

Part Number	Description	Diameter (D)	Flute Length (L1)	Overall Length (L)	L2	Shank Size (dh6)	for Inserts	Screw Size	Torx Key	Price
OM23835	SPMG13-S20-4D	13	52	138	82	20	SPMG 05 / SPGG 05	M2.0X5	T6	£54.00
OM23837	SPMG14-S25-4D	14	56	142	86					£54.00
OM23839	SPMG15-S25-4D	15	60	146	90					£54.00
OM23841	SPMG16-S25-4D	16	64	150	94					£54.00
OM23843	SPMG17-S25-4D	17	68	154	98					£54.00
OM23845	SPMG18-S25-4D	18	72	158	102					£58.00
OM23847	SPMG19-S25-4D	19	76	162	106		SPMG 06 / SPGG 06	M2.2X5.5	T7	£58.00
OM23849	SPMG20-S25-4D	20	80	166	110					£58.00
OM23851	SPMG21-S25-4D	21	84	179	119					£58.00
OM23853	SPMG22-S25-4D	22	88	183	123					£62.00
OM23855	SPMG23-S25-4D	23	92	187	127					£62.00
OM23859	SPMG24-S25-4D	24	96	191	131					£62.00
OM23862	SPMG25-S32-4D	25	100	195	135	SPMG 07 / SPGG 07	M2.5X8	T8	£62.00	
OM23864	SPMG26-S32-4D	26	104	199	139				£62.00	
OM23866	SPMG27-S32-4D	27	108	203	143				£68.00	
OM23868	SPMG28-S32-4D	28	112	207	147				£68.00	
OM23870	SPMG29-S32-4D	29	116	211	151				£68.00	
OM23872	SPMG30-S32-4D	30	120	215	155				£68.00	
OM23873	SPMG31-S32-4D	31	124	219	159	SPMG 09 / SPGG 09	M3.5X9	T15	£74.00	
OM23874	SPMG32-S32-4D	32	128	223	163				£74.00	
OM23875	SPMG33-S32-4D	33	132	227	167				£74.00	
OM23876	SPMG34-S32-4D	34	136	231	171				£74.00	
OM23878	SPMG35-S32-4D	35	140	235	175				£78.00	
OM23880	SPMG36-S32-4D	36	144	239	179				£78.00	
OM23882	SPMG37-S32-4D	37	148	243	183	SPMG 11 / SPGG 11	M4.0X10	T15	£78.00	
OM23884	SPMG38-S32-4D	38	152	247	187				£78.00	
OM23886	SPMG39-S32-4D	39	156	251	191				£78.00	
OM23888	SPMG40-S32-4D	40	160	255	195				£84.00	
OM23890	SPMG41-S32-4D	41	164	259	199				£84.00	
OM23892	SPMG42-S40-4D	42	168	263	203				£84.00	
OM23893	SPMG43-S40-4D	43	172	282	212	40	SPMG 14 / SPGG 14	M5.0X11	T20	£90.00
OM23894	SPMG44-S40-4D	44	176	286	216					£90.00
OM23895	SPMG45-S40-4D	45	180	290	220					£98.00
OM23896	SPMG46-S40-4D	46	184	294	224					£98.00
OM23897	SPMG47-S40-4D	47	188	298	228					£114.00
OM23898	SPMG48-S40-4D	48	192	302	232					£114.00
OM23899	SPMG49-S40-4D	49	196	306	236					£118.00
OM23900	SPMG50-S40-4D	50	200	310	240					£118.00

SPMG DRILLING INSERTS

For Steels & Stainless Steel



Part Number	Description	Price
OM23968	SPMG 050204 OP3040	£4.20
OM23969	SPMG 060204 OP3040	£4.30
OM23970	SPMG 07T308 OP3040	£4.50
OM23971	SPMG 090408 OP3040	£5.00
OM23972	SPMG 110408 OP3040	£6.30
OM23973	SPMG 140512 OP3040	£7.80

SPGG DRILLING INSERTS

For Aluminium & Non-Ferrous Materials



Part Number	Description	Price
OM23974	SPGG 050204 AL K10	£6.20
OM23975	SPGG 060204 AL K10	£6.20
OM23976	SPGG 07T308 AL K10	£7.00
OM23977	SPGG 090408 AL K10	£7.30
OM23978	SPGG 110408 AL K10	£8.10
OM23979	SPGG 140512 AL K10	£9.20

Spare Screws

Part Number	Description	Price
OM23980	M2.0x5 Screw for SPMG 05	£3.80
OM23981	M2.2x5.5 Screw for SPMG 06	£3.80
OM23982	M2.5x8 Screw for SPMG 07	£3.80
OM23983	M3.5x9 Screw for SPMG 09	£3.80
OM23984	M4x10 Screw for SPMG 11	£3.80
OM23985	M5.0x11 Screw for SPMG 14	£4.20

Cutting Data for SPMG Drills

Material	Speed (m/min)	Feed (mm/rev)								
		Ø12.5-Ø15	Ø15.5-Ø21.5	Ø22-Ø27.5	Ø28-Ø33	Ø34-Ø41	Ø42-Ø50	Ø50-Ø60	Ø60-Ø75	Ø75-Ø80
Unalloyed steel	180-250	0.05-0.08	0.06-0.10	0.06-0.12	0.07-0.13	0.08-0.15	0.08-0.16	0.06-0.12	0.08-0.12	0.08-0.12
Low alloy steel	160-220	0.06-0.12	0.08-0.15	0.10-0.18	0.12-0.22	0.12-0.24	0.13-0.25	0.10-0.14	0.12-0.18	0.11-0.18
Low alloy steel	150-220	0.06-0.12	0.08-0.14	0.10-0.18	0.12-0.22	0.12-0.23	0.13-0.24	0.08-0.15	0.10-0.18	0.10-0.18
High alloy steel	130-180	0.06-0.10	0.08-0.15	0.10-0.20	0.12-0.23	0.12-0.24	0.13-0.25	0.08-0.14	0.09-0.15	0.09-0.14
Stainless steel	170-240	0.05-0.10	0.06-0.12	0.08-0.15	0.09-0.16	0.10-0.17	0.11-0.19	0.06-0.13	0.08-0.15	0.08-0.14
Grey Cast iron	180-250	0.06-0.12	0.08-0.16	0.12-0.20	0.15-0.25	0.16-0.28	0.18-0.30	0.12-0.20	0.15-0.20	0.15-0.20
Cast Iron Nodular	130-200	0.06-0.10	0.08-0.15	0.10-0.18	0.12-0.20	0.15-0.23	0.16-0.25	0.10-0.15	0.09-0.18	0.10-0.18
Aluminium forging alloys	330-380	0.06-0.14	0.08-0.15	0.10-0.20	0.12-0.22	0.14-0.23	0.15-0.26	0.14-0.20	0.14-0.23	0.15-0.23
Super-alloys and titanium	30-60	0.05-0.10	0.06-0.14	0.08-0.18	0.10-0.22	0.12-0.22	0.14-0.24	0.10-0.15	0.1-0.15	0.1-0.15

CENTRE & CHAMFER DRILL WITH 6 INSERTS

One tool for multiple applications

- Set includes:
- 1x CMN-1411100-S16 Holder Centre and Chamfer Drill 16x100
- 6x XDBP11T308-P Inserts CC Drill Insert for Alloy Steel



Part Number	Description	Insert	Price
OM14308	Centre & Chamfer Drill with 6 inserts	XDBP 11T3..	£99.00

CENTRE & CHAMFER DRILL HOLDERS

One tool for multiple applications

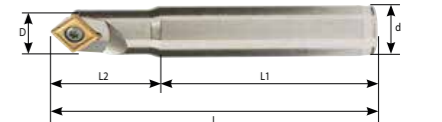

Part Number	Description	Dimensions (mm)					Insert	Price £
		D	d	L	L1	L2		
OM14301	CMN-1411100-S12	14	12	100	67	33	XDBP 11T3...	£40.00
OM14302	CMN-1411100-S16	14	16	100	67	33		£40.00
OM14303	CMN-1411150-S16	14	16	150	117	33		£58.00
OM14304	CMN-1411220-S16	14	16	220	187	33		£62.00

CHAMFER & CENTRE DRILL INSERTS

4 cutting edges per insert

- Maximum recommended cutting depth for centering & chamfering is 7mm

Part Number	Description	Corner Radius (mm)	Application	Price
OM14334	XDBP11T303-P	0.3	Alloy Steel	£16.80
OM14305	XDBP11T308-P	0.8		£16.80
OM14335	XDBP11T303-S	0.3	Stainless Steel	£16.80
OM14306	XDBP11T308-S	0.8		£16.80
OM14337	XDBP11T304-N	0.4	Non Ferrous	£16.80
OM14333	XDBP11T308-N	0.8		£16.80
OM14336	XDBP11T303-C	0.3	Cast Iron	£16.80
OM14307	XDBP11T308-C	0.8		£16.80

Spares

Part Number	Insert Screw	Price
OM14311	TSB-3508	£4.50

Cutting Data

Material	Cutting Speed m/min	Feed per rev. mm/rev
Carbon Steel	120-150	0.05
Alloy Steel	100-120	0.04
High Alloy Steel	60-80	0.03
Hard Steel HRC40°	60-80	0.03
Hard Steel HRC40° < HRC < 48°	50-60	0.03
Stainless Steel	50-60	0.03
Cast Iron	80-102	0.05

ISO CARBIDE TURNING INSERTS For Aluminium & Non-Ferrous

Positive Inserts
Uncoated

Part Number	Description	Price
OM15012	CCGT 060202 AL K10	£3.65
OM15014	CCGT 060204 AL K10	£3.65
OM15016	CCGT 09T302 AL K10	£4.05
OM15018	CCGT 09T304 AL K10	£4.05
OM15020	CCGT 09T308 AL K10	£4.05
OM15022	CCGT 120402 AL K10	£5.00
OM15024	CCGT 120404 AL K10	£5.00
OM15026	CCGT 120408 AL K10	£5.00
OM15028	DCGT 070202 AL K10	£3.40
OM15030	DCGT 070204 AL K10	£3.40
OM15032	DCGT 11T302 AL K10	£4.15
OM15034	DCGT 11T304 AL K10	£4.15
OM15036	DCGT 11T308 AL K10	£4.15
OM15038	RCGT 0803MO AL K10	£4.15
OM15040	RCGT 1003MO AL K10	£5.10
OM15042	SCGT 09T308 AL K10	£4.15
OM15044	SCGT 120404 AL K10	£5.00
OM15046	SCGT 120408 AL K10	£5.00
OM15048	TCGT 090204 AL K10	£3.85
OM15050	TCGT 110204 AL K10	£3.95
OM15052	TCGT 16T304 AL K10	£5.10
OM15054	TCGT 16T308 AL K10	£5.10
OM15056	VCGT 110302 AL K10	£4.95
OM15058	VCGT 110304 AL K10	£4.95
OM15060	VCGT 160404 AL K10	£6.25
OM15062	VCGT 160408 AL K10	£6.25
OM15064	VCGT 160412 AL K10	£6.25

Tin Coated

Part Number	Description	Price
OM15013	CCGT 060202 AL TIN	£4.60
OM15015	CCGT 060204 AL TIN	£4.60
OM15017	CCGT 09T302 AL TIN	£5.00
OM15019	CCGT 09T304 AL TIN	£5.00
OM15021	CCGT 09T308 AL TIN	£5.00
OM15023	CCGT 120402 AL TIN	£6.25
OM15025	CCGT 120404 AL TIN	£6.25
OM15027	CCGT 120408 AL TIN	£6.25
OM15029	DCGT 070202 AL TIN	£4.25
OM15031	DCGT 070204 AL TIN	£4.25
OM15033	DCGT 11T302 AL TIN	£5.30
OM15035	DCGT 11T304 AL TIN	£5.30
OM15037	DCGT 11T308 AL TIN	£5.30
OM15039	RCGT 0803MO AL TIN	£5.10
OM15041	RCGT 1003MO AL TIN	£6.15
OM15043	SCGT 09T308 AL TIN	£5.20
OM15045	SCGT 120404 AL TIN	£6.25
OM15047	SCGT 120408 AL TIN	£6.25
OM15049	TCGT 090204 AL TIN	£5.20
OM15051	TCGT 110204 AL TIN	£5.20
OM15053	TCGT 16T304 AL TIN	£6.25
OM15055	TCGT 16T308 AL TIN	£6.25
OM15057	VCGT 110302 AL TIN	£6.25
OM15059	VCGT 110304 AL TIN	£6.25
OM15061	VCGT 160404 AL TIN	£7.45
OM15063	VCGT 160408 AL TIN	£7.45
OM15065	VCGT 160412 AL TIN	£7.45



ISO CARBIDE TURNING INSERTS For Steel

Positive Inserts

Part Number	Description	Price
OM21000	CCMT 060202-FW BPS101	£2.78
OM21001	CCMT 060204-FW BPS101	£2.78
OM21002	CCMT 09T302-FW BPS101	£3.45
OM21003	CCMT 09T304-FW BPS101	£3.45
OM21004	CCMT 09T308-MD BPS251	£3.45
OM21005	CCMT 120404-MD BPS251	£4.75
OM21006	CCMT 120408-MD BPS251	£4.75
OM21007	DCMT 070202-FW BPS101	£3.10
OM21008	DCMT 070204-FW BPS101	£3.10
OM21009	DCMT 11T302-FW BPS101	£3.95
OM21010	DCMT 11T304-FW BPS101	£3.95
OM21011	DCMT 11T308-MD BPS251	£3.95
OM21094	TCMT 110204-MD BPS101	£3.25
OM21013	TCMT 16T304-FW BPS101	£3.95
OM21014	TCMT 16T308-MD BPS251	£3.95
OM21101	VBMT 110304-MD BPS101	£4.60
OM21016	VBMT 160404-FW BPS101	£6.10
OM21017	VBMT 160408-MD BPS251	£6.10
OM21095	VCMT 110304-MD BPS101	£4.60
OM21088	VCMT 160404-MD BPS101	£6.10
OM21020	VCMT 160408-MD BPS251	£6.10

Negative Inserts

Part Number	Description	Price
OM21021	CNMG 120404-FW BPS101	£4.10
OM21022	CNMG 120404-MA BPS251	£4.10
OM21023	CNMG 120408-MA BPS251	£4.10
OM21024	CNMG 120412-MA BPS251	£4.10
OM21089	DNMG 110404-MD BPS251	£3.45
OM21098	DNMG 110408-MD BPS251	£3.45
OM21027	DNMG 150604-MA BPS251	£6.58
OM21028	DNMG 150608-MA BPS251	£6.58
OM21099	SNMG 120408-MD BPS251	£4.10
OM21030	VNMG 160404-MA BPS251	£5.10
OM21031	VNMG 160408-MA BPS251	£5.10
OM21032	WNMG 060404-MD BPS251	£3.45
OM21033	WNMG 060408-MD BPS251	£3.45
OM21034	WNMG 080404-MA BPS251	£4.27
OM21035	WNMG 080408-MA BPS251	£4.27



Negative Inserts for Aluminium Uncoated

Part Number	Description	Price
OM21064	CNMG 120402-LH BU810	£3.85
OM21065	CNMG 120404-LH BU810	£3.85
OM21066	CNMG 120408-LH BU810	£3.85
OM21067	DNMG 150604-LH BU810	£4.60
OM21068	DNMG 150608-LH BU810	£4.60
OM21069	VNMG 160404-LH BU810	£4.80
OM21070	WNMG 060404-LH BU810	£3.80
OM21071	WNMG 080404-LH BU810	£4.00
OM21072	WNMG 080408-LH BU810	£4.00



ISO CARBIDE TURNING INSERTS For Stainless Steel



Positive Inserts

Part Number	Description	Price
OM21036	CCMT 060202-FW BPG20B	£3.60
OM21037	CCMT 060204-FW BPG20B	£3.60
OM21038	CCMT 060204-MD BPG20B	£3.60
OM21039	CCMT 09T302-FW BPG20B	£4.60
OM21040	CCMT 09T304-FW BPG20B	£4.60
OM21041	CCMT 09T304-MD BPG20B	£4.60
OM21042	DCMT 070202-FW BPG20B	£4.10
OM21043	DCMT 070204-FW BPG20B	£4.10
OM21044	DCMT 11T302-FW BPG20B	£5.45
OM21045	DCMT 11T304-FW BPG20B	£5.45
OM21046	DCMT 11T304-MD BPG20B	£5.45
OM21047	VCMT 110304-MD BPG20B	£5.45
OM21048	VCMT 160404-MD BPG20B	£8.10
OM21049	VCMT 160408-MD BPG20B	£8.10

Negative Inserts

Part Number	Description	Price
OM21050	CNMG 120404E-LH BPU10B	£5.10
OM21051	CNMG 120404-MA BPG20B	£5.10
OM21052	CNMG 120408E-LH BPG05B	£5.10
OM21053	CNMG 120408-MA BPG20B	£5.10
OM21054	DNMG 150604E-LH BPG05B	£7.10
OM21055	DNMG 150604-MA BPG20B	£7.10
OM21056	DNMG 150608E-LH BPG05B	£7.10
OM21057	DNMG 150608-MA BPG20B	£7.10
OM21058	SNMG 120408-MA BPG20B	£5.10
OM21059	VNMG 160404-MA BPG20B	£5.90
OM21060	WNMG 060404E-LH BPG05B	£4.00
OM21100	WNMG 060408-MD BPG20B	£4.00
OM21062	WNMG 080404E-LH BPG05B	£5.30
OM21063	WNMG 080408-MA BPG20B	£5.30

ISO CARBIDE TURNING INSERTS For Heat Resistant Alloys



Positive Inserts

Part Number	Description	Price
OM21073	CCGT 060202-SL BPG118	£7.90
OM21074	CCGT 060204-SL BPG118	£7.90
OM21075	CCGT 09T304-SL BPG118	£7.90
OM21076	DCGT 070202-SL BPG118	£6.80
OM21077	DCGT 070204-SL BPG118	£6.80
OM21078	DCGT 11T304-SL BPG118	£8.10
OM21079	VCGT 110304-SL BPG118	£8.20
OM21080	VCGT 160404-SL BPG118	£10.20

Negative Inserts

Part Number	Description	Price
OM21081	CNGG 120402E-LHC BPG118	£8.75
OM21082	CNGG 120404E-LHC BPG118	£8.75
OM21083	CNGG 120408E-LHC BPG118	£8.75
OM21084	DNGG 150604E-LHC BPG118	£10.20
OM21085	WNGG 060404E-LHC BPG118	£8.10
OM21086	WNGG 080404E-LHC BPG118	£8.40
OM21087	WNMG 080408E-LHC BPG118	£8.40

TECHNICAL INSERT INFORMATION

Aluminium	
Geometry	Application
AL	Positive ground edge inserts suitable for most applications on non-ferrous materials
LH	Negative inserts suitable for most applications on non-ferrous materials
Grade	Application
K10	Uncoated Sub-micron grade for continuous and interrupted machining of non-ferrous metals. ISO K10
TiN	Coated grade for enhanced tool life and cutting speeds on non-ferrous metals. Also can be utilized for finish machining of steel and stainless.
BU810	Uncoated Sub-micron grade for continuous and interrupted machining of non-ferrous metals. ISO K15
Steel	
Geometry	Application
FW	Finishing on most ferrous materials
MD	Positive geometry for wide range of medium turning on ferrous materials
MA	Universal geometry for most applications on ferrous materials
Grade	Application
BPS1 01	Black/yellow CVD coated grade. Good wear resistance suitable for continuous and light interrupted cutting. Mainly finishing applications. ISO P15/K15
BPS251	Black/yellow CVD coated grade. Universal grade for continuous and interrupted cutting. Wide application range. Can be used for Stainless steel. ISO P25/M20
Stainless	
Geometry	Application
FW	Finish turning geometry for most applications on stainless steel
LH	Sharp edge positive geometry for finishing stainless steel
MD	Medium machining geometry for stainless steel
MA	Universal geometry for medium/rough machining of stainless steel
Grade	Application
BPG05B	Dark blue/grey PVD coated grade. High speed cutting and finishing of stainless. ISO M10
BPG20B	Dark blue/grey PVD coated grade. Wide application for medium machining of stainless. ISO M25
Heat Resistant Alloys	
Geometry	Application
SL	High positive sharp ground edge geometry for finish machining of heat resistant and titanium alloys.
LHC	Sharp ground edge geometry for negative inserts. Low cutting forces on aerospace alloys.
Grade	Application
BPG118	Dark gold PVD coated grade for finish machining heat resistant alloys. Good resistance to built up edge and plastic deformation.

EXTERNAL THREADING INSERTS



Metric Full Form (60°) External

Part Number	Metric Full Form (60°) External	Price
OM15101	16ER 0.5 ISO	£6.95
OM15102	16ER 0.7 ISO	£6.95
OM15103	16ER 0.75 ISO	£6.95
OM15104	16ER 0.8 ISO	£6.95
OM15105	16ER 1.0 ISO	£6.95
OM15106	16ER 1.25 ISO	£6.95
OM15107	16ER 1.5 ISO	£6.95
OM15108	16ER 1.75 ISO	£6.95
OM15109	16ER 2.0 ISO	£6.95
OM15110	16ER 2.5 ISO	£6.95
OM15111	16ER 3.0 ISO	£6.95
OM15112	22ER 3.5 ISO	£10.95
OM15113	22ER 4.0 ISO	£10.95
OM15114	22ER 4.5 ISO	£10.95
OM15115	22ER 5.0 ISO	£10.95

UN Full Form (60°) External

Part Number	UN Full Form (60°) External	Price
OM15146	16ER 32 UN	£6.95
OM15147	16ER 28 UN	£6.95
OM15148	16ER 24 UN	£6.95
OM15149	16ER 20 UN	£6.95
OM15150	16ER 18 UN	£6.95
OM15151	16ER 16 UN	£6.95
OM15152	16ER 14 UN	£6.95
OM15153	16ER 12 UN	£6.95
OM15154	16ER 10 UN	£6.95
OM15155	16ER 8 UN	£6.95
OM15156	22ER 7 UN	£10.95
OM15157	22ER 6 UN	£10.95
OM15158	22ER 5 UN	£10.95

Whitworth/BSP Full Form (55°) External

Part Number	Whitworth/BSP Full Form (55°) External	Price
OM15176	16ER 28 W	£6.95
OM15177	16ER 24 W	£6.95
OM15178	16ER 20 W	£6.95
OM15179	16ER 19 W	£6.95
OM15180	16ER 14 W	£6.95
OM15181	16ER 11 W	£6.95
OM15182	16ER 8 W	£6.95
OM15183	22ER 7 W	£10.95
OM15184	22ER 6 W	£10.95
OM15185	22ER 5 W	£10.95

Partial Profile External (60°)

Part Number	Partial Profile External (60°)	Price
OM15195	16ER AG 60	£6.95
OM15196	16ER G 60	£6.95
OM15205	22ER AG 60 OP2130	£10.95

Partial Profile External (55°)

Part Number	Partial Profile External (55°)	Price
OM15197	16ER AG 55	£6.95
OM15198	16ER G 55	£6.95
OM15206	22ER AG 55 OP2130	£10.95



INTERNAL THREADING INSERTS



Metric Full Form (60°) Internal

Part Number	Metric Full Form (60°) Internal	Price
OM15116	11IR 0.5 ISO	£6.95
OM15117	11IR 0.7 ISO	£6.95
OM15118	11IR 0.75 ISO	£6.95
OM15119	11IR 0.8 ISO	£6.95
OM15120	11IR 1.0 ISO	£6.95
OM15121	11IR 1.25 ISO	£6.95
OM15122	11IR 1.5 ISO	£6.95
OM15123	11IR 1.75 ISO	£6.95
OM15124	11IR 2.0 ISO	£6.95
OM15125	16IR 0.5 ISO	£6.95
OM15126	16IR 0.7 ISO	£6.95
OM15127	16IR 0.75 ISO	£6.95
OM15128	16IR 0.8 ISO	£6.95
OM15129	16IR 1.0 ISO	£6.95
OM15130	16IR 1.25 ISO	£6.95
OM15131	16IR 1.5 ISO	£6.95
OM15132	16IR 1.75 ISO	£6.95
OM15133	16IR 2.0 ISO	£6.95
OM15134	16IR 2.5 ISO	£6.95
OM15135	16IR 3.0 ISO	£6.95
OM15136	22IR 3.5 ISO	£10.95
OM15137	22IR 4.0 ISO	£10.95
OM15138	22IR 4.5 ISO	£10.95
OM15139	22IR 5.0 ISO	£10.95

Whitworth/BSP Full Form (55°) Internal

Part Number	Whitworth/BSP Full Form (55°) Internal	Price
OM15171	11IR 28 W	£6.95
OM15172	11IR 24 W	£6.95
OM15173	11IR 20 W	£6.95
OM15174	11IR 19 W	£6.95
OM15175	11IR 14 W	£6.95
OM15186	16IR 24 W	£6.95
OM15187	16IR 20 W	£6.95
OM15188	16IR 19 W	£6.95
OM15189	16IR 14 W	£6.95
OM15190	16IR 11 W	£6.95
OM15191	16IR 8 W	£6.95
OM15192	22IR 7 W	£10.95
OM15193	22IR 6 W	£10.95
OM15194	22IR 5 W	£10.95

UN Full Form (60°) Internal

Part Number	UN Full Form (60°) Internal	Price
OM15140	11IR 28 UN	£6.95
OM15141	11IR 24 UN	£6.95
OM15142	11IR 20 UN	£6.95
OM15143	11IR 18 UN	£6.95
OM15144	11IR 16 UN	£6.95
OM15145	11IR 14 UN	£6.95
OM15159	16IR 28 UN	£6.95
OM15160	16IR 24 UN	£6.95
OM15161	16IR 20 UN	£6.95
OM15162	16IR 18 UN	£6.95
OM15163	16IR 16 UN	£6.95
OM15164	16IR 14 UN	£6.95
OM15165	16IR 12 UN	£6.95
OM15166	16IR 10 UN	£6.95
OM15167	16IR 8 UN	£6.95
OM15168	22IR 7 UN	£10.95
OM15169	22IR 6 UN	£10.95
OM15170	22IR 5 UN	£10.95

Partial Profile Internal (60°)

Part Number	Partial Profile Internal (60°)	Price
OM15199	11IR A 60	£6.95
OM15200	16IR AG 60	£6.95
OM15201	16IR G 60	£6.95

Partial Profile Internal (55°)

Part Number	Partial Profile Internal (55°)	Price
OM15202	11IR A 55	£6.95
OM15203	16IR AG 55	£6.95
OM15204	16IR G 55	£6.95

BT MAS403

BT MAS403 (JIS 6399) TECHNICAL SPECIFICATION

- Manufactured with Casehardening Steel
- Surface Hardened HRC 60+2
- Hardening Depth 0.8mm+0.2mm
- Taper Angle Tolerance AT3

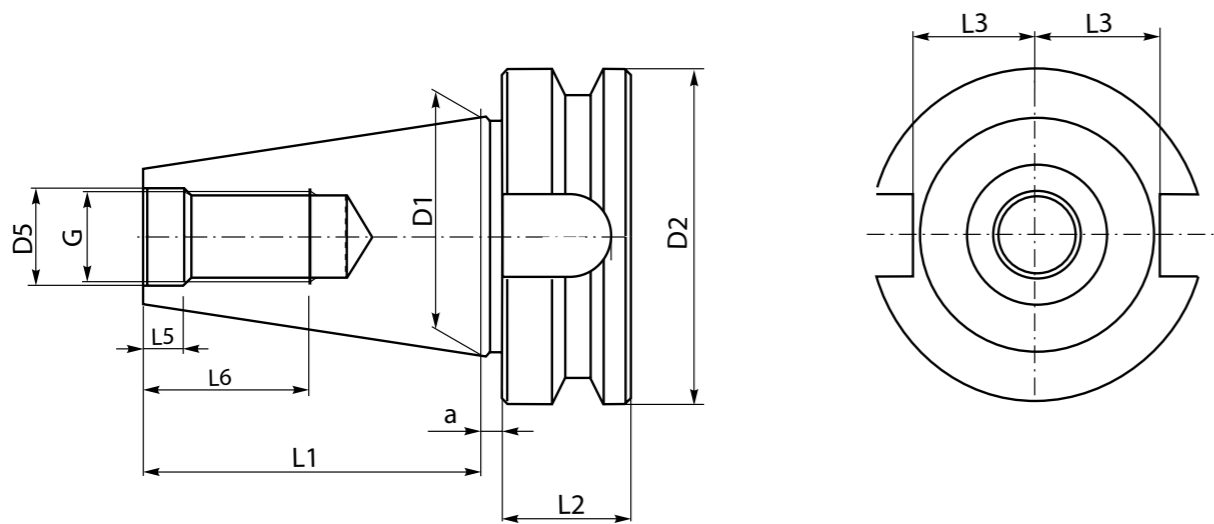

Taper	D1	G	D5	D2	a	L1	L2	L3	L5	L6
30	31.75	M12	12.5	46	2	48.4	22	16.3	7.0	24
40	44.45	M16	17.0	63	2	65.4	27	22.5	8.2	32
50	69.85	M24	25.0	100	3	101.8	38	35.3	11.0	47

Form AD

Through Spindle Coolant



Form AD/B

Through Spindle Coolant &
Through Flange Coolant

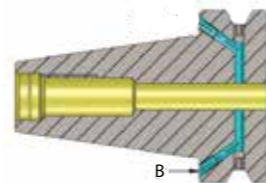

ER MINI NUT COLLET CHUCKS BT30 & BT40

- BT MAS403 (JIS 6339)
- MINI Nut ER Collet Chucks
- Slimline Extended Mini Chucks
- ER Collets – Pg. 154
- Spares – Pg. 214

Part Number	Description	Gauge Length (mm)	Form	Nut	Balance	Price
OM30283	BT30 ER11 MINI	70	AD	ER11 Mini (OM31414)	G2.5 @20,000 RPM	£39.00
OM30284		100	AD		G2.5 @20,000 RPM	£43.00
OM31971	BT30 ER16 MINI	60	AD	ER16 Mini (OM31415)	G2.5 @20,000 RPM	£39.00
OM30366		100	AD		G2.5 @20,000 RPM	£43.00
OM30367		150	AD		G2.5 @20,000 RPM	£71.00

OM31334	BT40 ER11 MINI	70	AD	ER11 Mini (OM31414)	G2.5 @20,000 RPM	£37.00
OM31636		70	AD/B		G2.5 @25,000 RPM	£44.00
OM31335		100	AD		G2.5 @20,000 RPM	£37.00
OM31637		100	AD/B		G2.5 @25,000 RPM	£44.00
OM31638		160	AD/B		G2.5 @25,000 RPM	£71.00
OM30298	BT40 ER16 MINI	70	AD	ER16 Mini (OM31415)	G2.5 @20,000 RPM	£37.00
OM31639		70	AD/B		G2.5 @25,000 RPM	£44.00
OM31336		100	AD		G2.5 @20,000 RPM	£37.00
OM31640		100	AD/B		G2.5 @25,000 RPM	£44.00
OM31641		160	AD/B		G2.5 @25,000 RPM	£71.00
OM30287		200	AD		G2.5 @20,000 RPM	£89.00



BT
(MAS403)

SHORT ER COLLET CHUCK BT40

- BT MAS403 (JIS 6339)
- Very Short for maximum rigidity
- ER Collets – Pg. 154
- Spares – Pg. 214

Part Number	Description	Collet Type	Gauge Length (mm)	Form	Balance	Price
OM31538	BT40 N ER32 SHORT	ER32	35	AD	G2.5 @25,000 RPM	£52.00



ER COLLET CHUCKS BT40

- BT MAS403 (JIS 6339)
- Standard Nut Collet Chucks
- ER Collet System
- Wide range of gauge lengths available
- ER Collets – Pg. 154
- Spares – Pg. 214

Part Number	Description	Gauge Length (mm)	Form	Nut	Balance	Price
OM31042	BT40 ER16	70	AD	ER16 Hexagon (OM31426)	G2.5 @20,000 RPM	£24.00
OM31642		70	AD/B		G2.5 @25,000 RPM	£34.00
OM31038		100	AD		G2.5 @20,000 RPM	£27.00
OM31643		100	AD/B		G2.5 @25,000 RPM	£37.00
OM31535		120	AD/B		G2.5 @25,000 RPM	£44.00
OM31039		150	AD		G2.5 @20,000 RPM	£47.00
OM31040		160	AD		G2.5 @20,000 RPM	£47.00
OM31644		160	AD/B		G2.5 @25,000 RPM	£56.00
OM31342		200	AD		G2.5 @20,000 RPM	£67.00
OM31645		200	AD/B		G2.5 @25,000 RPM	£83.00
OM31045	BT40 ER20	70	AD	ER20 Castellated (OM31420)	G2.5 @20,000 RPM	£24.00
OM31043		100	AD		G2.5 @20,000 RPM	£27.00
OM31954		120	AD		G2.5 @20,000 RPM	£41.00
OM31044		150	AD	G2.5 @20,000 RPM	£47.00	
OM31050	BT40 ER25	70	AD	ER25 Castellated (OM31421)	G2.5 @20,000 RPM	£24.00
OM34005		70	AD/B		G2.5 @25,000 RPM	£34.00
OM31046		100	AD		G2.5 @20,000 RPM	£27.00
OM31646		100	AD/B		G2.5 @25,000 RPM	£35.00
OM34007		120	AD		G2.5 @20,000 RPM	£39.00
OM31047		150	AD		G2.5 @20,000 RPM	£47.00
OM31048		160	AD		G2.5 @20,000 RPM	£47.00
OM31647		160	AD/B		G2.5 @25,000 RPM	£56.00
OM31343		200	AD		G2.5 @20,000 RPM	£67.00
OM31648		200	AD/B		G2.5 @25,000 RPM	£83.00
OM31056	BT40 ER32	70	AD	ER32 Castellated (OM31422)	G2.5 @20,000 RPM	£24.00
OM34004		70	AD/B		G2.5 @25,000 RPM	£34.00
OM31051		100	AD		G2.5 @20,000 RPM	£27.00
OM31536		100	AD/B		G2.5 @25,000 RPM	£36.00
OM31052		120	AD		G2.5 @20,000 RPM	£39.00
OM34006		120	AD/B		G2.5 @25,000 RPM	£42.00
OM31053		150	AD		G2.5 @20,000 RPM	£47.00
OM31054		160	AD		G2.5 @20,000 RPM	£47.00
OM31537		160	AD/B		G2.5 @25,000 RPM	£56.00
OM31344		200	AD		G6.3 @15,000 RPM	£67.00
OM31345	250	AD	G6.3 @15,000 RPM	£93.00		
OM31346	300	AD	G6.3 @15,000 RPM	£104.00		
OM31059	BT40 ER40	80	AD	ER40 Castellated (OM31423)	G2.5 @20,000 RPM	£24.00
OM31649		80	AD/B		G2.5 @25,000 RPM	£34.00
OM31057		100	AD		G2.5 @20,000 RPM	£27.00
OM31650		100	AD/B		G2.5 @25,000 RPM	£37.00
OM31058		150	AD		G6.3 @15,000 RPM	£47.00
OM31952		160	AD/B		G2.5 @25,000 RPM	£56.00
OM31060	BT40 ER50	100	AD	ER50 Castellated (OM31424)	G2.5 @20,000 RPM	£62.00



ER COLLET CHUCKS BT30

- BT MAS403 (JIS 6339)
- Standard Nut Collet Chucks
- ER Collet System
- ER Collets – Pg. 154
- Spares – Pg. 214

Part Number	Description	Gauge Length (mm)	Form	Nut	Balance	Price
OM31005	BT30 ER16	70	AD	ER16 Hexagon (OM31426)	G2.5 @25,000 RPM	£26.00
OM31560		100	AD		G2.5 @25,000 RPM	£33.00
OM31006	BT30 ER25	70	AD	ER25 Castellated (OM31421)	G2.5 @25,000 RPM	£26.00
OM31561		100	AD		G2.5 @25,000 RPM	£33.00
OM31007	BT30 ER32	70	AD	ER32 Castellated (OM31422)	G2.5 @25,000 RPM	£26.00
OM31562		100	AD		G2.5 @25,000 RPM	£33.00
OM31008	BT30 ER40	80	AD	ER40 Castellated (OM31423)	G2.5 @25,000 RPM	£26.00



ER COLLET CHUCKS BT50

- BT MAS403 (JIS 6339)
- Standard Nut Collet Chucks
- ER Collet System
- Wide range of gauge lengths available
- ER Collets – Pg. 154
- Spares – Pg. 214

Part Number	Description	Gauge Length (mm)	Form	Nut	Balance	Price
OM31115	BT50 ER16	70	AD	ER16 Hexagon (OM31426)	G6.3 @15,000 RPM	£50.00
OM31777		80	AD/B		G2.5 @25,000 RPM	£60.00
OM31347		100	AD		G6.3 @15,000 RPM	£60.00
OM31778		100	AD/B		G2.5 @25,000 RPM	£70.00
OM31779		160	AD/B		G2.5 @25,000 RPM	£88.00
OM31780		200	AD/B	G2.5 @25,000 RPM	£138.00	
OM31121	BT50 ER25	80	AD	ER25 Castellated (OM31421)	G6.3 @15,000 RPM	£50.00
OM31781		80	AD/B		G2.5 @25,000 RPM	£60.00
OM31116		100	AD		G6.3 @15,000 RPM	£61.00
OM31782		100	AD/B		G2.5 @25,000 RPM	£70.00
OM31119		160	AD		G6.3 @15,000 RPM	£78.00
OM31783		160	AD/B		G2.5 @25,000 RPM	£88.00
OM31784		200	AD/B		G2.5 @25,000 RPM	£138.00
OM31785		250	AD/B		G2.5 @25,000 RPM	£156.00
OM31127	BT50 ER32	70	AD	ER32 Castellated (OM31422)	G6.3 @15,000 RPM	£50.00
OM31128		80	AD		G6.3 @15,000 RPM	£50.00
OM31786		80	AD/B		G2.5 @25,000 RPM	£60.00
OM31122		100	AD		G6.3 @15,000 RPM	£61.00
OM31787		100	AD/B		G2.5 @25,000 RPM	£70.00
OM31123		150	AD		G6.3 @15,000 RPM	£76.00
OM31124		160	AD		G6.3 @15,000 RPM	£78.00
OM31788		160	AD/B		G2.5 @25,000 RPM	£88.00
OM31125		200	AD		G6.3 @15,000 RPM	£125.00
OM31789		200	AD/B		G2.5 @25,000 RPM	£138.00
OM31126		250	AD		G6.3 @15,000 RPM	£149.00
OM31790		250	AD/B		G2.5 @25,000 RPM	£173.00
OM31132	BT50 ER40	80	AD	ER40 Castellated (OM31423)	G6.3 @15,000 RPM	£50.00
OM31791		80	AD/B		G2.5 @25,000 RPM	£60.00
OM31348		100	AD		G6.3 @15,000 RPM	£60.00
OM31792		100	AD/B		G2.5 @25,000 RPM	£70.00
OM31130		160	AD		G6.3 @15,000 RPM	£78.00
OM31793		160	AD/B		G2.5 @25,000 RPM	£88.00
OM31794		200	AD/B		G2.5 @25,000 RPM	£138.00
OM31133	BT50 ER50	100	AD	ER50 Castellated (OM31424)	G6.3 @15,000 RPM	£83.00
OM31795		100	AD/B		G2.5 @25,000 RPM	£93.00



OZ COLLET CHUCKS BT40

- BT MAS403 (JIS 6339)
- OZ Collet System (DIN6388)
- Balanced G6.3 @ 15,000 RPM
- OZ Collets - Pg. 180
- Spares – Pg. 214

Part Number	Description	Gauge Length (mm)	Form	Price
OM31572	BT40 OZ 25 70	70	AD	£50.00
OM31573	BT40 OZ 32 80	80	AD	£59.00



DMC COLLET CHUCKS BT30, BT40 & BT50

- BT MAS403 (JIS 6339)
- Drawback Collet Style
- Ultra Precision DMC Slim Collet Chucks
- High Accuracy <0.005mm
- Balanced to G2.5 @ 25,000 RPM
- DMC Collets – Pg. 184
- Hex Keys – Pg. 217

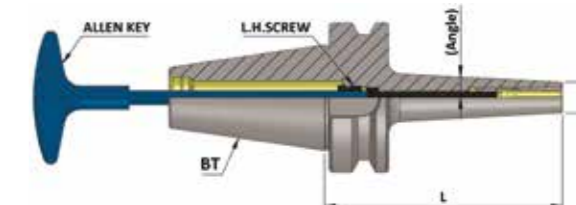

Part Number	Description	Dimensions (mm)			Angle	Collet	Screw	Allen Key	Price
		Clamping Range	D1	L					
OM32290	BT30 DMC 06	3-6	13	90	3°	DMC 06	M5	4X200	£79.00
OM32291	BT40 DMC 06	3-6	13	60	3°	DMC 06	M5	4X200	£79.00
OM32292		3-6	13	90	3°	DMC 06	M5	4X200	£79.00
OM32293		3-6	13	120	3°	DMC 06	M5	4X200	£89.00
OM32294		3-6	13	160	3°	DMC 06	M5	4X200	£94.00
OM32295	BT40 DMC 08	3-8	22	90	3°	DMC 08	M6	5X200	£79.00
OM32296		3-8	22	120	3°	DMC 08	M6	5X200	£89.00
OM32297	BT40 DMC 10	3-10	28	90	3°	DMC 10	M8	6X200	£79.00
OM32298		3-10	28	120	3°	DMC 10	M8	6X200	£89.00
OM32325	BT50 DMC 10	3-10	28	150	3°	DMC 10	M8	6X200	£119.00



BT
(MAS403)

BT
(MAS403)

GSK COLLET CHUCKS BT30 & BT40

- BT MAS403 (JIS 6339)
- High Accuracy GSK Collet Chucks
- Excellent for use in high speed cutting and precise milling
- Balanced to G2.5 @ 25,000 RPM
- GSK Collets – Pg. 182
- Spares – Pg. 214

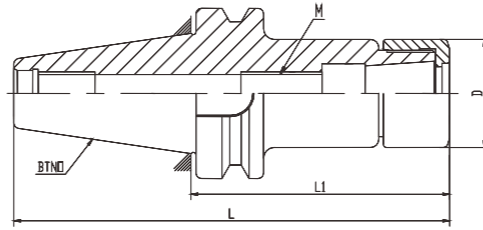

Part Number	Description	Dimensions (mm)			Price
		Gauge Length L1	D	M	
OM30400	BT30 GSK 06	60	19.5	M8 x 1	£67.00
OM30401		90			£67.00
OM30402		120			£78.00
OM30403		150			£89.00
OM30404	BT30 GSK 10	60	27	M11 x 1	£67.00
OM30405		90			£67.00
OM30406	BT30 GSK 16	60	40	M18 x 1.5	£67.00
OM30407		90			£67.00
OM30408	BT30 GSK 25	75	55	M28 x 1.5	£67.00

OM30415	BT40 GSK 06	60	19.5	M8 x 1	£67.00
OM30409		90			£67.00
OM30475		120			£78.00
OM30410		150			£89.00
OM30411	BT40 GSK 10	60	27	M11 x 1	£67.00
OM30412		90			£67.00
OM30413		120			£78.00
OM30414	BT40 GSK 16	150	40	M18 x 1.5	£89.00
OM30416		60			£67.00
OM30417		90			£67.00
OM30418		120			£78.00
OM30419		150			£89.00
OM30420	BT40 GSK 25	200	55	M28 x 1.5	£109.00
OM30421		90			£78.00
OM30422		120			£96.00
OM30423		150			£102.00

HYDRAULIC EXPANSION CHUCKS BT30, BT40 & BT50

- BT MAS403 (JIS 6339)
- Ultra Precision Hydraulic Chucks
- High Accuracy <0.005mm
- Balanced to G2.5 @ 25,000 RPM
- Spares – Pg. 214

Figure 1

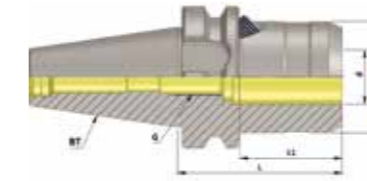
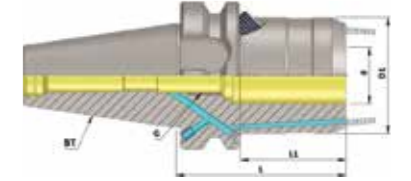

Figure 2



Part Number	Description	Dimensions (mm)					Form	Fig.	Price
		d	D1	G	L	L1			
OM32103	BT30 HC12S	12	42	M10	69	40	AD	Fig. 1	£138.00
OM32149		12	42	M10	69	40	AD/B + Cool	Fig. 2	£158.00
OM32104	BT30 HC20S	20	50	M16	90	42	AD	Fig. 1	£138.00
OM32150		20	50	M16	90	42	AD/B + Cool	Fig. 2	£158.00

OM32105	BT40 HC12S	12	42	M10	58	40	AD	Fig. 1	£138.00
OM32151		12	42	M10	58	40	AD/B + Cool	Fig. 2	£178.00
OM32106	BT40 HC20S	20	50	M16	72.5	42	AD	Fig. 1	£138.00
OM32152		20	50	M16	72.5	42	AD/B + Cool	Fig. 2	£178.00

OM32107	BT50 HC12S	12	42	M10	69	40	AD	Fig. 1	£186.00
OM32153		12	42	M10	69	40	AD/B + Cool	Fig. 2	£198.00
OM32108	BT50 HC20S	20	50	M16	83	42	AD	Fig. 1	£186.00
OM32154		20	50	M16	83	42	AD/B + Cool	Fig. 2	£198.00
OM32109	BT50 HC32S	32	72	M16	90	55	AD	Fig. 1	£192.00
OM32155		32	72	M16	90	55	AD/B + Cool	Fig. 2	£208.00



Hydraulic Chuck Kit

Part Number	Description	Price
OM36183	BT40 HC20 Kit BT40 20mm Chuck + 5 Collets: 6, 8, 10, 12, & 16mm Collets	£365.00



BT
(MAS403)

BT
(MAS403)

PREMIUM POWER MILLING CHUCKS BT40 & BT50

- BT MAS403 (JIS 6339)
- High Accuracy <0.005mm
- Power Milling Chucks are subjected to sub-zero treatment (-90° C). This helps prevent any deformation, increasing tool life
- Balanced G6.3 @ 15,000 RPM
- Straight Collets – Pg. 185
- Spares – Pg. 214

Part Number	Description	Dimensions (mm)				Price
		d	D1	L	L1	
OM30797	BT40 UPMC 20	20	54	80	70	£154.00
OM30798	BT40 UPMC 32	32	72	90	100	£164.00
OM30799	BT50 UPMC 20	20	54	105	70	£186.00
OM30915	BT50 UPMC 32	32	72	105	100	£219.00

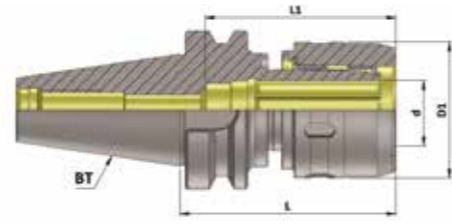

SHRINK FIT CHUCKS BT40

- BT MAS403 (JIS 6339)
- Superior Clamping Strength & Rigidity
- Form AD/B
- 4.5 Degree
- Balanced G2.5 @ 25,000 RPM

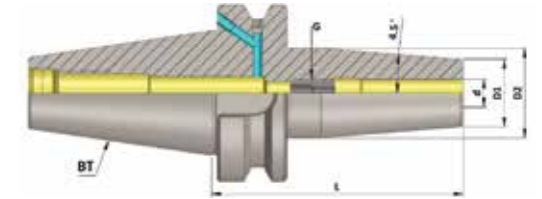

Part Number	Description	Dimensions (mm)					Price
		d	D1	D2	G	L	
OM30871	BT40 SF03	3mm	10	20	-	90	£92.00
OM30872			10	20	-	120	£119.00
OM30873			10	20	-	160	£145.00
OM30800	BT40 SF04	4mm	15	22	-	90	£92.00
OM30874			15	22	-	120	£119.00
OM30875			15	22	-	160	£145.00
OM30876	BT40 SF05	5mm	15	22	-	90	£92.00
OM30877			15	22	-	120	£119.00
OM30878			15	22	-	160	£145.00
OM30801	BT40 SF06	6mm	21	27	M5	90	£72.00
OM30802			21	27	M5	120	£92.00
OM30803			21	27	M5	160	£119.00
OM34291			21	27	M5	200	£165.00
OM30804	BT40 SF08	8mm	21	27	M6	90	£72.00
OM30805			21	27	M6	120	£92.00
OM30806			21	27	M6	160	£119.00
OM34292			21	27	M6	200	£165.00
OM30807	BT40 SF10	10mm	24	31	M8	90	£72.00
OM30808			24	31	M8	120	£92.00
OM30809			24	31	M8	160	£119.00
OM34293			24	31	M8	200	£165.00
OM30810	BT40 SF12	12mm	24	31	M10	90	£72.00
OM30811			24	31	M10	120	£92.00
OM30812			24	31	M10	160	£119.00
OM34294			24	31	M10	200	£165.00
OM30879	BT40 SF14	14mm	27	34	M10	90	£72.00
OM30880			27	34	M10	120	£92.00
OM30881			27	34	M10	160	£119.00
OM30813			27	34	M12	90	£72.00
OM30814	BT40 SF16	16mm	27	34	M12	120	£92.00
OM30815			27	34	M12	160	£119.00
OM34296			27	34	M12	200	£165.00
OM30882	BT40 SF18	18mm	33	40	M12	90	£72.00
OM30883			33	40	M12	120	£92.00
OM30884			33	40	M12	160	£119.00
OM30816	BT40 SF20	20mm	33	40	M16	90	£72.00
OM30817			33	40	M16	120	£92.00
OM30818			33	40	M16	160	£119.00
OM34298			33	40	M16	200	£165.00
OM30819	BT40 SF25	25mm	44	53	M16	100	£72.00
OM30820			44	53	M16	120	£92.00
OM30821			44	53	M16	160	£119.00
OM30822			44	53	M16	100	£72.00
OM30885	BT40 SF32	32mm	44	53	M16	120	£92.00
OM30823			44	53	M16	160	£119.00



STANDARD POWER MILLING CHUCKS BT40 & BT50

- BT MAS403 (JIS 6339)
- Balanced G6.3 @ 12,000 RPM
- Economy chuck for general engineering applications
- Straight Collets – Pg. 184
- Spares – Pg. 214

Part Number	Description	Clamping Size (mm)	Gauge Length (mm)	Price
OM31077	BT40 SC20	20	80	£104.00
OM31349	BT40 SC25	25	100	£104.00
OM31350	BT40 SC32	32	105	£104.00
OM31632	BT50 SC25	25	110	£132.00
OM31633	BT50 SC32	32	115	£132.00



BT
(MAS403)

BT
(MAS403)

MILLING CUTTER ARBORS BT40 & BT50

- BT MAS403 (JIS 6339)
- Arbors for Screw Type Modular Milling Cutters
- Balanced to G2.5 @ 25,000RPM
- Form AD/B

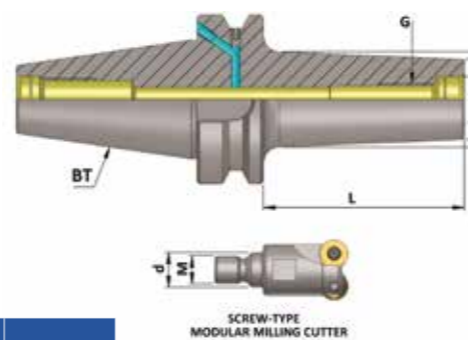

Part Number	Description	Dimensions (mm)					Price
		d	D1	D2	G	L	
OM30916	BT40 MCA 06	6.5	10	13	M6	25	£62.00
OM30917		6.5	10	20		50	£72.00
OM30918		6.5	10	23		75	£78.00
OM30919	BT40 MCA 08	8.5	13	15	M8	25	£62.00
OM30920		8.5	13	23		50	£72.00
OM30921		8.5	13	23		75	£78.00
OM30922	BT40 MCA 10	8.5	13	25	M10	100	£88.00
OM30923		10.5	18	20		25	£62.00
OM30924		10.5	18	23		50	£72.00
OM30925	BT40 MCA 12	10.5	18	28	M12	75	£78.00
OM30926		10.5	18	32		100	£88.00
OM30927		12.5	21	24		25	£62.00
OM30928	BT40 MCA 16	12.5	21	24	M16	50	£72.00
OM30929		12.5	21	31		75	£78.00
OM30930		12.5	21	33		100	£88.00
OM30931	BT50 MCA 08	12.5	21	36	M16	125	£100.00
OM30932		17	29	29		25	£62.00
OM30933		17	29	34		50	£72.00
OM30934	BT50 MCA 10	17	29	34	M10	75	£78.00
OM30935		17	29	36		100	£88.00
OM30936		17	29	40		125	£100.00
OM30937	BT50 MCA 12	17	29	42.5	M12	150	£110.00
OM30938		8.5	13	23		50	£88.00
OM30939		8.5	13	25		100	£109.00
OM30940	BT50 MCA 16	8.5	13	30	M16	150	£120.00
OM30941		10.5	18	23		50	£88.00
OM30942		10.5	18	32		100	£109.00
OM30943	BT50 MCA 12	10.5	18	36.5	M12	150	£120.00
OM30944		12.5	21	24		50	£88.00
OM30945		12.5	21	33		100	£109.00
OM30946	BT50 MCA 16	12.5	21	40	M16	150	£120.00
OM30947		17	29	34		50	£88.00
OM30948		17	29	36		100	£109.00
OM30949	BT50 MCA 20	17	29	42.5	M20	150	£120.00
OM30950		17	29	42.5		150	£120.00



PARALLEL MILLING CUTTER ARBORS BT40

- BT MAS403 (JIS 6339)
- Cylindrical Arbors for Screw Type Modular Milling Cutters
- Balanced to G2.5 @ 25,000RPM
- Form AD/B

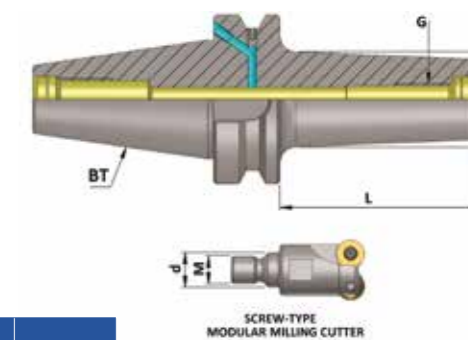

Part Number	Description	Dimensions (mm)					Price
		d	D1	D2	G	L	
OM34702	BT40 MCAP 08	8.5	13.8	13.8	M8	50	£79.00
OM34705	BT40 MCAP 10	10.5	18	18	M10	50	£79.00
OM34706		10.5	18	18		75	£86.00
OM34707	BT40 MCAP 12	10.5	18	18	M12	100	£98.00
OM34709		12.5	21	21		50	£79.00
OM34710		12.5	21	21		75	£86.00
OM34711	BT40 MCAP 16	12.5	21	21	M16	100	£98.00
OM34713		17	29	29		50	£79.00
OM34714		17	29	29		75	£86.00
OM34715	BT40 MCAP 20	17	29	29	M20	100	£98.00
OM34716		17	29	29		150	£120.00



BT
(MAS403)

BT
(MAS403)

END MILL HOLDERS BT30

- BT MAS403 (JIS 6339)
- For mounting straight shank tools with weldon flat
- Spare Clamp Screws – Pg. 218

Part Number	Description	Bore Size	Gauge Length (mm)	Form	Balance	Price
OM31017	BT30 S/L 06	6mm	50	AD	G2.5 @20,000 RPM	£32.00
OM31018	BT30 S/L 08	8mm	50	AD	G2.5 @20,000 RPM	£32.00
OM31019	BT30 S/L 10	10mm	50	AD	G2.5 @20,000 RPM	£32.00
OM31020	BT30 S/L 12	12mm	63	AD	G2.5 @20,000 RPM	£32.00
OM31021	BT30 S/L 16	16mm	63	AD	G2.5 @20,000 RPM	£32.00
OM31022	BT30 S/L 20	20mm	63	AD	G2.5 @20,000 RPM	£32.00



END MILL HOLDERS BT40

Part Number	Description	Bore Size	Gauge Length (mm)	Form	Balance	Price		
OM31084	BT40 S/L 12	12mm	63	AD	G2.5 @20,000 RPM	£24.00		
OM31663			63	AD/B	G2.5 @25,000 RPM	£34.00		
OM31085			100	AD	G2.5 @20,000 RPM	£29.00		
OM31664			100	AD/B	G2.5 @25,000 RPM	£39.00		
OM31665			160	AD/B	G2.5 @25,000 RPM	£51.00		
OM36203			200	AD	G6.3 @15,000 RPM	£98.00		
OM31553	BT40 S/L 14	14mm	63	AD	G2.5 @20,000 RPM	£29.00		
OM31559			100	AD	G2.5 @20,000 RPM	£32.00		
OM31351	BT40 S/L 16	16mm	35	AD	G2.5 @20,000 RPM	£37.00		
OM31086			63	AD	G2.5 @20,000 RPM	£24.00		
OM31539			63	AD/B	G2.5 @25,000 RPM	£32.00		
OM31087			100	AD	G2.5 @20,000 RPM	£29.00		
OM31667			100	AD/B	G2.5 @25,000 RPM	£39.00		
OM30197			160	AD	G2.5 @20,000 RPM	£46.00		
OM31668			160	AD/B	G2.5 @25,000 RPM	£54.00		
OM30198			200	AD	G2.5 @20,000 RPM	£98.00		
OM31088	BT40 S/L 18	18mm	63	AD	G2.5 @20,000 RPM	£29.00		
OM30199			100	AD	G2.5 @20,000 RPM	£32.00		
OM30254			160	AD	G2.5 @20,000 RPM	£49.00		
OM31352	BT40 S/L 20	20mm	35	AD	G2.5 @20,000 RPM	£37.00		
OM31090			63	AD	G2.5 @20,000 RPM	£24.00		
OM31541			63	AD/B	G2.5 @25,000 RPM	£32.00		
OM31089			100	AD	G2.5 @20,000 RPM	£29.00		
OM31670			100	AD/B	G2.5 @25,000 RPM	£39.00		
OM30255			160	AD	G2.5 @20,000 RPM	£46.00		
OM31671			160	AD/B	G2.5 @25,000 RPM	£54.00		
OM30256			200	AD	G2.5 @20,000 RPM	£98.00		
OM31353			BT40 S/L 25	25mm	35	AD	G2.5 @20,000 RPM	£36.00
OM31093					70	AD	G2.5 @20,000 RPM	£24.00
OM31673	70	AD/B			G2.5 @25,000 RPM	£34.00		
OM31094	90	AD			G2.5 @20,000 RPM	£24.00		
OM31549	100	AD			G2.5 @20,000 RPM	£24.00		
OM31674	100	AD/B			G2.5 @25,000 RPM	£39.00		
OM31675	160	AD/B			G2.5 @25,000 RPM	£54.00		
OM30781	200	AD			G2.5 @20,000 RPM	£98.00		
OM31354	BT40 S/L 32	32mm	65	AD	G2.5 @20,000 RPM	£37.00		
OM31095			100	AD	G2.5 @20,000 RPM	£24.00		
OM31677			100	AD/B	G2.5 @25,000 RPM	£39.00		
OM31678			160	AD/B	G2.5 @25,000 RPM	£59.00		
OM36204			200	AD	G6.3 @15,000 RPM	£115.00		
OM31096	BT40 S/L 40	40mm	120	AD	G2.5 @20,000 RPM	£36.00		



END MILL HOLDERS BT40

- BT MAS403 (JIS 6339)
- For mounting straight shank tools with weldon flat
- Wide range of gauge lengths available
- Spare Clamp Screws – Pg. 218

Part Number	Description	Bore Size	Gauge Length (mm)	Form	Balance	Price
OM31078	BT40 S/L 06	6mm	50	AD	G2.5 @20,000 RPM	£24.00
OM31651			50	AD/B	G2.5 @25,000 RPM	£34.00
OM31079			100	AD	G2.5 @20,000 RPM	£29.00
OM31652			100	AD/B	G2.5 @25,000 RPM	£39.00
OM31653			160	AD/B	G2.5 @25,000 RPM	£51.00
OM36200			200	AD	G6.3 @15,000 RPM	£98.00
OM31080	BT40 S/L 08	8mm	50	AD	G2.5 @20,000 RPM	£24.00
OM31655			50	AD/B	G2.5 @25,000 RPM	£34.00
OM31081			100	AD	G2.5 @20,000 RPM	£29.00
OM31656			100	AD/B	G2.5 @25,000 RPM	£39.00
OM31657			160	AD/B	G2.5 @25,000 RPM	£51.00
OM36201			200	AD	G6.3 @15,000 RPM	£98.00
OM31082	BT40 S/L 10	10mm	63	AD	G2.5 @20,000 RPM	£24.00
OM31659			63	AD/B	G2.5 @25,000 RPM	£34.00
OM31083			100	AD	G2.5 @20,000 RPM	£29.00
OM31660			100	AD/B	G2.5 @25,000 RPM	£39.00
OM31661			160	AD/B	G2.5 @25,000 RPM	£51.00
OM36202			200	AD	G6.3 @15,000 RPM	£98.00



END MILL HOLDERS BT50

- BT MAS403 (JIS 6339)
- For mounting straight shank tools with weldon flat
- Wide range of gauge lengths available
- Spare Clamp Screws – Pg. 218

Part Number	Description	Bore Size	Gauge Length (mm)	Form	Balance	Price
OM31153	BT50 S/L 06	6mm	63	AD	G6.3 @15,000 RPM	£48.00
OM31796			63	AD/B	G2.5 @25,000 RPM	£51.00
OM31797			100	AD/B	G2.5 @25,000 RPM	£55.00
OM31798			160	AD/B	G2.5 @25,000 RPM	£83.00
OM31154	BT50 S/L 08	8mm	63	AD	G6.3 @15,000 RPM	£45.00
OM31800			63	AD/B	G2.5 @25,000 RPM	£51.00
OM31801			100	AD/B	G2.5 @25,000 RPM	£55.00
OM31802			160	AD/B	G2.5 @25,000 RPM	£83.00
OM31156	BT50 S/L 10	10mm	63	AD	G6.3 @15,000 RPM	£45.00
OM31804			63	AD/B	G2.5 @25,000 RPM	£51.00
OM31805			100	AD/B	G2.5 @25,000 RPM	£55.00
OM31806			160	AD/B	G2.5 @25,000 RPM	£83.00
OM31157	BT50 S/L 12	12mm	80	AD	G6.3 @15,000 RPM	£45.00
OM31808			80	AD/B	G2.5 @25,000 RPM	£51.00
OM31809			100	AD/B	G2.5 @25,000 RPM	£55.00
OM31810			160	AD/B	G2.5 @25,000 RPM	£83.00
OM36208			200	AD	G6.3 @15,000 RPM	£119.00
OM31159	BT50 S/L 16	16mm	80	AD	G6.3 @15,000 RPM	£45.00
OM31812			80	AD/B	G2.5 @25,000 RPM	£51.00
OM31813			100	AD/B	G2.5 @25,000 RPM	£55.00
OM31814			160	AD/B	G2.5 @25,000 RPM	£83.00
OM36209			200	AD	G6.3 @15,000 RPM	£119.00
OM31160	BT50 S/L 20	20mm	80	AD	G6.3 @15,000 RPM	£45.00
OM31816			80	AD/B	G2.5 @25,000 RPM	£51.00
OM31817			100	AD/B	G2.5 @25,000 RPM	£55.00
OM31818			160	AD/B	G2.5 @25,000 RPM	£83.00
OM36210			200	AD	G6.3 @15,000 RPM	£119.00
OM31162	BT50 S/L 25	25mm	100	AD	G6.3 @15,000 RPM	£45.00
OM31820			100	AD/B	G2.5 @25,000 RPM	£65.00
OM31821			160	AD/B	G2.5 @25,000 RPM	£83.00
OM36210			200	AD	G6.3 @15,000 RPM	£119.00
OM31164	BT50 S/L 32	32mm	100	AD	G6.3 @15,000 RPM	£45.00
OM31823			100	AD/B	G2.5 @25,000 RPM	£68.00
OM31824			160	AD/B	G2.5 @25,000 RPM	£83.00
OM36212			200	AD	G6.3 @15,000 RPM	£119.00
OM31167	BT50 S/L 40	40mm	110	AD	G6.3 @15,000 RPM	£51.00
OM31826			110	AD/B	G2.5 @25,000 RPM	£68.00
OM36213			160	AD	G6.3 @15,000 RPM	£98.00
OM30187	BT50 S/L 50	50mm	120	AD	G6.3 @15,000 RPM	£125.00



END MILL HOLDERS WITH COOLANT CHANNELS BT40

- BT MAS403 (JIS 6339)
- For mounting straight shank tools with weldon flat
- Spare Clamp Screws – Pg. 218

Part Number	Description	Bore Size (mm)	Gauge Length (mm)	Form	Balance	Price
OM30757	BT40 S/L 06 FCC	6	50	AD/B	G2.5@25000	£49.00
OM30758	BT40 S/L 08 FCC	8	50	AD/B	G2.5@25000	£49.00
OM30759	BT40 S/L 10 FCC	10	63	AD/B	G2.5@25000	£49.00
OM30760	BT40 S/L 12 FCC	12	63	AD/B	G2.5@25000	£49.00
OM30761	BT40 S/L 16 FCC	16	63	AD/B	G2.5@25000	£49.00
OM30762	BT40 S/L 20 FCC	20	63	AD/B	G2.5@25000	£49.00



STANDARD FACE MILL ARBORS BT30, BT40 & BT50

- BT MAS403 (JIS 6339)
- Non Through Coolant
- For Mounting Face Mill Cutters

Part Number	Description	Spigot Size	Gauge Length (mm)	Balance	Price
OM31979	BT30 FMB 16	16mm	40	G2.5 @20,000 RPM	£34.00
OM31009	BT30 FMB 22	22mm	40	G2.5 @20,000 RPM	£34.00
OM31011	BT30 FMB 27	27mm	45	G2.5 @20,000 RPM	£34.00
OM31012	BT30 FMB 32	32mm	45	G2.5 @20,000 RPM	£34.00

OM31063	BT40 FMB 16	16mm	45	G6.3 @15,000 RPM	£29.00
OM31062			100	G6.3 @15,000 RPM	£40.00
OM31355			160	G6.3 @15,000 RPM	£71.00
OM30193			200	G6.3 @15,000 RPM	£98.00
OM31065	BT40 FMB 22	22mm	45	G6.3 @15,000 RPM	£29.00
OM31064			100	G6.3 @15,000 RPM	£40.00
OM31356			160	G6.3 @15,000 RPM	£71.00
OM31634			200	G6.3 @15,000 RPM	£98.00
OM30194	BT40 FMB 22	22mm	250	G6.3 @15,000 RPM	£128.00
OM30195			300	G6.3 @15,000 RPM	£140.00
OM31067			45	G6.3 @15,000 RPM	£29.00
OM31066	BT40 FMB 27	27mm	100	G6.3 @15,000 RPM	£40.00
OM31357			160	G6.3 @15,000 RPM	£71.00
OM30783			200	G6.3 @15,000 RPM	£98.00
OM30784			250	G6.3 @15,000 RPM	£128.00
OM30196	BT40 FMB 27	27mm	300	G6.3 @15,000 RPM	£140.00
OM31068			BT40 FMB 32	32mm	45
OM31070	BT40 FMB 40	40mm	60	G6.3 @15,000 RPM	£38.00

OM33687	BT50 FMB 22	22mm	60	G6.3 @15,000 RPM	£49.00
OM31135			100	G6.3 @15,000 RPM	£61.00
OM31136			150	G6.3 @15,000 RPM	£87.00
OM31141	BT50 FMB 27	27mm	60	G6.3 @15,000 RPM	£49.00
OM31138			100	G6.3 @15,000 RPM	£61.00
OM31139			150	G6.3 @15,000 RPM	£87.00
OM31144	BT50 FMB 32	32mm	60	G6.3 @15,000 RPM	£49.00
OM31142			100	G6.3 @15,000 RPM	£61.00
OM31146	BT50 FMB 40	40mm	60	G6.3 @15,000 RPM	£52.00
OM31145			100	G6.3 @15,000 RPM	£61.00



THROUGH COOLANT FACE MILL ARBORS BT40 & BT50

- BT MAS403 (JIS 6339)
- For Mounting Face Mill Cutters
- Wide range of gauge lengths available
- AD/B + Cool Holders allow for coolant through flange and through centre

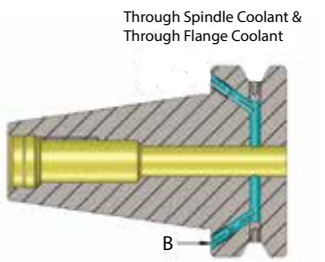

Part Number	Description	Spigot Size	Gauge Length (mm)	Form	Balance	Price		
OM31680	BT40 FMB 16	16mm	45	AD/B + Cool	G2.5 @25,000 RPM	£41.00		
OM31681			100	AD/B + Cool	G2.5 @25,000 RPM	£52.00		
OM31682			160	AD/B + Cool	G2.5 @25,000 RPM	£83.00		
OM31684	BT40 FMB 22	22mm	45	AD/B + Cool	G2.5 @25,000 RPM	£41.00		
OM31685			100	AD/B + Cool	G2.5 @25,000 RPM	£52.00		
OM31686			160	AD/B + Cool	G2.5 @25,000 RPM	£83.00		
OM31687	BT40 FMB 22	22mm	200	AD/B + Cool	G6.3 @15,000 RPM	£119.00		
OM31688			BT40 FMB 27	27mm	45	AD/B + Cool	G2.5 @25,000 RPM	£41.00
OM31689					100	AD/B + Cool	G2.5 @25,000 RPM	£52.00
OM31690	BT40 FMB 27	27mm	160	AD/B + Cool	G2.5 @25,000 RPM	£83.00		
OM31692			BT40 FMB 32	32mm	45	AD/B + Cool	G2.5 @25,000 RPM	£41.00
OM31693					100	AD/B + Cool	G2.5 @25,000 RPM	£52.00
OM31694	160	AD/B + Cool			G2.5 @25,000 RPM	£83.00		
OM31695	BT40 FMB 32	32mm	200	AD/B + Cool	G6.3 @15,000 RPM	£129.00		
OM31696			BT40 FMB 40	40mm	60	AD/B + Cool	G2.5 @25,000 RPM	£52.00
OM31697					100	AD/B + Cool	G2.5 @25,000 RPM	£55.00
OM31698	BT40 FMB 40	40mm	160	AD/B + Cool	G6.3 @15,000 RPM	£109.00		

OM31829	BT50 FMB 16	16mm	45	AD/B + Cool	G2.5 @25,000 RPM	£64.00
OM31830			100	AD/B + Cool	G2.5 @25,000 RPM	£72.00
OM31831			160	AD/B + Cool	G2.5 @25,000 RPM	£94.00
OM31832			200	AD/B + Cool	G2.5 @25,000 RPM	£125.00
OM31836	BT50 FMB 22	22mm	45	AD/B + Cool	G2.5 @25,000 RPM	£64.00
OM31837			100	AD/B + Cool	G2.5 @25,000 RPM	£72.00
OM31838			160	AD/B + Cool	G2.5 @25,000 RPM	£94.00
OM31839			200	AD/B + Cool	G2.5 @25,000 RPM	£125.00
OM31843	BT50 FMB 27	27mm	50	AD/B + Cool	G2.5 @25,000 RPM	£64.00
OM31844			100	AD/B + Cool	G2.5 @25,000 RPM	£72.00
OM31845			160	AD/B + Cool	G2.5 @25,000 RPM	£94.00
OM31846			200	AD/B + Cool	G2.5 @25,000 RPM	£125.00
OM31850	BT50 FMB 32	32mm	50	AD/B + Cool	G2.5 @25,000 RPM	£64.00
OM31851			100	AD/B + Cool	G2.5 @25,000 RPM	£72.00
OM31852			160	AD/B + Cool	G2.5 @25,000 RPM	£94.00
OM31853			200	AD/B + Cool	G6.3 @15,000 RPM	£139.00
OM31857	BT50 FMB 40	40mm	60	AD/B + Cool	G2.5 @25,000 RPM	£64.00
OM31858			100	AD/B + Cool	G2.5 @25,000 RPM	£72.00
OM31859			160	AD/B + Cool	G6.3 @15,000 RPM	£149.00
OM31860			200	AD/B + Cool	G6.3 @15,000 RPM	£203.00
OM31861	BT50 FMB 40	40mm	250	AD/B + Cool	G6.3 @15,000 RPM	£296.00



ANTI-VIBRATION FACE MILL ARBORS BT40 & BT50

- BT MAS403 (JIS 6339)
- For Mounting Face Mill Cutters
- Form AD - Through Spindle Coolant

Part Number	Description	Spigot Size	Gauge Length (mm)	Balance	Price
OM33750	BT40 FMB AV 16	16mm	200	G6.3 @8,000 RPM	£159.00
OM33751			300	G6.3 @8,000 RPM	£239.00
OM33752	BT40 FMB AV 22	22mm	200	G6.3 @8,000 RPM	£159.00
OM33753			300	G6.3 @8,000 RPM	£239.00
OM33754	BT40 FMB AV 27	27mm	200	G6.3 @8,000 RPM	£159.00

OM33755	BT50 FMB AV 16	16mm	200	G6.3 @8,000 RPM	£195.00
OM33756			300	G6.3 @8,000 RPM	£269.00
OM33757			400	G6.3 @8,000 RPM	£339.00
OM33758	BT50 FMB AV 22	22mm	200	G6.3 @8,000 RPM	£195.00
OM33759			300	G6.3 @8,000 RPM	£269.00
OM33760			400	G6.3 @8,000 RPM	£339.00
OM33761	BT50 FMB AV 27	27mm	200	G6.3 @8,000 RPM	£195.00
OM33762			300	G6.3 @8,000 RPM	£269.00
OM33763			400	G6.3 @8,000 RPM	£339.00
OM33764	BT50 FMB AV 32	32mm	300	G6.3 @8,000 RPM	£269.00



COMBI SHELL MILL ARBORS BT30, BT40 & BT50

- BT MAS403 (JIS 6339)
- For Mounting Face Mills & Side/Face Cutters
- G6.3 @ 15,000 RPM

Part Number	Description	Spigot Size	Gauge Length (mm)	Price
OM31001	BT30 COMBI 16	16mm	55	£34.00
OM31002	BT30 COMBI 22	22mm	55	£34.00
OM31003	BT30 COMBI 27	27mm	55	£34.00

OM31031	BT40 COMBI 16	16mm	55	£34.00
OM31030			100	£46.00
OM31033	BT40 COMBI 22	22mm	55	£34.00
OM31032			100	£46.00
OM31035	BT40 COMBI 27	27mm	55	£34.00
OM31034			100	£46.00
OM31036	BT40 COMBI 32	32mm	60	£34.00
OM31037	BT40 COMBI 40	40mm	60	£40.00

OM31104	BT50 COMBI 16	16mm	70	£59.00
OM31105	BT50 COMBI 22	22mm	70	£59.00
OM31527	BT50 COMBI 27	27mm	70	£59.00
OM31110	BT50 COMBI 32	32mm	75	£59.00
OM31113	BT50 COMBI 40	40mm	75	£59.00



BT
(MAS403)

BT
(MAS403)

MORSE TAPER ADAPTORS BT30, BT40 & BT50

- BT MAS403 (JIS 6339)
- For Tools with Morse Taper Shank & Tang
- G2.5 @ 20,000 RPM

Part Number	Description	Gauge Length (mm)	Form	Balance	Price
OM31014	BT30 MTA 1	45	AD	G2.5 @ 20,000 RPM	£34.00
OM31015	BT30 MTA 2	60	AD	G2.5 @ 20,000 RPM	£34.00
OM31016	BT30 MTA 3	75	AD	G2.5 @ 20,000 RPM	£34.00

OM31073	BT40 MTA 1	50	AD	G2.5 @ 20,000 RPM	£29.00
OM31074	BT40 MTA 2	50	AD	G2.5 @ 20,000 RPM	£29.00
OM31075	BT40 MTA 3	70	AD	G2.5 @ 20,000 RPM	£29.00
OM31076	BT40 MTA 4	95	AD	G2.5 @ 20,000 RPM	£29.00

OM31148	BT50 MTA 1	45	AD	G6.3 @ 15,000 RPM	£54.00
OM31149	BT50 MTA 2	50	AD	G6.3 @ 15,000 RPM	£54.00
OM31150	BT50 MTA 3	65	AD	G6.3 @ 15,000 RPM	£54.00
OM31151	BT50 MTA 4	95	AD	G6.3 @ 15,000 RPM	£54.00
OM31152	BT50 MTA 5	105	AD	G6.3 @ 15,000 RPM	£59.00



SYNCHRO TAPPING CHUCKS BT30, BT40 & BT50

- BT MAS403 (JIS 6339)
- Minimum Length Compensation Tapping Chucks
- +/-0.5mm Compression & Expansion
- High Concentricity Enables High Speed Tapping
- Recommended for use with QCTC Type Collets
- QCTC Collets – Pg. 186
- Spares – Pg. 214

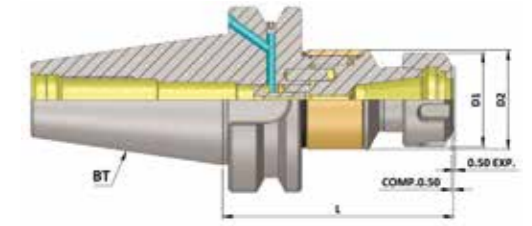

Part Number	Description	Capacity	Clamping Range (mm)	Collet Nut	Form	Dimensions (mm)					Price
						D1	D2	L	Comp.	Exp.	
OM32382	BT30 MLC ER16	M3-M12	1-10	ER16	AD	32	34	79	0.5	0.5	£142.00
OM32383	BT30 MLC ER20	M3-M16	3.5-10	ER20	AD	35	34	80	0.5	0.5	£142.00

OM32384	BT40 MLC ER16	M3-M12	1-10	ER16	AD/B	32	34	79	0.5	0.5	£132.00
OM32385	BT40 MLC ER20	M3-M16	3.5-10	ER20	AD/B	35	34	85	0.5	0.5	£142.00
OM32386	BT40 MLC ER25	M3-M20	3.5-16	ER25	AD/B	42	34	89	0.5	0.5	£142.00
OM32418	BT40 MLC ER32	M4-M27	3.5-20	ER32	AD/B	50	45	110	0.5	0.5	£146.00
OM32433	BT40 MLC ER40	M6-M33	6-26	ER40	AD/B	63	62	115	0.5	0.5	£153.00

OM32434	BT50 MLC ER16	M3-M12	1-10	ER16	AD/B	32	34	95	0.5	0.5	£162.00
OM32435	BT50 MLC ER20	M3-M16	3.5-10	ER20	AD/B	35	34	100	0.5	0.5	£174.00
OM32436	BT50 MLC ER25	M3-M20	3.5-16	ER25	AD/B	42	34	110	0.5	0.5	£174.00
OM32437	BT50 MLC ER32	M4-M27	3.5-20	ER32	AD/B	50	45	120	0.5	0.5	£182.00
OM32438	BT50 MLC ER40	M6-M33	6-26	ER40	AD/B	63	62	120	0.5	0.5	£189.00



MORSE TAPER ADAPTORS WITH DRAWBAR THREAD BT40

- BT MAS403 (JIS 6339)
- For Tools with Morse Taper & Drawbar Thread
- G6.3 @ 15,000 RPM
- Includes internal cap head bolt to retain tool

Part Number	Description	Gauge Length (mm)	Price
OM30269	BT40 MTB 1	45	£44.00
OM30270	BT40 MTB 2	60	£44.00
OM30271	BT40 MTB 3	75	£44.00
OM30272	BT40 MTB 4	100	£44.00



QUICK CHANGE TAPPING CHUCKS BT40 & BT50

- BT MAS403 (JIS 6339)
- Axial Length Compensation
- With Tension & Compression
- Quick change tap adaptors available in 3 sizes
- QC Tap Adaptors – Pg. 192

Part Number	Description	Gauge Length (mm)	Tapping Range	Price
OM31097	BT40 Size 1 (TC312-65)	65	M3 - M12	£96.00
OM31098	BT40 Size 2 (TC820-93)	93	M6 - M20	£98.00
OM31385	BT40 Size 3 (TC1433-142)	142	M14 - M36	£195.00

OM31386	BT50 Size 1 (TC312-100)	100	M3 - M12	£149.00
OM31387	BT50 Size 2 (TC820-100)	100	M6 - M20	£169.00
OM31388	BT50 Size 3 (TC1433-142)	142	M14 - M36	£259.00



HEX KEY PREMIUM DRILL CHUCKS BT40 & BT50

- BT MAS403 (JIS 6339)
- Premium Drill Chuck
- Strong Clamping Force in both clockwise & anti-clockwise operations
- Increased wear-resistance with Titanium Jaws
- Spare Hex Key – Pg. 217

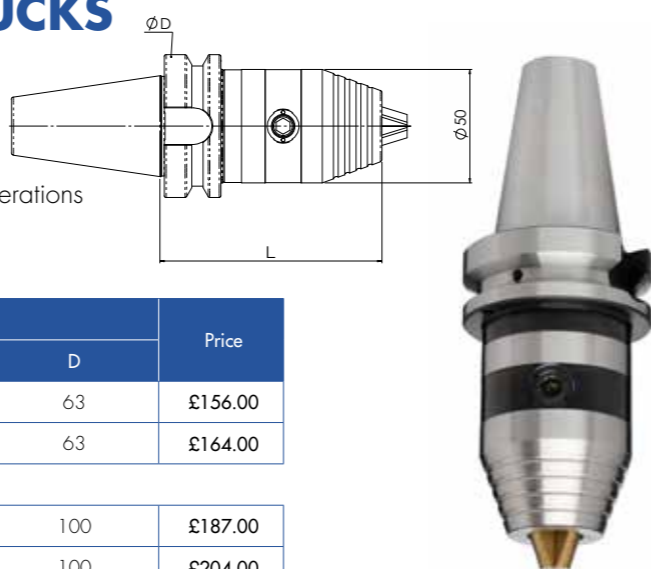

Part Number	Description	Dimensions (mm)			Price
		Capacity	L	D	
OM33658	BT40 GHK 13 98	0.3-13	98	63	£156.00
OM33659	BT40 GHK 16 103	1.5-16	103	63	£164.00
OM33660	BT50 GHK 13 109	0.3-13	109	100	£187.00
OM33661	BT50 GHK 16 114	1.5-16	114	100	£204.00

NCDC DRILL CHUCKS BT30, BT40 & BT50

- BT MAS403 (JIS 6339)
- High Accuracy Drill Chuck
- Maximum Rigidity
- NCDC Spanner – Pg. 217

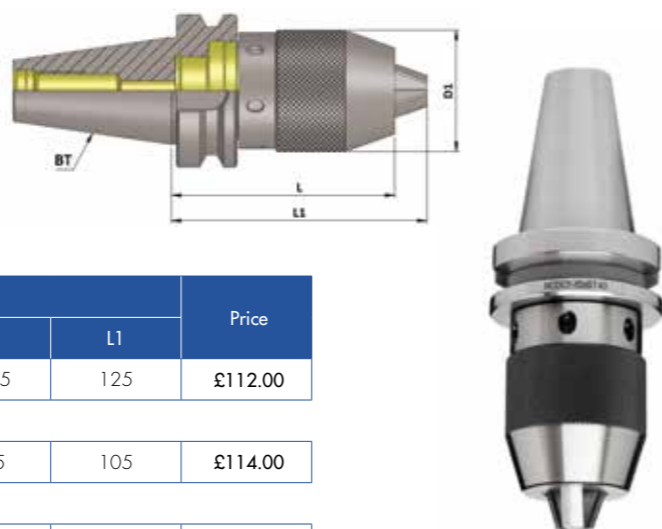

Part Number	Description	Dimensions (mm)				Price
		Capacity	D1	L	L1	
OM33652	BT30 NCDC 1-13mm	1-13mm	50	112.5	125	£112.00
OM33653	BT40 NCDC 1-13mm	1-13mm	50	92.5	105	£114.00
OM33654	BT50 NCDC 1-13mm	1-13mm	50	107.5	120	£180.00

APU KEYLESS DRILL CHUCKS BT30, BT40 & BT50

- BT MAS403 (JIS 6339)
- Economy drill chuck for general engineering applications
- APU Spanner – Pg. 217

Part Number	Description	Gauge Length (mm)	Capacity	Price
OM31000	BT30 APU13 1-13mm	110	1-13mm	£89.00
OM31026	BT40 APU13 1-13mm	100	1-13mm	£83.00
OM31028	BT40 APU16 3-16mm	120	3-16mm	£83.00
OM31100	BT50 APU13 1-13mm	100	1-13mm	£99.00
OM31101	BT50 APU16 3-16mm	120	3-16mm	£99.00

DRILL CHUCK ADAPTORS BT30, BT40 & BT50

- BT MAS403 (JIS 6339)
- For Mounting Drill Chucks
- Drill Chucks – Pg. 204

Part Number	Description	Balance	Price
OM31013	BT30 JT6	G6.3 @ 12,000 RPM	£31.00
OM31532	BT30 B16	G6.3 @ 12,000 RPM	£31.00
OM31072	BT40 JT6	G6.3 @ 12,000 RPM	£31.00
OM31029	BT40 B16	G6.3 @ 12,000 RPM	£31.00
OM31147	BT50 JT6	G6.3 @ 12,000 RPM	£52.00
OM31533	BT50 B16	G6.3 @ 12,000 RPM	£52.00



TEST ARBORS BT30, BT40 & BT50

- BT MAS403 (JIS 6339)
- Master Mandrel
- Supplied with protective wooden case

Part Number	Description	Diameter (mm)	Gauge Length (mm)	Price
OM33741	BT30 Test Arbor	32	250	£149.00
OM33742	BT40 Test Arbor	40	300	£206.00
OM33743	BT50 Test Arbor	50	350	£345.00



MACHINABLE BORING BAR BLANK BT40 & BT50

- BT MAS403 (JIS 6339)
- Machinable Boring Bar Blank

Part Number	Description	Diameter (mm)	Gauge Length (mm)	Price
OM30291	BT40 BLANK 63 250	63	250	£82.00
OM30292	BT50 BLANK 97 315	97	315	£152.00



DIN 69871

DIN 69871 TECHNICAL SPECIFICATION

- Manufactured with Casehardening Steel
- Surface Hardened HRC 60+2
- Hardening Depth 0.8mm+0.2mm
- Taper Angle Tolerance AT3

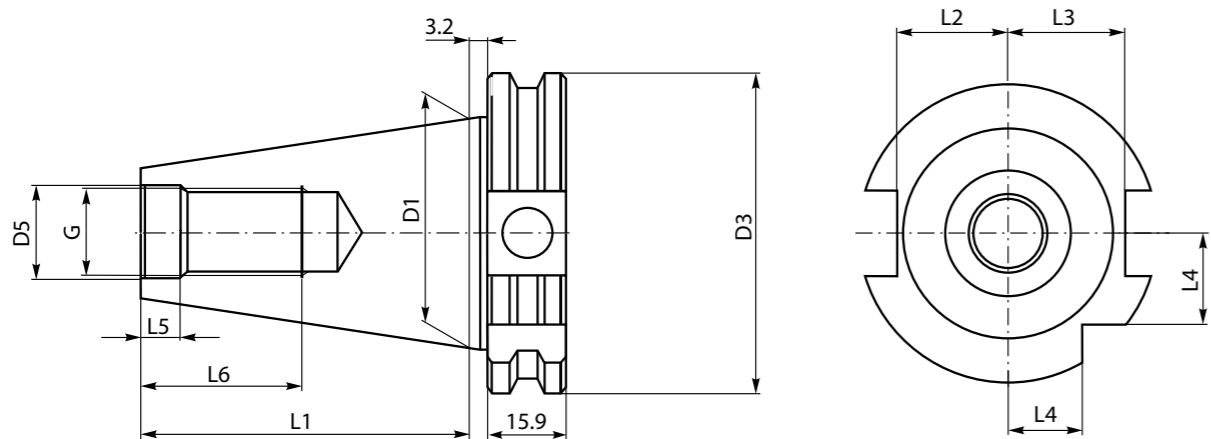

Taper	D1	G	D5	D3	L1	L2	L3	L4	L5	L6
30	31.75	M12	12.5	50.00	47.80	16.4	19.0	15.0	5.5	24
40	44.45	M16	17.0	63.55	68.40	22.8	25.0	18.5	8.2	32
50	69.85	M24	25.0	97.50	101.75	35.5	37.7	30.0	11.5	47

Form AD

Through Spindle Coolant

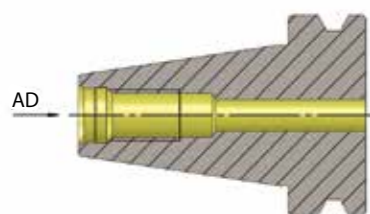

Form AD/B

Through Spindle Coolant & Through Flange Coolant

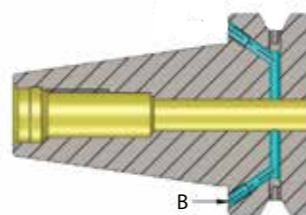

ER MINI NUT COLLET CHUCKS DV40

- DIN 69871
- MINI Nut ER Collet Chucks
- Slimline Extended Mini Chucks
- ER Collets – Pg. 154
- Spares – Pg. 214

Part Number	Description	Gauge Length (mm)	Form	Nut	Balance	Price
OM30285	DV40 ER11 MINI	70	AD	ER11 Mini (OM31414)	G2.5 @20,000 RPM	£37.00
OM31700		70	AD/B		G2.5 @25,000 RPM	£44.00
OM31550		100	AD		G6.3 @15,000 RPM	£37.00
OM31701		100	AD/B		G2.5 @25,000 RPM	£44.00
OM31702		160	AD/B		G2.5 @25,000 RPM	£71.00
OM30286	DV40 ER16 MINI	70	AD	ER16 Mini (OM31415)	G2.5 @20,000 RPM	£37.00
OM31703		70	AD/B		G2.5 @25,000 RPM	£44.00
OM31551		100	AD		G6.3 @15,000 RPM	£37.00
OM31704		100	AD/B		G2.5 @25,000 RPM	£44.00
OM31705		160	AD/B		G2.5 @25,000 RPM	£71.00
OM30288		200	AD		G2.5 @20,000 RPM	£89.00



SHORT ER COLLET CHUCK DV40

- DIN 69871
- Very Short for maximum rigidity
- ER32 Collets – Pg. 158
- Spares – Pg. 214

Part Number	Description	Gauge Length (mm)	Form	Balance	Price
OM30295	DV40 N ER32 SHORT	35	AD	G2.5 @25,000 RPM	£52.00



ER COLLET CHUCKS DV30

- DIN 69871
- Standard Nut Collet Chucks
- ER Collet System
- ER Collets – Pg. 154
- Spares – Pg. 214

Part Number	Description	Gauge Length (mm)	Form	Nut	Balance	Price
OM30299	DV30 ER16	70	AD	ER16 Hexagon (OM31426)	G2.5 @20,000 RPM	£37.00
OM30468	DV30 ER25	70	AD	ER25 Castellated (OM31421)	G2.5 @20,000 RPM	£37.00
OM30309	DV30 ER32	70	AD	ER32 Castellated (OM31422)	G2.5 @20,000 RPM	£37.00



ER COLLET CHUCKS DV40

- DIN 69871
- Standard Nut Collet Chucks
- ER Collet System
- Wide Range of gauge lengths available
- ER Collets – Pg. 154
- Spares – Pg. 214

Part Number	Description	Gauge Length (mm)	Form	Nut	Balance	Price
OM31180	DV40 ER16	70	AD	ER16 Hexagon (OM31426)	G2.5 @20,000 RPM	£24.00
OM31706		70	AD/B		G2.5 @25,000 RPM	£34.00
OM31179		100	AD		G2.5 @20,000 RPM	£27.00
OM31707		100	AD/B		G2.5 @25,000 RPM	£37.00
OM31708		120	AD/B		G2.5 @25,000 RPM	£44.00
OM31447		160	AD		G2.5 @20,000 RPM	£47.00
OM31709		160	AD/B		G2.5 @25,000 RPM	£56.00
OM31710		200	AD/B		G2.5 @25,000 RPM	£83.00
OM31568		DV40 ER20	70		AD	ER20 Castellated (OM31420)
OM31569	100		AD	G6.3 @15,000 RPM	£27.00	
OM31570	160		AD	G6.3 @15,000 RPM	£52.00	
OM31184	DV40 ER25	70	AD	ER25 Castellated (OM31421)	G2.5 @20,000 RPM	£24.00
OM31711		70	AD/B		G2.5 @25,000 RPM	£34.00
OM31181		100	AD		G2.5 @20,000 RPM	£27.00
OM31712		100	AD/B		G2.5 @25,000 RPM	£37.00
OM31713		120	AD/B		G2.5 @25,000 RPM	£44.00
OM31182		150	AD		G2.5 @20,000 RPM	£47.00
OM31714		160	AD/B		G2.5 @25,000 RPM	£56.00
OM31715		200	AD/B		G2.5 @25,000 RPM	£83.00
OM31188		DV40 ER32	70		AD	ER32 Castellated (OM31422)
OM31716	70		AD/B	G2.5 @25,000 RPM	£34.00	
OM31185	100		AD	G2.5 @20,000 RPM	£27.00	
OM31717	100		AD/B	G2.5 @25,000 RPM	£37.00	
OM31718	120		AD/B	G2.5 @25,000 RPM	£44.00	
OM31186	150		AD	G2.5 @20,000 RPM	£47.00	
OM31187	160		AD	G2.5 @20,000 RPM	£47.00	
OM31719	160		AD/B	G2.5 @25,000 RPM	£56.00	
OM31478	200		AD	G2.5 @20,000 RPM	£83.00	
OM31720	200		AD/B	G2.5 @25,000 RPM	£88.00	
OM31721	250		AD/B	G2.5 @25,000 RPM	£93.00	
OM31722	300	AD/B	G2.5 @25,000 RPM	£104.00		
OM31191	DV40 ER40	80	AD	ER40 Castellated (OM31423)	G2.5 @20,000 RPM	£24.00
OM31723		80	AD/B		G2.5 @25,000 RPM	£34.00
OM31724		100	AD/B		G2.5 @25,000 RPM	£37.00
OM31725		160	AD/B		G2.5 @25,000 RPM	£56.00
OM31726	DV40 ER50	100	AD/B	ER50 Castellated (OM31424)	G2.5 @25,000 RPM	£62.00



ER COLLET CHUCKS DV50

- DIN 69871
- Standard Nut Collet Chucks
- ER Collet System
- Wide range of gauge lengths available
- ER Collets – Pg. 154
- Spares – Pg. 214

Part Number	Description	Gauge Length (mm)	Form	Nut	Balance	Price		
OM31232	DV50 ER16	70	AD	ER16 Hexagon (OM31426)	G6.3 @15,000 RPM	£48.00		
OM31864		70	AD/B		G2.5 @25,000 RPM	£57.00		
OM31479		100	AD		G6.3 @15,000 RPM	£58.00		
OM31865		100	AD/B		G2.5 @25,000 RPM	£67.00		
OM31481		160	AD		G6.3 @15,000 RPM	£75.00		
OM31866		160	AD/B		G2.5 @25,000 RPM	£84.00		
OM31867		200	AD/B		G2.5 @25,000 RPM	£149.00		
OM31235		DV50 ER25	70		AD	ER25 Castellated (OM31421)	G6.3 @15,000 RPM	£48.00
OM31868			70		AD/B		G2.5 @25,000 RPM	£57.00
OM31471	100		AD	G6.3 @15,000 RPM	£58.00			
OM31869	100		AD/B	G2.5 @25,000 RPM	£67.00			
OM31233	160		AD	G6.3 @15,000 RPM	£75.00			
OM31870	160		AD/B	G2.5 @25,000 RPM	£84.00			
OM31473	200		AD	G6.3 @15,000 RPM	£125.00			
OM31871	200		AD/B	G2.5 @25,000 RPM	£132.00			
OM31872	250		AD/B	G2.5 @25,000 RPM	£149.00			
OM31237	DV50 ER32	80	AD	ER32 Castellated (OM31422)	G6.3 @15,000 RPM	£48.00		
OM31873		80	AD/B		G2.5 @25,000 RPM	£57.00		
OM31450		100	AD		G6.3 @15,000 RPM	£58.00		
OM31874		100	AD/B		G2.5 @25,000 RPM	£67.00		
OM31236		160	AD		G6.3 @15,000 RPM	£75.00		
OM31875		160	AD/B		G2.5 @25,000 RPM	£84.00		
OM31474		200	AD		G6.3 @15,000 RPM	£125.00		
OM31876		200	AD/B		G2.5 @25,000 RPM	£132.00		
OM31877		250	AD/B		G2.5 @25,000 RPM	£149.00		
OM31238	DV50 ER40	80	AD	ER40 Castellated (OM31423)	G6.3 @15,000 RPM	£48.00		
OM31878		80	AD/B		G2.5 @25,000 RPM	£57.00		
OM31475		100	AD		G6.3 @15,000 RPM	£58.00		
OM31879		100	AD/B		G2.5 @25,000 RPM	£67.00		
OM31880		160	AD/B		G2.5 @25,000 RPM	£84.00		
OM31881		200	AD/B		G2.5 @25,000 RPM	£132.00		
OM31882	DV50 ER50	100	AD/B	ER50 Castellated (OM31424)	G2.5 @25,000 RPM	£89.00		



DIN 69871

81

OZ COLLET CHUCKS DV40

- DIN 69871
- OZ Collet System (DIN6388)
- Balanced G6.3 @ 15,000 RPM
- OZ Collets - Pg. 180
- Spares - Pg. 214

Part Number	Description	Gauge Length (mm)	Form	Price
OM30289	DV40 OZ 25	80	AD	£50.00
OM30290	DV40 OZ 32	90	AD	£59.00



GSK COLLET CHUCKS DV40

- DIN69871
- High Accuracy GSK Collet Chucks
- Excellent for use in high speed cutting and precise milling
- Balanced to G2.5 25,000 RPM
- GSK Collets - Pg. 182
- Spares - Pg. 214

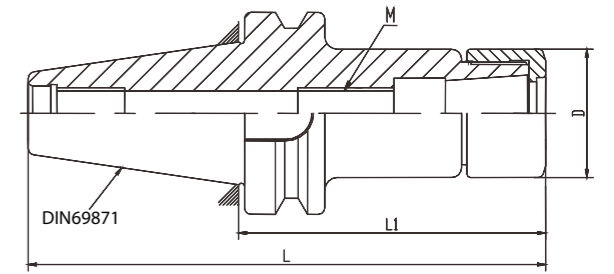

Part Number	Description	Dimensions (mm)			Price
		Gauge Length	D	M	
OM30449	DV40 GSK 06	60	19.5	M8 x 1	£67.00
OM30443		90			£67.00
OM30498		120			£78.00
OM30444		150			£87.00
OM30445	DV40 GSK 10	60	27	M11 x 1	£67.00
OM30446		90			£67.00
OM30447		120			£78.00
OM30448		150			£89.00
OM30450	DV40 GSK 16	60	40	M18 x 1.5	£67.00
OM30451		90			£67.00
OM30452		120			£78.00
OM30453		150			£89.00
OM30454	DV40 GSK 25	200	55	M28 x 1.5	£109.00
OM30455		90			£78.00
OM30456		120			£96.00
OM30457		150			£102.00



DMC COLLET CHUCKS DV40 & DV50

- DIN69871
- Drawback Collet Style
- Ultra Precision DMC Slim Collet Chucks
- High Accuracy <0.005mm
- Balanced to G2.5 @ 25,000 RPM
- DMC Collets - Pg. 184
- Hex Keys - Pg. 217

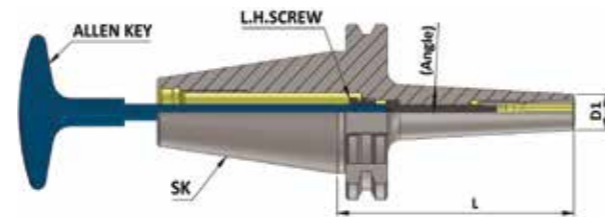

Part Number	Description	Dimensions (mm)			Angle	Collet	Screw	Allen Key	Price
		Clamping Range	D1	L					
OM32357	DV40 DMC 06	3-6	13	60	3°	DMC 06	M5	4X200	£79.00
OM32358		3-6	13	90	3°	DMC 06	M5	4X200	£79.00
OM32359		3-6	13	120	3°	DMC 06	M5	4X200	£89.00
OM32360		3-6	13	160	3°	DMC 06	M5	4X200	£94.00
OM32361	DV40 DMC 08	3-8	22	90	3°	DMC 08	M6	5X200	£79.00
OM32362		3-8	22	120	3°	DMC 08	M6	5X200	£89.00
OM32363		3-8	22	160	3°	DMC 08	M6	5X200	£94.00
OM32364	DV40 DMC 10	3-10	28	90	3°	DMC 10	M8	6X200	£79.00
OM32365		3-10	28	120	3°	DMC 10	M8	6X200	£89.00
OM32366	DV50 DMC 10	3-10	28	150	3°	DMC 10	M8	6X200	£119.00



DIN 69871

DIN 69871

HYDRAULIC EXPANSION CHUCKS DV40 & DV50

- DIN69871
- Ultra Precision Hydraulic Chucks
- High Accuracy <0.005mm
- Balanced to G2.5 @ 25,000 RPM
- Spares – Pg. 216

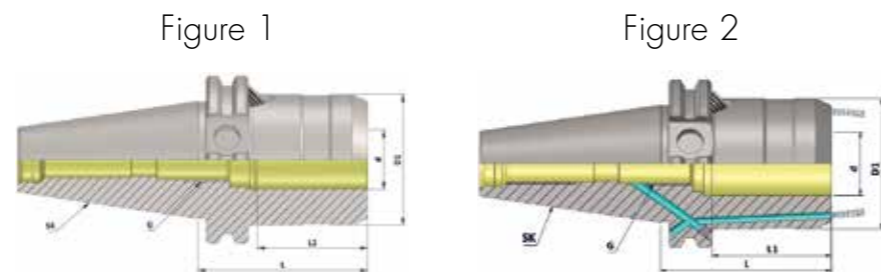

Part Number	Description	Dimensions (mm)					Form	Fig.	Price
		d	D1	G	L	L1			
OM32156	DV40 HC12S	12	42	M10	50	40	AD	Fig. 1	£138.00
OM32161		12	42	M10	50	40	AD/B + Cool	Fig. 2	£178.00
OM32157	DV40 HC20S	20	50	M16	64.5	42	AD	Fig. 1	£138.00
OM32162		20	50	M16	64.5	42	AD/B + Cool	Fig. 2	£178.00

OM32158	DV50 HC12S	12	42	M10	50.5	40	AD	Fig. 1	£186.00
OM32163		12	42	M10	50	40	AD/B + Cool	Fig. 2	£198.00
OM32159	DV50 HC20S	20	50	M16	64.5	42	AD	Fig. 1	£186.00
OM32164		20	50	M16	64.5	42	AD/B + Cool	Fig. 2	£198.00
OM32160	DV50 HC32S	32	72	M16	81	55	AD	Fig. 1	£192.00
OM32165		32	72	M16	81	55	AD/B + Cool	Fig. 2	£208.00



Hydraulic Chuck Kit

Part Number	Description	Price
OM36188	DV40 HC20 Kit DV40 20mm Chuck + 5 Collets: 6, 8, 10, 12 & 16mm Collets	£365.00



PREMIUM POWER MILLING CHUCKS DV40 & DV50

- DIN 69871
- High Accuracy <0.005mm
- Power Milling Chucks are subjected to sub-zero treatment (-90° C). This helps prevent any deformation, increasing tool life
- Balanced G6.3 @ 15,000 RPM
- Straight Collets – Pg. 185
- Spares – Pg. 214

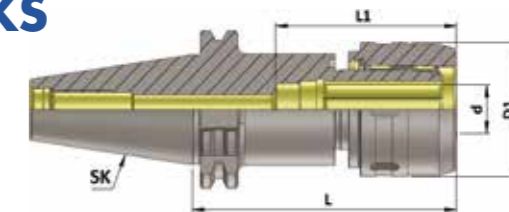

Part Number	Description	Dimensions (mm)				Price
		d	D1	L	L1	
OM31091	DV40 UPMC 20	20	54	105	70	£154.00
OM31092	DV40 UPMC 32	32	72	105	70	£164.00
OM31189	DV50 UPMC 20	20	54	105	100	£186.00
OM31190	DV50 UPMC 32	32	72	105	100	£219.00



STANDARD POWER MILLING CHUCKS DV40 & DV50

- DIN 69871
- Economy chuck for general engineering applications
- Straight Collets – Pg. 184
- Spares – Pg. 214

Part Number	Description	Clamping Size (mm)	Gauge Length (mm)	Price
OM31389	DV40 SC 20mm	20	80	£104.00
OM31390	DV40 SC 25mm	25	80	£104.00
OM31391	DV40 SC 32mm	32	105	£104.00
OM30296	DV50 SC 25mm	25	110	£132.00
OM30297	DV50 SC 32mm	32	110	£132.00



SHRINK FIT CHUCKS DV40

- DIN 69871
- Superior Clamping Strength & Rigidity
- Form AD/B
- 4.5 Degree
- Balanced G2.5 @ 25,000 RPM

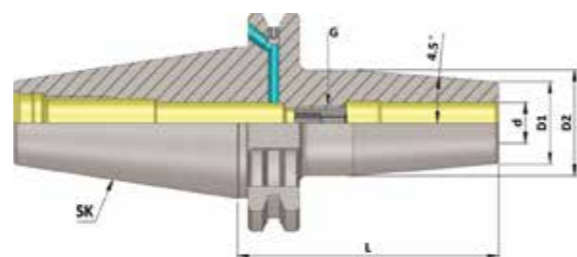

Part Number	Description	Dimensions (mm)					Price
		d	D1	D2	G	L	
OM30886	DV40 SF03	3mm	10	20	-	80	£92.00
OM30887			10	20	-	120	£119.00
OM30888			10	20	-	160	£145.00
OM30824	DV40 SF04	4mm	15	22	-	80	£92.00
OM30889			15	22	-	120	£119.00
OM30890			15	22	-	160	£145.00
OM30891	DV40 SF05	5mm	15	22	-	80	£92.00
OM30892			15	22	-	120	£119.00
OM30893			15	22	-	160	£145.00
OM30825	DV40 SF06	6mm	21	27	M5	80	£72.00
OM30826			21	27	M5	120	£92.00
OM30827			21	27	M5	160	£119.00
OM34343	DV40 SF08	8mm	21	27	M5	200	£165.00
OM30828			21	27	M6	80	£72.00
OM30829			21	27	M6	120	£92.00
OM30830	DV40 SF10	10mm	21	27	M6	160	£119.00
OM34344			21	27	M6	200	£165.00
OM30831			24	31	M8	80	£72.00
OM30832	DV40 SF12	12mm	24	31	M8	120	£92.00
OM30833			24	31	M8	160	£119.00
OM34345			24	31	M8	200	£165.00
OM30834	DV40 SF14	14mm	24	31	M10	80	£72.00
OM30835			24	31	M10	120	£92.00
OM30836			24	31	M10	160	£119.00
OM34346	DV40 SF16	16mm	24	31	M10	200	£165.00
OM30894			27	34	M10	80	£72.00
OM30895			27	34	M10	120	£92.00
OM30896	DV40 SF18	18mm	27	34	M10	160	£119.00
OM30837			27	34	M12	80	£72.00
OM30838			27	34	M12	120	£92.00
OM30839	DV40 SF20	20mm	27	34	M12	160	£119.00
OM34348			27	34	M12	200	£165.00
OM30897			33	40	M12	80	£72.00
OM30898	DV40 SF25	25mm	33	40	M12	120	£92.00
OM30899			33	40	M12	160	£119.00
OM30840			33	40	M16	80	£72.00
OM30841	DV40 SF32	32mm	33	40	M16	120	£92.00
OM30842			33	40	M16	160	£119.00
OM34350			33	40	M16	200	£165.00
OM30843	DV40 SF25	25mm	44	53	M16	100	£72.00
OM30844			44	53	M16	120	£92.00
OM30845			44	53	M16	160	£119.00
OM30846	DV40 SF32	32mm	44	53	M16	100	£72.00
OM30900			44	53	M16	120	£92.00
OM30847			44	53	M16	160	£119.00

MILLING CUTTER ARBORS DV40 & DV50

- DIN 69871
- Arbors for Screw Type Modular Milling Cutters
- Balanced to G2.5 @ 25,000RPM
- Form AD/B

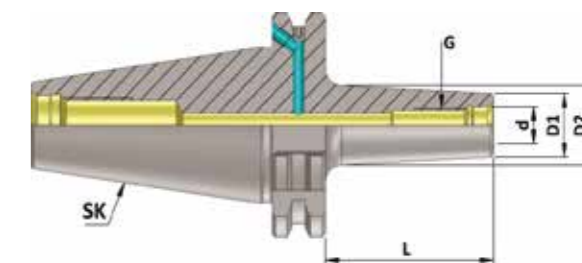

Part Number	Description	Dimensions (mm)					Price
		d	D1	D2	G	L	
OM30950	DV40 MCA 06	6.5	10	13	M6	25	£62.00
OM30951		6.5	10	20		50	£72.00
OM30952		6.5	10	23		75	£78.00
OM30953	DV40 MCA 08	8.5	13	15	M8	25	£62.00
OM30954		8.5	13	23		50	£72.00
OM30955		8.5	13	23		75	£78.00
OM30956	DV40 MCA 10	8.5	13	25	M10	100	£88.00
OM30957		10.5	18	20		25	£62.00
OM30958		10.5	18	23		50	£72.00
OM30959	DV40 MCA 12	10.5	18	28	M12	75	£78.00
OM30960		10.5	18	32		100	£88.00
OM30961		12.5	21	24		25	£62.00
OM30962	DV40 MCA 16	12.5	21	24	M16	50	£72.00
OM30963		12.5	21	31		75	£78.00
OM30964		12.5	21	33		100	£88.00
OM30965	DV50 MCA 08	12.5	21	36	M16	125	£100.00
OM30966		17	29	29		25	£62.00
OM30967		17	29	34		50	£72.00
OM30968	DV50 MCA 10	17	29	34	M10	75	£78.00
OM30969		17	29	36		100	£88.00
OM30970		17	29	40		125	£100.00
OM30971	DV50 MCA 12	17	29	42.5	M12	150	£110.00
OM30972		8.5	13	23		50	£88.00
OM30973		8.5	13	25		100	£109.00
OM30974	DV50 MCA 16	8.5	13	30	M16	150	£120.00
OM30975		10.5	18	23		50	£88.00
OM30976		10.5	18	32		100	£109.00
OM30977	DV50 MCA 20	10.5	18	36.5	M20	150	£120.00
OM30978		12.5	21	24		50	£88.00
OM30979		12.5	21	33		100	£109.00
OM30980	DV50 MCA 25	12.5	21	40	M25	150	£120.00
OM30981		17	29	34		50	£88.00
OM30982		17	29	36		100	£109.00
OM30983	DV50 MCA 32	17	29	42.5	M32	150	£120.00

DIN 69871

PARALLEL MILLING CUTTER ARBORS DV40

- DIN 69871
- Arbors for Screw Type Modular Milling Cutters
- Balanced to G2.5 @ 25,000RPM
- Form AD/B

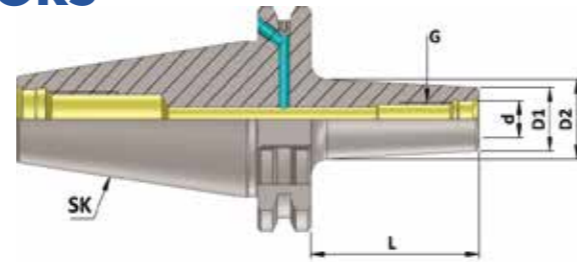

Part Number	Description	Dimensions (mm)					Price
		d	D1	D2	G	L	
OM34725	DV40 MCAP 08	8.5	13.8	13.8	M8	50	£79.00
OM34728	DV40 MCAP 10	10.5	18	18	M10	50	£79.00
OM34729		10.5	18	18		75	£86.00
OM34730		10.5	18	18		100	£98.00
OM34731	DV40 MCAP 12	12.5	21	21	M12	50	£79.00
OM34732		12.5	21	21		75	£86.00
OM34733		12.5	21	21		100	£98.00
OM34735	DV40 MCAP 16	17	29	29	M16	50	£79.00
OM34736		17	29	29		75	£86.00
OM34737		17	29	29		100	£98.00

END MILL HOLDERS DV40

- DIN 69871
- For mounting straight shank tools with weldon flat
- Spare Clamp Screws – Pg. 218



Part Number	Description	Bore Size	Gauge Length (mm)	Form	Balance	Price
OM31206	DV40 S/L 06	6mm	50	AD	G2.5 @20,000 RPM	£24.00
OM31727			50	AD/B	G2.5 @25,000 RPM	£34.00
OM31461			100	AD	G2.5 @20,000 RPM	£29.00
OM31728			100	AD/B	G2.5 @25,000 RPM	£39.00
OM31729			160	AD/B	G2.5 @25,000 RPM	£51.00
OM36214			200	AD	G6.3 @15,000 RPM	£98.00
OM31207	DV40 S/L 08	8mm	50	AD	G2.5 @20,000 RPM	£24.00
OM31731			50	AD/B	G2.5 @25,000 RPM	£34.00
OM31462			100	AD	G2.5 @20,000 RPM	£29.00
OM31732			100	AD/B	G2.5 @25,000 RPM	£39.00
OM31733			160	AD/B	G2.5 @25,000 RPM	£51.00
OM36215			200	AD	G6.3 @15,000 RPM	£98.00
OM31208	DV40 S/L 10	10mm	63	AD	G2.5 @20,000 RPM	£24.00
OM31735			63	AD/B	G2.5 @25,000 RPM	£34.00
OM31463			100	AD	G2.5 @20,000 RPM	£29.00
OM31736			100	AD/B	G2.5 @25,000 RPM	£39.00
OM31737			160	AD/B	G2.5 @25,000 RPM	£51.00
OM36216			200	AD	G6.3 @15,000 RPM	£98.00
OM31209	DV40 S/L 12	12mm	63	AD	G2.5 @20,000 RPM	£24.00
OM31739			63	AD/B	G2.5 @25,000 RPM	£34.00
OM31464			100	AD	G2.5 @20,000 RPM	£39.00
OM31740			100	AD/B	G2.5 @25,000 RPM	£39.00
OM31741			160	AD/B	G2.5 @25,000 RPM	£51.00
OM36217			200	AD	G6.3 @15,000 RPM	£98.00
OM31980	DV40 S/L 14	14mm	63	AD	G2.5 @20,000 RPM	£31.00
OM30372			100	AD	G2.5 @20,000 RPM	£34.00
OM31467	DV40 S/L 16	16mm	35	AD	G2.5 @20,000 RPM	£37.00
OM31211			63	AD	G2.5 @20,000 RPM	£24.00
OM31743			63	AD/B	G2.5 @25,000 RPM	£34.00
OM31465			100	AD	G2.5 @20,000 RPM	£29.00
OM31744			100	AD/B	G2.5 @25,000 RPM	£39.00
OM30257			160	AD	G2.5 @20,000 RPM	£46.00
OM31745			160	AD/B	G2.5 @25,000 RPM	£54.00
OM30258			200	AD	G2.5 @20,000 RPM	£98.00
OM31981			DV40 S/L 18	18mm	63	AD
OM30782	100	AD			G2.5 @20,000 RPM	£34.00

DIN 69871

END MILL HOLDERS DV40 (Continued)



Part Number	Description	Bore Size	Gauge Length (mm)	Form	Balance	Price
OM31468	DV40 S/L 20	20mm	35	AD	G2.5 @20,000 RPM	£37.00
OM31212			63	AD	G2.5 @20,000 RPM	£24.00
OM31747			63	AD/B	G2.5 @25,000 RPM	£34.00
OM31466			100	AD	G2.5 @20,000 RPM	£29.00
OM31748			100	AD/B	G2.5 @25,000 RPM	£39.00
OM30999			160	AD	G2.5 @20,000 RPM	£46.00
OM31749			160	AD/B	G2.5 @25,000 RPM	£54.00
OM30259			200	AD	G2.5 @20,000 RPM	£98.00
OM31469			DV40 S/L 25	25mm	35	AD
OM30260	70	AD			G2.5 @20,000 RPM	£24.00
OM31214	90	AD			G2.5 @20,000 RPM	£24.00
OM31213	100	AD			G2.5 @20,000 RPM	£29.00
OM31751	100	AD/B			G2.5 @25,000 RPM	£39.00
OM30261	160	AD			G2.5 @20,000 RPM	£46.00
OM31752	160	AD/B			G2.5 @25,000 RPM	£54.00
OM30262	200	AD			G2.5 @20,000 RPM	£98.00
OM31470	DV40 S/L 32	32mm			65	AD
OM31215			100	AD	G2.5 @20,000 RPM	£24.00
OM31754			100	AD/B	G2.5 @25,000 RPM	£39.00
OM30263			160	AD	G2.5 @20,000 RPM	£48.00
OM31755			160	AD/B	G2.5 @25,000 RPM	£59.00
OM36218			200	AD	G6.3 @15,000 RPM	£115.00
OM31216	DV40 S/L 40	40mm	115	AD	G2.5 @20,000 RPM	£36.00

END MILL HOLDERS DV50

- DIN 69871
- For mounting straight shank tools with weldon flat
- Spare Clamp Screws – Pg. 218



Part Number	Description	Bore Size	Gauge Length (mm)	Form	Balance	Price
OM31629	DV50 S/L 06	6mm	63	AD/B	G2.5 @25,000 RPM	£52.00
OM31883			100	AD/B	G2.5 @25,000 RPM	£55.00
OM31884			160	AD/B	G2.5 @25,000 RPM	£83.00
OM31630	DV50 S/L 08	8mm	63	AD/B	G2.5 @25,000 RPM	£52.00
OM31886			100	AD/B	G2.5 @25,000 RPM	£55.00
OM31887			160	AD/B	G2.5 @25,000 RPM	£83.00
OM31245	DV50 S/L 10	10mm	63	AD	G6.3 @15,000 RPM	£45.00
OM31889			63	AD/B	G2.5 @25,000 RPM	£51.00
OM31890			100	AD/B	G2.5 @25,000 RPM	£55.00
OM31891			160	AD/B	G2.5 @25,000 RPM	£83.00
OM31246	DV50 S/L 12	12mm	63	AD	G6.3 @15,000 RPM	£45.00
OM31893			63	AD/B	G2.5 @25,000 RPM	£51.00
OM31894			100	AD/B	G2.5 @25,000 RPM	£55.00
OM31895			160	AD/B	G2.5 @25,000 RPM	£83.00
OM36222			200	AD	G6.3 @15,000 RPM	£119.00
OM31247	DV50 S/L 16	16mm	63	AD	G6.3 @15,000 RPM	£45.00
OM31897			63	AD/B	G2.5 @25,000 RPM	£51.00
OM31248			100	AD	G6.3 @15,000 RPM	£51.00
OM31898			100	AD/B	G2.5 @25,000 RPM	£55.00
OM31899			160	AD/B	G2.5 @25,000 RPM	£83.00
OM36223			200	AD	G6.3 @15,000 RPM	£119.00
OM31249	DV50 S/L 20	20mm	63	AD	G6.3 @15,000 RPM	£45.00
OM31901			63	AD/B	G2.5 @25,000 RPM	£51.00
OM31250			100	AD	G6.3 @15,000 RPM	£51.00
OM31902			100	AD/B	G2.5 @25,000 RPM	£55.00
OM31903			160	AD/B	G2.5 @25,000 RPM	£83.00
OM36224			200	AD	G6.3 @15,000 RPM	£119.00
OM31251	DV50 S/L 25	25mm	80	AD	G6.3 @15,000 RPM	£45.00
OM31905			80	AD/B	G2.5 @25,000 RPM	£51.00
OM31252			100	AD	G6.3 @15,000 RPM	£51.00
OM31906			100	AD/B	G2.5 @25,000 RPM	£55.00
OM31907			160	AD/B	G2.5 @25,000 RPM	£83.00
OM36225			200	AD	G6.3 @15,000 RPM	£119.00
OM31253	DV50 S/L 32	32mm	100	AD	G6.3 @15,000 RPM	£45.00
OM31909			100	AD/B	G2.5 @25,000 RPM	£55.00
OM31910			160	AD/B	G2.5 @25,000 RPM	£83.00
OM36226			200	AD	G6.3 @15,000 RPM	£119.00
OM31255	DV50 S/L 40	40mm	120	AD	G6.3 @15,000 RPM	£51.00
OM31912			120	AD/B	G2.5 @25,000 RPM	£65.00
OM31913			160	AD/B	G2.5 @25,000 RPM	£88.00
OM31915	DV50 S/L 50	50mm	120	AD	G6.3 @15,000 RPM	£132.00

DIN 69871

END MILL HOLDERS WITH COOLANT CHANNELS DV40

- DIN 69871
- For mounting straight shank tools with weldon flat
- With Front Face Coolant Channels

Part Number	Description	Bore Size (mm)	Gauge Length (mm)	Form	Balance	Price
OM36227	DV40 S/L 06 FCC	6	50	AD/B	G2.5@25000	£49.00
OM36228	DV40 S/L 08 FCC	8	50	AD/B	G2.5@25000	£49.00
OM36229	DV40 S/L 10 FCC	10	50	AD/B	G2.5@25000	£49.00
OM36230	DV40 S/L 12 FCC	12	50	AD/B	G2.5@25000	£49.00
OM36231	DV40 S/L 16 FCC	16	63	AD/B	G2.5@25000	£49.00
OM36232	DV40 S/L 20 FCC	20	63	AD/B	G2.5@25000	£49.00



STANDARD FACE MILL ARBORS DV40 & DV50

- DIN 69871
- Non Through Coolant
- For Mounting Face Mill Cutters

Part Number	Description	Spigot Size	Gauge Length (mm)	Balance	Price
OM31193	DV40 FMB 16	16mm	35	G2.5 @20,000 RPM	£29.00
OM31489			100	G2.5 @20,000 RPM	£40.00
OM31490			160	G6.3 @15,000 RPM	£71.00
OM30785			200	G6.3 @15,000 RPM	£98.00
OM31195	DV40 FMB 22	22mm	45	G2.5 @20,000 RPM	£29.00
OM31491			100	G2.5 @20,000 RPM	£40.00
OM31492			160	G6.3 @15,000 RPM	£71.00
OM30786			200	G6.3 @15,000 RPM	£98.00
OM31198	DV40 FMB 27	27mm	45	G2.5 @20,000 RPM	£29.00
OM31493			100	G2.5 @20,000 RPM	£40.00
OM31494			160	G6.3 @15,000 RPM	£71.00
OM30787			200	G6.3 @15,000 RPM	£98.00
OM31199	DV40 FMB 32	32mm	50	G2.5 @20,000 RPM	£29.00
OM31200	DV40 FMB 40	40mm	60	G2.5 @20,000 RPM	£38.00
OM31392	DV50 FMB 22	22mm	45	G6.3 @15,000 RPM	£49.00
OM31528	DV50 FMB 27	27mm	45	G6.3 @15,000 RPM	£49.00
OM33689	DV50 FMB 32	32mm	50	G6.3 @15,000 RPM	£49.00
OM33690	DV50 FMB 40	40mm	55	G6.3 @15,000 RPM	£52.00



DIN 69871

DIN 69871

THROUGH COOLANT FACE MILL ARBORS DV40 & DV50

- DIN 69871
- For Mounting Face Mill Cutters
- Wide range of gauge lengths available
- AD/B + Cool Holders allow for coolant through flange and through centre

Part Number	Description	Spigot Size	Gauge Length (mm)	Form	Balance	Price
OM31757	DV40 FMB 16	16mm	35	AD/B + Cool	G2.5 @25,000 RPM	£41.00
OM31758			100	AD/B + Cool	G2.5 @25,000 RPM	£52.00
OM31759			160	AD/B + Cool	G2.5 @25,000 RPM	£83.00
OM31761	DV40 FMB 22	22mm	45	AD/B + Cool	G2.5 @25,000 RPM	£41.00
OM31762			100	AD/B + Cool	G2.5 @25,000 RPM	£52.00
OM31763			160	AD/B + Cool	G2.5 @25,000 RPM	£83.00
OM31764			200	AD/B + Cool	G6.3 @15,000 RPM	£119.00
OM31765	DV40 FMB 27	27mm	45	AD/B + Cool	G2.5 @25,000 RPM	£41.00
OM31766			100	AD/B + Cool	G2.5 @25,000 RPM	£52.00
OM31767			160	AD/B + Cool	G2.5 @25,000 RPM	£83.00
OM31768			200	AD/B + Cool	G6.3 @15,000 RPM	£119.00
OM31769	DV40 FMB 32	32mm	50	AD/B + Cool	G2.5 @25,000 RPM	£41.00
OM31770			100	AD/B + Cool	G2.5 @25,000 RPM	£52.00
OM31771			160	AD/B + Cool	G2.5 @25,000 RPM	£83.00
OM31772			200	AD/B + Cool	G6.3 @15,000 RPM	£129.00
OM31773	DV40 FMB 40	40mm	60	AD/B + Cool	G2.5 @25,000 RPM	£52.00
OM31774			100	AD/B + Cool	G2.5 @25,000 RPM	£55.00
OM31775			160	AD/B + Cool	G6.3 @15,000 RPM	£109.00

OM31917	DV50 FMB 16	16mm	45	AD/B + Cool	G2.5 @25,000 RPM	£64.00
OM31918			100	AD/B + Cool	G2.5 @25,000 RPM	£72.00
OM31919			160	AD/B + Cool	G2.5 @25,000 RPM	£94.00
OM31920			200	AD/B + Cool	G2.5 @25,000 RPM	£125.00
OM31924	DV50 FMB 22	22mm	45	AD/B + Cool	G2.5 @25,000 RPM	£64.00
OM31925			100	AD/B + Cool	G2.5 @25,000 RPM	£72.00
OM31926			160	AD/B + Cool	G2.5 @25,000 RPM	£94.00
OM31927			200	AD/B + Cool	G2.5 @25,000 RPM	£125.00
OM31931	DV50 FMB 27	27mm	45	AD/B + Cool	G2.5 @25,000 RPM	£64.00
OM31932			100	AD/B + Cool	G2.5 @25,000 RPM	£72.00
OM31933			160	AD/B + Cool	G2.5 @25,000 RPM	£94.00
OM31934			200	AD/B + Cool	G2.5 @25,000 RPM	£125.00
OM31938	DV50 FMB 32	32mm	45	AD/B + Cool	G2.5 @25,000 RPM	£64.00
OM31939			100	AD/B + Cool	G2.5 @25,000 RPM	£72.00
OM31940			160	AD/B + Cool	G2.5 @25,000 RPM	£94.00
OM31941			200	AD/B + Cool	G6.3 @15,000 RPM	£176.00
OM31945	DV50 FMB 40	40mm	45	AD/B + Cool	G2.5 @25,000 RPM	£64.00
OM31946			100	AD/B + Cool	G2.5 @25,000 RPM	£72.00
OM31947			160	AD/B + Cool	G6.3 @15,000 RPM	£125.00
OM31948			200	AD/B + Cool	G6.3 @15,000 RPM	£210.00



ANTI-VIBRATION FACE MILL ARBORS DV40 & DV50

- DIN 69871
- For Mounting Face Mill Cutters
- Damped tool holders for long reach applications
- Form AD – Through Spindle Coolant

Part Number	Description	Spigot Size	Gauge Length (mm)	Balance	Price
OM33765	DV40 FMB AV 16	16mm	200	G6.3 @8,000 RPM	£159.00
OM33766			300	G6.3 @8,000 RPM	£239.00
OM33767	DV40 FMB AV 22	22mm	200	G6.3 @8,000 RPM	£159.00
OM33768			300	G6.3 @8,000 RPM	£239.00
OM33769	DV40 FMB AV 27	27mm	200	G6.3 @8,000 RPM	£159.00

OM33770	DV50 FMB AV 16	16mm	200	G6.3 @8,000 RPM	£195.00
OM33771			300	G6.3 @8,000 RPM	£269.00
OM33772			400	G6.3 @8,000 RPM	£339.00
OM33773	DV50 FMB AV 22	22mm	200	G6.3 @8,000 RPM	£195.00
OM33774			300	G6.3 @8,000 RPM	£269.00
OM33775			400	G6.3 @8,000 RPM	£339.00
OM33776	DV50 FMB AV 27	27mm	200	G6.3 @8,000 RPM	£195.00
OM33777			300	G6.3 @8,000 RPM	£269.00
OM33778			400	G6.3 @8,000 RPM	£339.00
OM33779	DV50 FMB AV 32	32mm	300	G6.3 @8,000 RPM	£269.00



COMBI SHELL MILL ARBORS DV40 & DV50

- DIN 69871
- For Mounting Face Mills & Side/Face Cutters

Part Number	Description	Spigot Size	Gauge Length (mm)	Form	Price
OM31172	DV40 COMBI 16	16mm	55	AD	£34.00
OM31171			100	AD	£46.00
OM31174	DV40 COMBI 22	22mm	55	AD	£34.00
OM31173			100	AD	£46.00
OM31176	DV40 COMBI 27	27mm	55	AD	£34.00
OM31175			100	AD	£46.00
OM31177	DV40 COMBI 32	32mm	60	AD	£34.00
OM31178	DV40 COMBI 40	40mm	60	AD	£40.00

OM31220	DV50 COMBI 16	16mm	55	AD	£59.00
OM31222	DV50 COMBI 22	22mm	55	AD	£59.00
OM31221			100	AD	£84.00
OM31225	DV50 COMBI 27	27mm	55	AD	£59.00
OM31224			100	AD	£84.00
OM31228	DV50 COMBI 32	32mm	55	AD	£59.00
OM31227			100	AD	£84.00
OM31231	DV50 COMBI 40	40mm	60	AD	£59.00
OM31229			100	AD	£84.00



MORSE TAPER ADAPTORS DV40 & DV50

- DIN 69871
- For Tools with Morse Taper Shank & Tang

Part Number	Description	Gauge Length (mm)	Form	Balance	Price
OM31202	DV40 MTA 1	50	AD	G2.5 @20,000 RPM	£29.00
OM31203	DV40 MTA 2	50	AD	G2.5 @20,000 RPM	£29.00
OM31204	DV40 MTA 3	70	AD	G2.5 @20,000 RPM	£29.00
OM31205	DV40 MTA 4	95	AD	G2.5 @20,000 RPM	£29.00

OM31240	DV50 MTA 1	60	AD	G6.3 @15,000 RPM	£54.00
OM31241	DV50 MTA 2	60	AD	G6.3 @15,000 RPM	£54.00
OM31242	DV50 MTA 3	65	AD	G6.3 @15,000 RPM	£54.00
OM31243	DV50 MTA 4	95	AD	G6.3 @15,000 RPM	£54.00
OM31244	DV50 MTA 5	105	AD	G6.3 @15,000 RPM	£59.00



MORSE TAPER ADAPTORS WITH DRAWBAR THREAD DV40

- DIN69871
- For Tools with Morse Taper & Drawbar Thread
- G6.3 @ 15,000 RPM

Part Number	Description	Gauge Length (mm)	Price
OM30273	DV40 MTB 1	45	£44.00
OM30274	DV40 MTB 2	60	£44.00
OM30275	DV40 MTB 3	80	£44.00
OM30276	DV40 MTB 4	100	£44.00



MLC SYNCHRO TAPPING CHUCKS DV40 & DV50

- DIN69871
- Minimum Length Compensation Tapping Chucks
- +/-0.5mm Compression & Expansion
- High Concentricity Enables High Speed Tapping
- Recommended for use with QCTC Type Collets
- QCTC Collets – Pg. 186
- Spares – Pg. 214

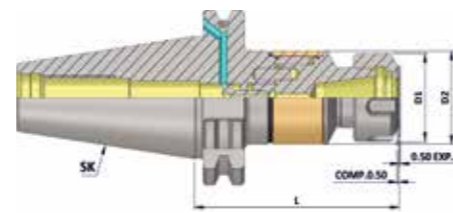

Part Number	Description	Capacity	Clamping Range (mm)	Collet Nut	Dimensions (mm)					Price
					D1	D2	L	Comp.	Exp.	
OM32439	DV40 MLC ER16	M3-M12	1-10	ER16	32	34	79	0.5	0.5	£132.00
OM32440	DV40 MLC ER20	M3-M16	3.5-10	ER20	35	34	80	0.5	0.5	£142.00
OM32441	DV40 MLC ER25	M3-M20	3.5-16	ER25	42	34	84	0.5	0.5	£142.00
OM32442	DV40 MLC ER32	M4-M27	3.5-20	ER32	50	45	95	0.5	0.5	£146.00
OM32443	DV40 MLC ER40	M6-M33	6-26	ER40	63	62	120	0.5	0.5	£153.00

OM32444	DV50 MLC ER16	M3-M12	1-10	ER16	32	34	79	0.5	0.5	£162.00
OM32445	DV50 MLC ER20	M3-M16	3.5-10	ER20	35	34	80	0.5	0.5	£174.00
OM32460	DV50 MLC ER25	M3-M20	3.5-16	ER25	42	34	84	0.5	0.5	£174.00
OM32470	DV50 MLC ER32	M4-M27	3.5-20	ER32	50	45	95	0.5	0.5	£182.00
OM32471	DV50 MLC ER40	M6-M33	6-26	ER40	63	62	105	0.5	0.5	£189.00

QUICK CHANGE TAPPING CHUCKS DV40 & DV50

- DIN 69871
- Axial Length Compensation
- With Tension & Compression
- Quick change tap adaptors available in 3 sizes
- QC Tap Adaptors – Pg. 192



Part Number	Description	Gauge Length (mm)	Tapping Range	Price
OM31379	DV40 Size 1 (TC312-59)	59	M3 - M12	£96.00
OM31380	DV40 Size 2 (TC820-97)	97	M6 - M20	£98.00
OM31381	DV40 Size 3 (TC1433-156)	156	M14 - M36	£195.00

OM31382	DV50 Size 1 (TC312-63)	63	M3 - M12	£149.00
OM31383	DV50 Size 2 (TC820-97)	97	M6 - M20	£169.00
OM31384	DV50 Size 3 (TC1433-140)	140	M14 - M36	£259.00

HEX KEY PREMIUM DRILL CHUCKS DV40 & DV50

- DIN 69871
- Premium Drill Chuck
- Strong Clamping Force in both clockwise & anti-clockwise operations
- Increased wear-resistance with Titanium Jaws
- Spare Hex Key – Pg. 217

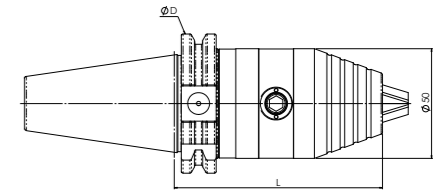

Part Number	Description	Capacity (mm)	L	D	Price
OM33662	DV40 GHK 13 90	0.3-13	90	63.55	£156.00
OM33663	DV40 GHK 16 95	1.5-16	95	63.55	£164.00

OM33664	DV50 GHK 13 90	0.3-13	90	97.5	£187.00
OM33665	DV50 GHK 16 95	1.5-16	95	97.5	£204.00

NCDC DRILL CHUCKS DV40 & DV50

- DIN 69871
- High Accuracy Drill Chuck
- Maximum Rigidity
- NCDC Spanner – Pg. 217



Part Number	Description	Dimensions (mm)				Price
		Capacity	D1	L	L1	
OM33655	DV40 NCDC 1-13mm	1-13mm	50	86	98.5	£114.00
OM33656	DV50 NCDC 1-13mm	1-13mm	50	108	120.5	£180.00

APU KEYLESS DRILL CHUCKS DV40 & DV50

- DIN 69871
- Economy drill chuck for general engineering applications
- APU Spanner – Pg. 217



Part Number	Description	Gauge Length (mm)	Capacity	Price
OM31170	DV40 APU 13 1-13mm	100	1-13mm	£83.00
OM31571	DV40 APU 16 3-16mm	120	3-16mm	£83.00

OM31218	DV50 APU 13 1-13mm	100	1-13mm	£99.00
OM31219	DV50 APU 16 3-16mm	105	3-16mm	£99.00

DRILL CHUCK ARBORS DV40 & DV50

- DIN 69871
- For Mounting Drill Chucks
- Drill Chucks – Pg. 204

Part Number	Description	Balance	Price
OM31201	DV40 JT6	G6.3 @ 12,000 RPM	£31.00
OM31448	DV40 B16	G6.3 @ 12,000 RPM	£31.00

OM31239	DV50 JT6	G6.3 @ 12,000 RPM	£52.00
OM31534	DV50 B16	G6.3 @ 12,000 RPM	£52.00



DIN 2080 TECHNICAL SPECIFICATION

- Manufactured with Casehardening Steel
- Surface Hardened HRC 60+-2
- Hardening Depth 0.8mm+0.2mm
- Taper Angle Tolerance AT3

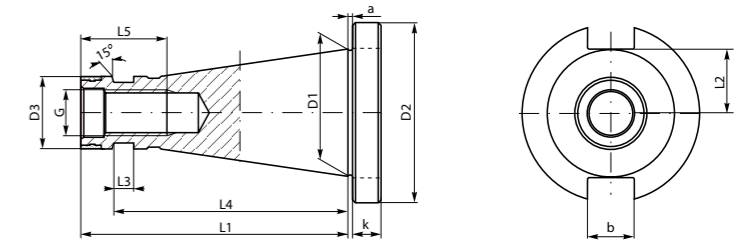

Taper	D1	a	b	k	G	D2	D3	L1	L2	L3	L4	L5
30	31.8	1.6	16.1	8	M12	50.0	17.5	68.4	16.2	-	-	24
40	44.5	1.6	16.1	10	M16	63.0	25.0	93.4	22.5	7	82	32
50	69.9	3.2	25.7	12	M24	97.5	39.2	126.8	35.3	13	115	47

TEST ARBORS DV40 & DV50

- DIN 69871
- Master Mandrel
- Supplied with protective wooden case

Part Number	Description	Diameter (mm)	Gauge Length (mm)	Price
OM33744	DV40 Test Arbor	40	300	£206.00
OM33745	DV50 Test Arbor	50	350	£345.00



MACHINABLE BORING BAR BLANKS DV40 & DV50

- DIN 69871
- machinable Boring Bar Blanks

Part Number	Description	Diameter (mm)	Gauge Length (mm)	Price
OM30293	DV40 BLANK 63 250	63	250	£82.00

OM30294	DV50 BLANK 97 315	97	315	£152.00
---------	-------------------	----	-----	---------



ER COLLET CHUCKS ISO 40 & ISO 50

- DIN2080
- Standard Nut Collet Chucks
- ER Collets – Pg. 154
- Spares – Pg. 214

Part Number	Description	Gauge Length (mm)	Form	Nut	Balance	Price
OM31258	DIN2080 40 ER16	70	AD	ER16 Hexagon (OM31426)	G6.3 @ 15,000 RPM	£29.00
OM31963		100	AD		G6.3 @ 15,000 RPM	£48.00
OM30334		160	AD		G6.3 @ 15,000 RPM	£59.00
OM30335		200	AD		G6.3 @ 15,000 RPM	£89.00
OM31259	DIN2080 40 ER25	60	AD	ER25 Castellated (OM31421)	G6.3 @ 15,000 RPM	£29.00
OM31964		100	AD		G6.3 @ 15,000 RPM	£48.00
OM30336		160	AD		G6.3 @ 15,000 RPM	£59.00
OM30337		200	AD		G6.3 @ 15,000 RPM	£89.00
OM31260	DIN2080 40 ER32	70	AD	ER32 Castellated (OM31422)	G6.3 @ 15,000 RPM	£29.00
OM31965		100	AD		G6.3 @ 15,000 RPM	£48.00
OM30338		160	AD		G6.3 @ 15,000 RPM	£59.00
OM30339		200	AD		G6.3 @ 15,000 RPM	£89.00
OM31333	DIN2080 40 ER40	80	AD	ER40 Castellated (OM31423)	G6.3 @ 15,000 RPM	£29.00
OM30340		100	AD		G6.3 @ 15,000 RPM	£48.00
OM30341		160	AD		G6.3 @ 15,000 RPM	£59.00
OM30342		200	AD		G6.3 @ 15,000 RPM	£89.00

OM31279	DIN2080 50 ER32	70	AD	ER32 Castellated (OM31422)	G6.3 @ 15,000 RPM	£61.00
OM31280	DIN2080 50 ER40	70	AD	ER40 Castellated (OM31423)	G6.3 @ 15,000 RPM	£61.00



END MILL HOLDERS ISO 40 & ISO 50

- DIN2080
- For mounting straight shank tools with weldon flat
- Spare Clamp Screws – Pg. 218

Part Number	Description	Bore Size	Gauge Length (mm)	Balance	Price
OM31270	DIN2080 40 S/L 06	6mm	50	G6.3 @ 15,000 RPM	£29.00
OM30343			100	G6.3 @ 15,000 RPM	£49.00
OM31271	DIN2080 40 S/L 08	8mm	50	G6.3 @ 15,000 RPM	£29.00
OM30344			100	G6.3 @ 15,000 RPM	£49.00
OM31272	DIN2080 40 S/L 10	10mm	63	G6.3 @ 15,000 RPM	£29.00
OM30345			100	G6.3 @ 15,000 RPM	£49.00
OM31273	DIN2080 40 S/L 12	12mm	63	G6.3 @ 15,000 RPM	£29.00
OM30346			100	G6.3 @ 15,000 RPM	£49.00
OM31274	DIN2080 40 S/L 16	16mm	63	G6.3 @ 15,000 RPM	£29.00
OM30347			100	G6.3 @ 15,000 RPM	£49.00
OM31275	DIN2080 40 S/L 20	20mm	63	G6.3 @ 15,000 RPM	£29.00
OM30348			100	G6.3 @ 15,000 RPM	£49.00
OM31276	DIN2080 40 S/L 25	25mm	90	G6.3 @ 15,000 RPM	£32.00
OM31277	DIN2080 40 S/L 32	32mm	100	G6.3 @ 15,000 RPM	£36.00
OM31278	DIN2080 40 S/L 40	40mm	90	G6.3 @ 15,000 RPM	£38.00

OM31290	DIN2080 50 S/L 16	16mm	63	G6.3 @ 15,000 RPM	£54.00
OM31291	DIN2080 50 S/L 20	20mm	63	G6.3 @ 15,000 RPM	£54.00
OM31292	DIN2080 50 S/L 25	25mm	90	G6.3 @ 15,000 RPM	£54.00
OM31293	DIN2080 50 S/L 32	32mm	100	G6.3 @ 15,000 RPM	£54.00
OM31294	DIN2080 50 S/L 40	40mm	100	G6.3 @ 15,000 RPM	£54.00



FACE MILL ARBORS ISO 40 & ISO 50

- DIN2080
- For Mounting Face Mill Cutters

Part Number	Description	Spigot Size	Gauge Length (mm)	Balance	Price
OM31261	DIN2080 40 FMB 16	16mm	45	G6.3 @ 15,000 RPM	£29.00
OM30349			100	G6.3 @ 15,000 RPM	£51.00
OM30350			160	G6.3 @ 15,000 RPM	£78.00
OM30351			200	G6.3 @ 15,000 RPM	£98.00
OM31262	DIN2080 40 FMB 22	22mm	45	G6.3 @ 15,000 RPM	£29.00
OM30352			100	G6.3 @ 15,000 RPM	£51.00
OM30353			160	G6.3 @ 15,000 RPM	£78.00
OM30354			200	G6.3 @ 15,000 RPM	£98.00
OM31263	DIN2080 40 FMB 27	27mm	45	G6.3 @ 15,000 RPM	£29.00
OM30355			100	G6.3 @ 15,000 RPM	£51.00
OM30356			160	G6.3 @ 15,000 RPM	£78.00
OM30357			200	G6.3 @ 15,000 RPM	£98.00
OM31264	DIN2080 40 FMB 32	32mm	60	G6.3 @ 15,000 RPM	£29.00
OM30358			100	G6.3 @ 15,000 RPM	£51.00
OM30359			160	G6.3 @ 15,000 RPM	£83.00
OM30360			200	G6.3 @ 15,000 RPM	£110.00
OM31984	DIN2080 40 FMB 40	40mm	60	G6.3 @ 15,000 RPM	£34.00
OM30361			100	G6.3 @ 15,000 RPM	£58.00
OM30362			160	G6.3 @ 15,000 RPM	£88.00
OM30363			200	G6.3 @ 15,000 RPM	£114.00

OM31281	DIN2080 50 FMB 22	22mm	45	G6.3 @ 15,000 RPM	£54.00
OM31282	DIN2080 50 FMB 27	27mm	45	G6.3 @ 15,000 RPM	£54.00
OM31283	DIN2080 50 FMB 32	32mm	60	G6.3 @ 15,000 RPM	£54.00
OM31284	DIN2080 50 FMB 40	40mm	60	G6.3 @ 15,000 RPM	£54.00



DIN 2080

DIN 2080

MORSE TAPER ADAPTORS ISO 40 & ISO 50

- DIN 2080
- For Tools with Morse Taper Shank & Tang

Part Number	Description	Gauge Length (mm)	Balance	Price
OM31266	DIN2080 40 MTA 1	45	G6.3 @ 15,000 RPM	£29.00
OM31267	DIN2080 40 MTA 2	60	G6.3 @ 15,000 RPM	£29.00
OM31268	DIN2080 40 MTA 3	60	G6.3 @ 15,000 RPM	£29.00
OM31269	DIN2080 40 MTA 4	95	G6.3 @ 15,000 RPM	£29.00

OM31286	DIN2080 50 MTA 2	45	G6.3 @ 15,000 RPM	£54.00
OM31287	DIN2080 50 MTA 3	60	G6.3 @ 15,000 RPM	£54.00
OM31288	DIN2080 50 MTA 4	90	G6.3 @ 15,000 RPM	£54.00
OM31289	DIN2080 50 MTA 5	105	G6.3 @ 15,000 RPM	£56.00



NCDC DRILL CHUCKS ISO 40 & ISO 50

- DIN 2080
- High Accuracy Drill Chuck, <0.05mm
- Maximum Rigidity
- NCDC Spanner – Pg. 217

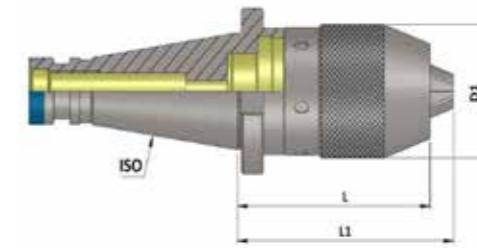

Part Number	Description	Dimensions (mm)				Price
		Capacity	D1	L	L1	
OM31546	DIN2080 40 NCDC 1-13mm	1-13mm	50	88.5	101	£115.00
OM31547	DIN2080 50 NCDC 1-13mm	1-13mm	50	88.5	101	£179.00

APU KEYLESS DRILL CHUCKS ISO 40 & ISO 50

- DIN 2080
- Keyless drill chuck can be tightened with wrench
- APU Spanner – Pg. 217

Part Number	Description	Gauge Length (mm)	Balance	Price
OM31358	DIN2080 40 APU13 1-13mm	100	G6.3 @ 15,000RPM	£83.00
OM31359	DIN2080 50 APU16 1-16mm	105	G6.3 @ 15,000RPM	£99.00



QUICK CHANGE TAPPING CHUCKS ISO 40 & ISO 50

- DIN 2080
- Axial Length Compensation
- With Tension & Compression
- Quick change tap adaptors available in 3 sizes
- QC Tap Adaptors – Pg. 192

Part Number	Description	Gauge Length (mm)	Tapping Range	Price
OM31373	DIN2080 40 Size 1 (TC312-55)	55	M3 - M12	£96.00
OM31374	DIN2080 40 Size 2 (TC820-86)	86	M6 - M20	£98.00
OM31375	DIN2080 40 Size 3 (TC1433-132)	132	M14 - M36	£195.00

OM31376	DIN2080 50 Size 1 (TC312-62)	62	M3 - M12	£149.00
OM31377	DIN2080 50 Size 2 (TC820-90)	90	M6 - M20	£169.00
OM31378	DIN2080 50 Size 3 (TC1433-117)	117	M14 - M36	£259.00



DRILL CHUCK ARBORS ISO 40 & ISO 50

- DIN 2080
- For Mounting Drill Chucks
- Drill Chucks – Pg. 204

Part Number	Description	Gauge Length (mm)	Balance	Price
OM31265	DIN2080 40 JT6	45	G6.3 @ 15,000RPM	£29.00
OM31985	DIN2080 40 B16	45	G6.3 @ 15,000RPM	£29.00
OM31285	DIN2080 50 JT6	45	G6.3 @ 15,000RPM	£51.00
OM31986	DIN2080 50 B16	45	G6.3 @ 15,000RPM	£51.00



MACHINABLE BORING BAR BLANKS ISO 40 & ISO 50

- DIN 2080

Part Number	Description	Diameter (mm)	Gauge Length (mm)	Price
OM31049	DIN2080 40 BLANK 63 250	63	250	£82.00
OM31055	DIN2080 50 BLANK 97 315	97	315	£154.00



HSK63A

HSK63A (DIN69893 A+C) TECHNICAL SPECIFICATION

- Manufactured with Casehardening Steel
- Surface Hardened HRC 60+2
- Hardening Depth 0.8mm+0.2mm

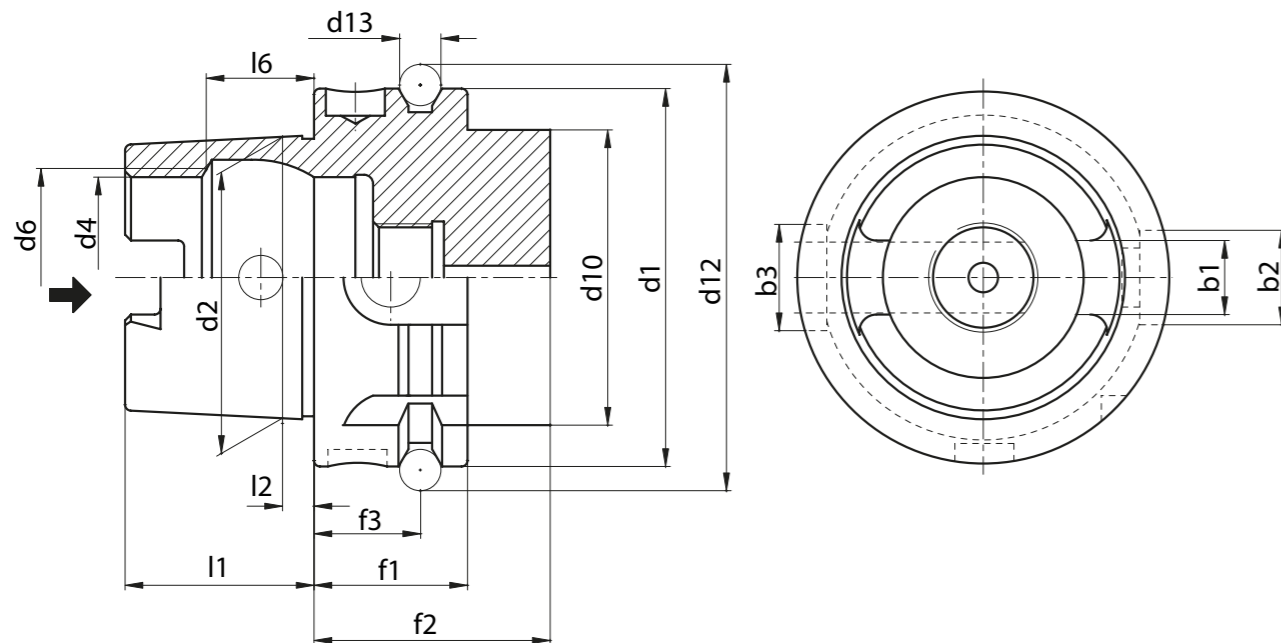

	HSK 32	HSK 40	HSK 50	HSK 63	HSK 100	HSK 125
b1	7.05	8.05	10.54	12.54	20.02	25.02
b2	7	9	12.0	16	20.00	25.0
b3	9	11	14.0	18	22.00	28.0
d1	32	40	50	63	100	125
d2	24	30	38	48	75	95
d4	17	21	26	34	53	67
d6	19	23	29	37	58	73
d10	26	34	42	53	88	111
d12	37	45	59.3	72.3	109.75	134.75
d13	4	4	7	7	7	7
f1	20	20	26	26	29	29
f2	35	35	42	42	45	45
f3	16	16	18	18	20	20
l1	16	20	25	32	50	63
l2	3.2	4	5	6.3	10	12.5
l6	8.92	11.42	14.13	18.13	28.56	36.27

ER MINI COLLET CHUCKS HSK63A

- HSK63A (DIN 69893)
- MINI Nut ER Collet Chucks
- Slimline Extended Mini Chucks
- ER Collets – Pg. 154
- Spares – Pg. 214

Part Number	Description	Gauge Length (mm)	Nut	Balance	Price
OM30364	HSK63A ER11 MINI	100	ER11 Mini (OM31414)	G2.5 @ 25,000 RPM	£80.00
OM30796		160		G2.5 @ 25,000 RPM	£124.00
OM30396	HSK63A ER16 MINI	100	ER16 Mini (OM31415)	G2.5 @ 25,000 RPM	£80.00
OM31996		160		G2.5 @ 25,000 RPM	£124.00



ER COLLET CHUCKS HSK63A

- HSK63A (DIN 69893)
- Standard Nut Collet Chucks
- ER Collets – Pg. 154
- Spares – Pg. 214

Part Number	Description	Gauge Length (mm)	Nut	Balance	Price
OM31500	HSK63A ER16	75	ER16 Hexagon (OM31426)	G2.5 @ 25,000 RPM	£66.00
OM31501		100		G2.5 @ 25,000 RPM	£70.00
OM31987		160		G2.5 @ 25,000 RPM	£119.00
OM30374		200		G2.5 @ 25,000 RPM	£146.00
OM31502	HSK63A ER25	75	ER25 Castellated (OM31421)	G2.5 @ 25,000 RPM	£66.00
OM31503		100		G2.5 @ 25,000 RPM	£70.00
OM31988		160		G2.5 @ 25,000 RPM	£119.00
OM30375		200		G2.5 @ 25,000 RPM	£146.00
OM31504	HSK63A ER32	75	ER32 Castellated (OM31422)	G2.5 @ 25,000 RPM	£66.00
OM31505		100		G2.5 @ 25,000 RPM	£70.00
OM31989		160		G2.5 @ 25,000 RPM	£119.00
OM30376		200		G2.5 @ 25,000 RPM	£146.00
OM30278	HSK63A ER40	80	ER40 Castellated (OM31423)	G2.5 @ 25,000 RPM	£72.00



DIE & MOULD COLLET CHUCKS HSK63A

- HSK63A (DIN69893)
- Drawback Collet Style
- Ultra Precision DMC Slim Collet Chucks
- High Accuracy <0.005mm
- Balanced to G2.5 @ 25,000 RPM
- DMC Collets – Pg. 184
- Hex Keys – Pg. 217

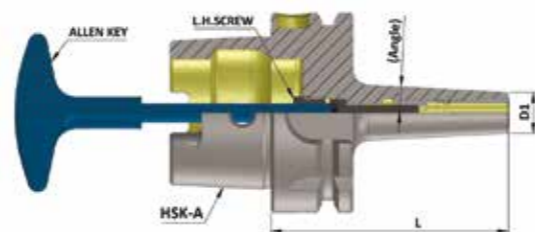

Part Number	Description	Dimensions (mm)			Angle	Collet	Screw	Allen Key	Price
		Clamping Range	D1	L					
OM32367	HSK63A DMC 06	3-6	13	75	3°	DMC 06	M5	4X200	£94.00
OM32368		3-6	13	95	3°	DMC 06	M5	4X200	£94.00
OM32369		3-6	13	120	3°	DMC 06	M5	4X200	£98.00
OM32370		3-6	13	160	3°	DMC 06	M5	4X200	£119.00
OM32371	HSK63A DMC 08	3-8	22	100	3°	DMC 08	M6	5X200	£98.00
OM32372		3-8	22	160	3°	DMC 08	M6	5X200	£119.00
OM32373	HSK63A DMC 10	3-10	28	110	3°	DMC 10	M8	6X200	£98.00



SHRINK FIT HOLDERS HSK63A

- HSK63A (DIN 69893)
- Superior Clamping Strength & Rigidity
- Form AD/B
- 4.5 Degree
- Balanced G2.5 @ 25,000RPM

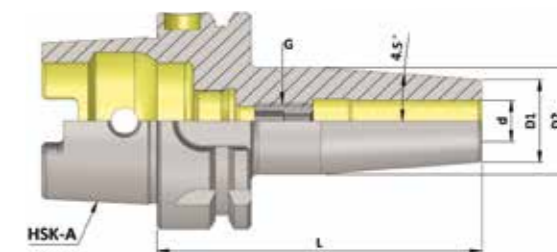

Part Number	Description	Dimensions (mm)					Price
		d	D1	D2	G	L	
OM30901	HSK63A SF 03	3mm	10	20	-	80	£112.00
OM30902			10	20	-	120	£135.00
OM30903			10	20	-	160	£156.00
OM30848	HSK63A SF 04	4mm	15	22	-	80	£112.00
OM30904			15	22	-	120	£135.00
OM30905			15	22	-	160	£156.00
OM30906	HSK63A SF 05	5mm	15	22	-	80	£112.00
OM30907			15	22	-	120	£135.00
OM30908			15	22	-	160	£156.00
OM30849	HSK63A SF 06	6mm	21	27	M5	80	£89.00
OM30850			21	27	M5	120	£109.00
OM30851			21	27	M5	160	£139.00
OM30852	HSK63A SF 08	8mm	21	27	M6	80	£89.00
OM30853			21	27	M6	120	£109.00
OM30854			21	27	M6	160	£139.00
OM30855	HSK63A SF 10	10mm	24	31	M8	85	£89.00
OM30856			24	31	M8	120	£109.00
OM30857			24	31	M8	160	£139.00
OM30858	HSK63A SF 12	12mm	24	31	M10	90	£89.00
OM30859			24	31	M10	120	£109.00
OM30860			24	31	M10	160	£139.00
OM30909	HSK63A SF 14	14mm	27	34	M10	90	£89.00
OM30910			27	34	M10	120	£109.00
OM30911			27	34	M10	160	£139.00
OM30861	HSK63A SF 16	16mm	27	34	M12	95	£89.00
OM30862			27	34	M12	120	£109.00
OM30863			27	34	M12	160	£139.00
OM30912	HSK63A SF 18	18mm	33	40	M12	95	£89.00
OM30913			33	40	M12	120	£109.00
OM30914			33	40	M12	160	£139.00
OM30864	HSK63A SF 20	20mm	33	40	M16	100	£89.00
OM30865			33	40	M16	120	£109.00
OM30866			33	40	M16	160	£139.00
OM30867	HSK63A SF 25	25mm	44	44	M16	115	£89.00
OM30868			44	44	M16	160	£139.00
OM30869	HSK63A SF 32	32mm	44	44	M16	120	£109.00
OM30870			44	44	M16	160	£139.00



HYDRAULIC EXPANSION CHUCKS HSK63A

- HSK63A (DIN69893)
- Ultra Precision Hydraulic Chucks
- High Accuracy <0.005mm
- Balanced to G2.5 @ 25,000 RPM
- Spares – Pg. 216

Figure 1

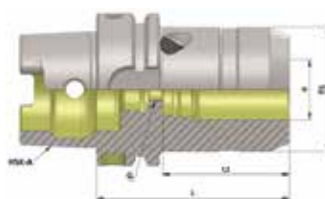
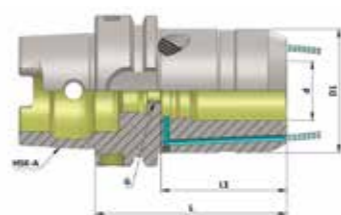

Figure 2



Part Number	Description	Dimensions (mm)					Fig.	Price
		d	D1	G	L	L1		
OM32206	HSK63A HC12S	12	42	M10	80	40	Fig. 1	£169.00
OM32208		12	42	M10	80	40	Fig. 2	£228.00
OM32207	HSK63A HC20S	20	50	M16	80	42	Fig. 1	£169.00
OM32209		20	50	M16	80	42	Fig. 2	£228.00

MILLING CUTTER ARBORS HSK63A

- HSK63A (DIN69893)
- Arbors for Screw Type Modular Milling Cutters
- Balanced to G2.5 @ 25,000RPM

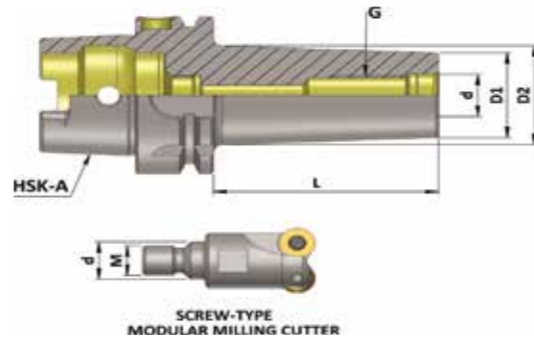

SCREW-TYPE
MODULAR MILLING CUTTER



Part Number	Description	Dimensions (mm)					Price
		d	D1	D2	G	L	
OM30984	HSK63A MCA 06	6.5	10	13	M6	25	£118.00
OM30985	HSK63A MCA 08	8.5	13	15	M8	25	£118.00
OM30986		8.5	13	23		50	£128.00
OM30987		8.5	13	23		75	£139.00
OM30988		8.5	13	23		100	£152.00
OM30989	HSK63A MCA 10	10.5	18	20	M10	25	£118.00
OM30990		10.5	18	23		50	£128.00
OM30991		10.5	18	28		75	£139.00
OM30992		10.5	18	32		100	£152.00
OM30993	HSK63A MCA 12	10.5	18	36.5	M12	150	£182.00
OM30994		12.5	21	24		25	£118.00
OM30995		12.5	21	24		50	£128.00
OM30996		12.5	21	31		75	£139.00
OM30997	HSK63A MCA 16	12.5	21	33	M16	100	£152.00
OM30998		12.5	21	40		150	£182.00
OM30776		17	29	29		25	£118.00
OM30777	HSK63A MCA 16	17	29	34	M16	50	£128.00
OM30778		17	29	34		75	£139.00
OM30779		17	29	36		100	£152.00
OM30780		17	29	42.5		150	£182.00

END MILL HOLDERS HSK63A

- HSK63A (DIN 69893)
- For mounting straight shank tools with weldon flat
- Balanced G6.3 @ 20,000 RPM



Part Number	Description	Bore Size	Gauge Length (mm)	Price
OM30751	HSK63A S/L 06	6mm	65	£66.00
OM30753			100	£81.00
OM30755			160	£98.00
OM30752	HSK63A S/L 08	8mm	65	£66.00
OM30754			100	£81.00
OM30756			160	£98.00
OM31506	HSK63A S/L 10	10mm	65	£66.00
OM31991			100	£82.00
OM30377	HSK63A S/L 12	12mm	160	£98.00
OM31507			80	£66.00
OM31992			100	£82.00
OM30378	HSK63A S/L 16	16mm	160	£98.00
OM31508			80	£66.00
OM31993			100	£82.00
OM30379	HSK63A S/L 20	20mm	160	£98.00
OM31509			80	£66.00
OM31994			100	£82.00
OM30380	HSK63A S/L 25	25mm	160	£98.00
OM31510			110	£71.00
OM30381	HSK63A S/L 32	32mm	160	£104.00
OM31995			110	£75.00
OM30382			160	£109.00
OM30365	HSK63A S/L 40	40mm	125	£79.00
OM30383			160	£119.00

POWER MILLING CHUCKS HSK63A

- HSK63A (DIN69893)
- High Accuracy <0.005mm
- Power Milling Chucks are subjected to sub-zero treatment (-90° C). This helps prevent any deformation, increasing tool life
- Balanced G6.3 @ 20,000 RPM
- Straight Collets – Pg. 185
- Spares – Pg. 217

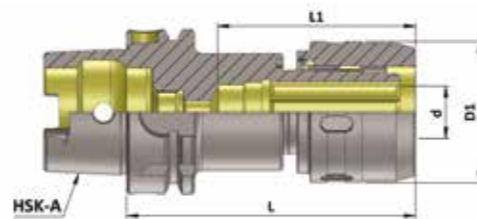

Part Number	Description	Dimensions (mm)				Price
		d	D1	L	L1	
OM31196	HSK63A UPMC 20	20	54	105	70	£186.00
OM31197	HSK63A UPMC 32	32	72	130	100	£206.00

STANDARD FACE MILL HOLDERS HSK63A

- HSK63A (DIN 69893)
- For Mounting Face Mill Cutters
- Balanced G2.5 @ 20,000 RPM

Part Number	Description	Spigot Size	Gauge Length (mm)	Price
OM31511	HSK63A FMB 16	16mm	50	£71.00
OM30384			100	£98.00
OM30385			160	£119.00
OM31512	HSK63A FMB 22	22mm	50	£71.00
OM30386			100	£85.00
OM30387			160	£119.00
OM31513	HSK63A FMB 27	27mm	60	£71.00
OM30388			100	£85.00
OM30389			160	£119.00
OM31514	HSK63A FMB 32	32mm	60	£71.00
OM30390			100	£109.00
OM30391			160	£135.00
OM30392	HSK63A FMB 40	40mm	60	£69.00
OM30393			100	£119.00
OM30394			160	£142.00



ANTI-VIBRATION FACE MILL ARBORS HSK63A

- HSK63A (DIN 69893)
- For Mounting Face Mill Cutters
- With Front Face Coolant Channels
- Damped tool holders for long reach applications

Part Number	Description	Spigot Size	Gauge Length (mm)	Price
OM33780	HSK63A FMB AV 16	16mm	200	£219.00
OM33781			300	£279.00
OM33782	HSK63A FMB AV 22	22mm	200	£219.00
OM33783			300	£279.00
OM33784	HSK63A FMB AV 27	27mm	200	£219.00



THROUGH COOLANT FACE MILL ARBORS HSK63A (DIN 69893)

- For Mounting Face Mill Cutters
- With Front Face Coolant Channels
- Balanced G2.5 @ 20,000 RPM

Part Number	Description	Spigot Size	Gauge Length (mm)	Price
OM34482	HSK63A FMB 16	16mm	45	£71.00
OM34483			100	£98.00
OM34484			160	£119.00
OM34485	HSK63A FMB 22	22mm	50	£71.00
OM34486			100	£85.00
OM34487			160	£119.00
OM34488	HSK63A FMB 27	27mm	55	£71.00
OM34489			100	£85.00
OM34490			160	£119.00
OM34491	HSK63A FMB 32	32mm	60	£71.00
OM34492			100	£109.00
OM34493			160	£135.00



MORSE TAPER ADAPTORS HSK63A

- HSK63A (DIN 69893)
- For Tools with Morse Taper Shank & Tang
- Balanced G6.3 @ 20,000 RPM

Part Number	Description	D1	L	Price
OM33495	HSK63A MTA 1	25	100	£78.00
OM33496	HSK63A MTA 2	32	115	£78.00
OM33497	HSK63A MTA 3	40	135	£80.00
OM33498	HSK63A MTA 4	48	160	£84.00

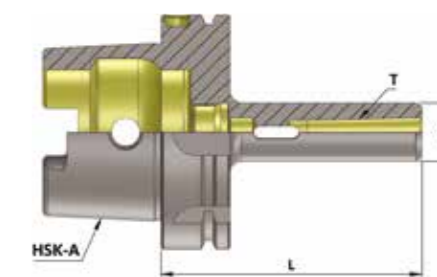

MLC SYNCHRO TAPPING CHUCKS HSK63A

- HSK63A (DIN69893)
- Minimum Length Compensation Tapping Chucks
- +/-0.5mm Compression & Expansion
- High Concentricity Enables High Speed Tapping
- Recommended for use with QCTC Type Collets
- QCTC Collets – Pg. 186
- Spares – Pg. 214

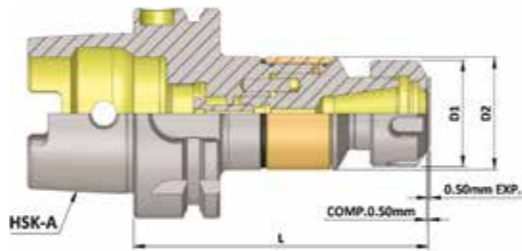

Part Number	Description	Capacity	Clamping Range (mm)	Collet Nut	Dimensions (mm)					Price
					D1	D2	L	Comp.	Exp.	
OM32472	HSK63A ER16 MLC	M3-M12	1-10	ER16	32	34	89	0.5	0.5	£216.00
OM32473	HSK63A ER20 MLC	M3-M16	3.5-10	ER20	35	34	90	0.5	0.5	£225.00
OM32474	HSK63A ER25 MLC	M3-M20	3.5-16	ER25	42	34	94	0.5	0.5	£225.00
OM32475	HSK63A ER32 MLC	M4-M27	3.5-20	ER32	50	45	105	0.5	0.5	£234.00
OM32476	HSK63A ER40 MLC	M6-M33	6-26	ER40	63	62	133.5	0.5	0.5	£242.00

HEX KEY PREMIUM DRILL CHUCKS HSK63A

- Premium Drill Chuck
- Strong Clamping Force in both clockwise & anti-clockwise operations
- Increased wear-resistance with Titanium Jaws
- Spare Hex Key – Pg. 217

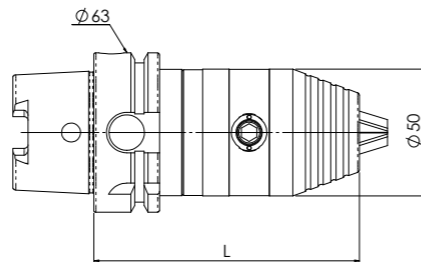

Part Number	Description	Capacity (mm)	L	Price
OM33666	HSK63A GHK 13-105	0.3-13	105	£219.00
OM33667	HSK63A GHK 16-110	1.5-16	110	£248.00

NCDC DRILL CHUCKS HSK63A

- HSK63A (DIN 69893)
- High Accuracy Drill Chuck, <0.05mm
- NCDC Spanner – Pg. 217

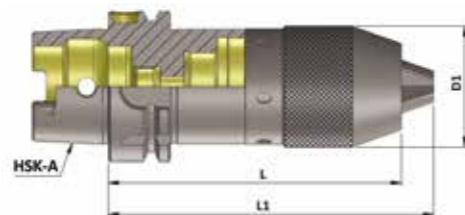

Part Number	Description	Dimensions (mm)				Price
		Capacity	D1	L	L1	
OM33657	HSK63A NCDC 1-13mm	1-13mm	50	122.5	135	£186.00

TEST ARBORS HSK63A

- HSK63A (DIN 69893)
- Master Mandrel

Part Number	Description	Diameter (mm)	Gauge Length (mm)	Price
OM33747	HSK63A Test Arbor	40	300	£285.00



MACHINEABLE BORING BAR BLANK HSK63A

- HSK63A (DIN 69893)
- Machinable Boring Bar Blank

Part Number	Description	Diameter (mm)	Gauge Length (mm)	Price
OM34683	HSK63A BLANK 63 250	63	250	£149.00
OM34684	HSK63A BLANK 80 250	80	250	£149.00



HSK63F

HSK63F (DIN69893F) TECHNICAL SPECIFICATION

	HSK 50	HSK 63
d1	50	63
d2	30	38
d4	42	53
d6	59.3	72.3
d7	7	7
d8	21	26
d10	23	29
f1	26	26
f2	42	42
f3	18	18
l1	20	25
l2	4	5
l4	11.42	14.13

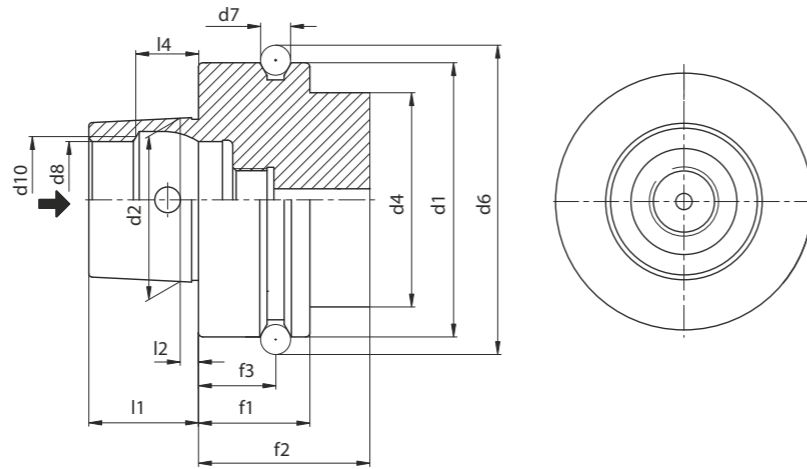

ER COLLET CHUCKS HSK63F

- HSK63F (DIN 69893F)
- Standard Nut Collet Chucks
- ER Collets – Pg. 154
- Spares – Pg. 214

Part Number	Description	Gauge Length (mm)	Nut	Balance	Price
OM31974	HSK63F ER16	70	ER16 Hexagon (OM31426)	G2.5 @ 25,000 RPM	£89.00
OM31515		100		G2.5 @ 25,000 RPM	£92.00
OM31516		160		G2.5 @ 25,000 RPM	£125.00
OM31975	HSK63F ER25	75	ER25 Castellated (OM31421)	G2.5 @ 25,000 RPM	£89.00
OM31519		100		G2.5 @ 25,000 RPM	£92.00
OM31520		160		G2.5 @ 25,000 RPM	£125.00
OM31976	HSK63F ER32	75	ER32 Castellated (OM31422)	G2.5 @ 25,000 RPM	£89.00
OM31521		100		G2.5 @ 25,000 RPM	£92.00
OM31522		160		G2.5 @ 25,000 RPM	£125.00



THROUGH COOLANT FACE MILL ARBORS HSK63F

- HSK63F (DIN 69893F)
- For Mounting Face Mill Cutters
- With Front Face Coolant Channels
- Balanced G2.5 @ 25,000 RPM

Part Number	Description	Spigot Size (mm)	Gauge Length (mm)	Price
OM34691	HSK63F FMB K16	16	45	£97.00
OM34692	HSK63F FMB K22	22	50	£97.00
OM34693	HSK63F FMB K27	27	55	£97.00



HSK63F

HSK63F

VDI (DIN69880)

VDI (DIN69880) TECHNICAL SPECIFICATION

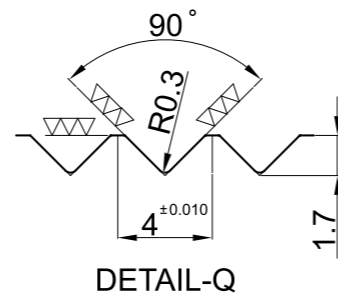
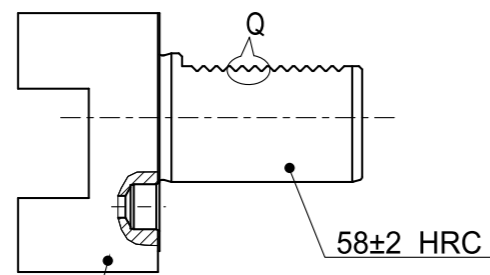
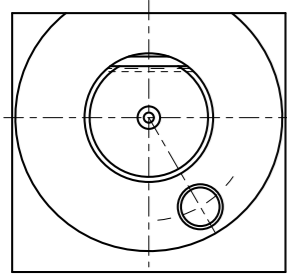

20±2 HRC (TOUGHENED STEEL)
40±2 HRC (CASE HARDENED STEEL)

- VDI tool holders are manufactured to DIN69880 standard
- Form A, B, C, D, E1, E2 & Z holders are manufactured with toughened steel C-45
- Form E4 & F holders are manufactured with case hardened steel 20MnCr5
- All standard tool holders are fully blackened
- Tool holder shanks are heat treated to 58HRC and the teeth ground

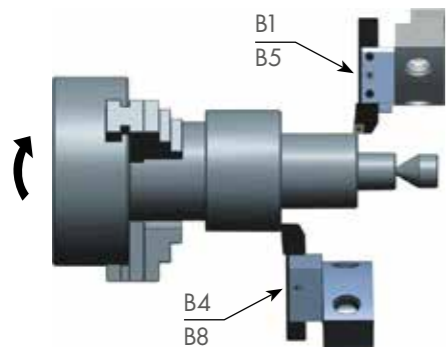

Spindle Rotation - Clockwise application of OD Turn & Face

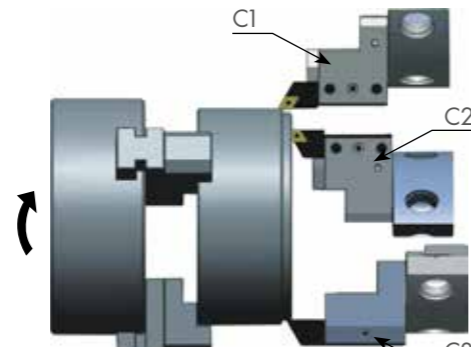

Spindle Rotation - Clockwise application of Face & ID Bore

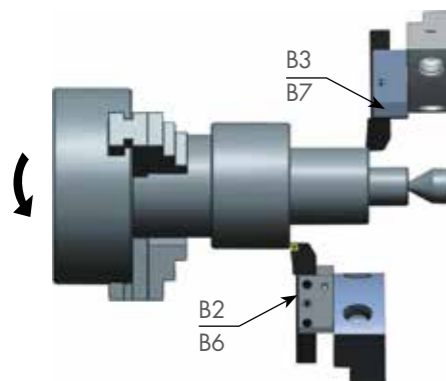

Spindle Rotation - Anticlockwise application of OD Turn & Face

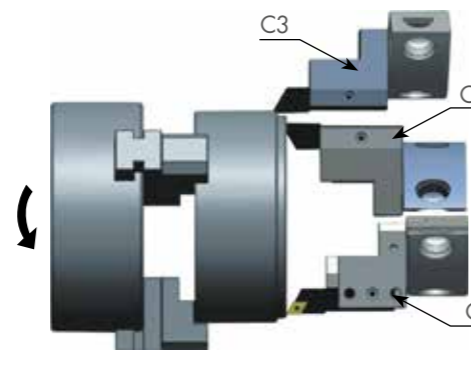

Spindle Rotation - Anticlockwise application of Face & ID Bore

VDI A1 MACHINABLE TOOL BLANK

- VDI - DIN 69880 (ISO 10889)
- Rectangular Form

Part Number	Description	Dimensions (mm)				Price
		d1	a	b	h	
OM33298	VDI16 A1 - 44 x 78 x 44	16	78	44	44	£68.00
OM33210	VDI20 A1 - 65 x 100 x 60	20	100	65	60	£67.00
OM33299	VDI25 A1 - 75 x 100 x 60	25	100	75	60	£89.00
OM33211	VDI30 A1 - 85 x 130 x 60	30	130	85	60	£90.00
OM33212	VDI40 A1 - 100 x 151 x 96	40	151	100	96	£133.00
OM33213	VDI50 A1 - 125 x 160 x 120	50	160	125	120	£203.00
OM33300	VDI60 A1 - 160 x 165 x 125	60	165	160	125	£254.00

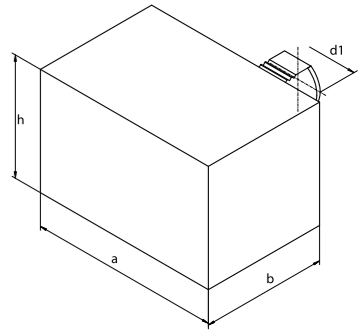

VDI A2 MACHINABLE TOOL BLANK

- VDI - DIN 69880 (ISO 10889)
- Cylindrical Form

Part Number	Description	Dimensions (mm)			Price
		d1	b	d2	
OM33301	VDI16 A2 - 40 x 60	16	60	40	£58.00
OM33214	VDI20 A2 - 50 x 70	20	70	50	£57.00
OM33302	VDI25 A2 - 58 x 80	25	80	58	£58.00
OM33215	VDI30 A2 - 68 x 100	30	100	68	£65.00
OM33216	VDI40 A2 - 83 x 120	40	120	83	£75.00
OM33217	VDI50 A2 - 98 x 135	50	135	98	£90.00
OM33303	VDI60 A2 - 123 x 150	60	150	123	£138.00

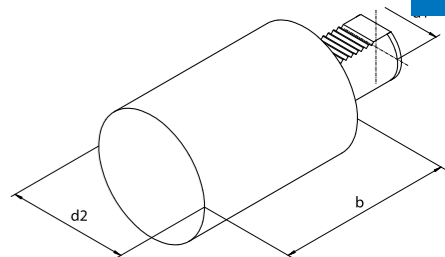

VDI B1 RADIAL HOLDERS, RIGHT HAND, SHORT

- VDI - DIN 69880 (ISO 10889)
- For Square Shank Tools

Part Number	Description	Dimensions (mm)					Price
		d1	a	b	h1	h2	
OM33304	VDI16 B1 - 12 x 24	16	24	42	12	10	£57.00
OM33100	VDI20 B1 - 16 x 30	20	30	55	16	12	£57.00
OM33305	VDI25 B1 - 16 x 30	25	30	55	16	12	£57.00
OM33101	VDI30 B1 - 20 x 40	30	40	70	20	16	£57.00
OM33102	VDI40 B1 - 25 x 44	40	44	85	25	20	£60.00
OM33103	VDI50 B1 - 32 x 55	50	55	100	32	25	£97.00
OM33306	VDI60 B1 - 32 x 60	60	60	125	32	25	£149.00

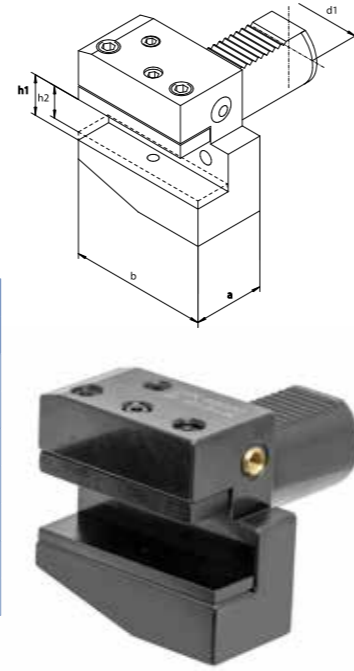

VDI B3 RADIAL OVERHEAD HOLDERS, RIGHT HAND, SHORT

- VDI - DIN 69880 (ISO 10889)
- For Square Shank Tools

Part Number	Description	Dimensions (mm)					Price
		d1	a	b	h1	h2	
OM33310	VDI16 B3 - 12 x 24	16	24	42	12	10	£57.00
OM33108	VDI20 B3 - 16 x 30	20	30	55	16	12	£57.00
OM33311	VDI25 B3 - 16 x 30	25	30	55	16	12	£57.00
OM33109	VDI30 B3 - 20 x 40	30	40	70	20	16	£57.00
OM33110	VDI40 B3 - 25 x 44	40	44	85	25	20	£60.00
OM33111	VDI50 B3 - 32 x 55	50	55	100	32	25	£97.00
OM33312	VDI60 B3 - 32 x 60	60	60	125	32	25	£149.00

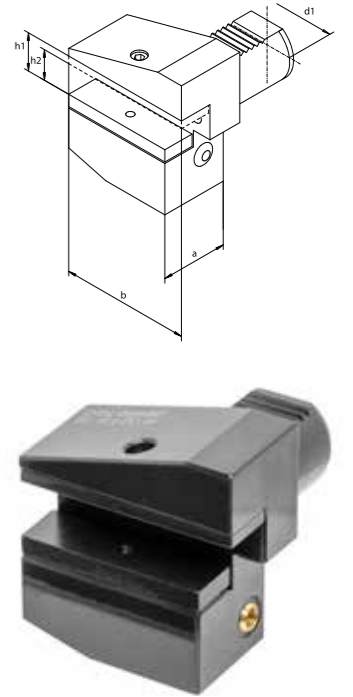

VDI B2 RADIAL HOLDERS, LEFT HAND, SHORT

- VDI - DIN 69880 (ISO 10889)
- For Square Shank Tools

Part Number	Description	Dimensions (mm)					Price
		d1	a	b	h1	h2	
OM33307	VDI16 B2 - 12 x 24	16	24	42	12	10	£57.00
OM33104	VDI20 B2 - 16 x 30	20	30	55	16	12	£57.00
OM33308	VDI25 B2 - 16 x 30	25	30	55	16	12	£57.00
OM33105	VDI30 B2 - 20 x 40	30	40	70	20	16	£57.00
OM33106	VDI40 B2 - 25 x 44	40	44	85	25	20	£60.00
OM33107	VDI50 B2 - 32 x 55	50	55	100	32	25	£97.00
OM33309	VDI60 B2 - 32 x 60	60	60	125	32	25	£149.00

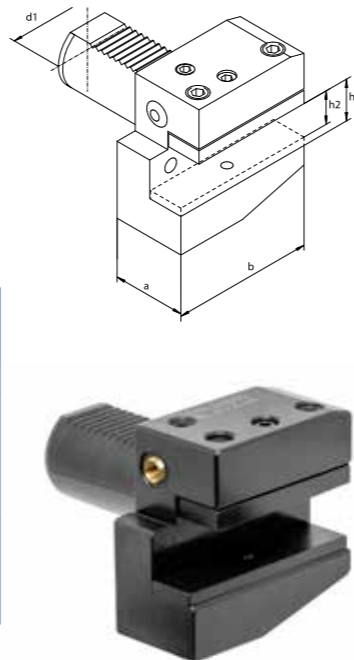

VDI B4 RADIAL OVERHEAD HOLDERS, LEFT HAND, SHORT

- VDI - DIN 69880 (ISO 10889)
- For Square Shank Tools

Part Number	Description	Dimensions (mm)					Price
		d1	a	b	h1	h2	
OM33313	VDI16 B4 - 12 x 24	16	24	42	12	10	£57.00
OM33112	VDI20 B4 - 16 x 30	20	30	55	16	12	£57.00
OM33314	VDI25 B4 - 16 x 30	25	30	55	16	12	£57.00
OM33113	VDI30 B4 - 20 x 40	30	40	70	20	16	£57.00
OM33114	VDI40 B4 - 25 x 44	40	44	85	25	20	£60.00
OM33115	VDI50 B4 - 32 x 55	50	55	100	32	25	£97.00
OM33315	VDI60 B4 - 32 x 60	60	60	125	32	25	£149.00

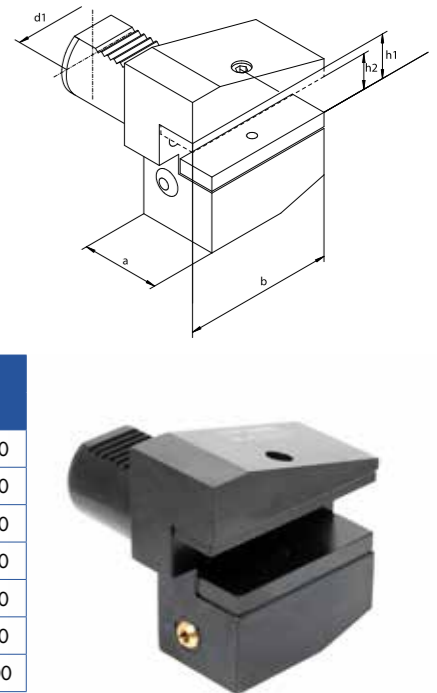

VDI B5 RADIAL HOLDERS, RIGHT HAND HAND, LONG

- VDI - DIN 69880 (ISO 10889)
- For Square Shank Tools

Part Number	Description	Dimensions (mm)					Price
		d1	a	b	h1	h2	
OM33316	VDI16 B5 - 12 x 24	16	24	58	12	10	£112.00
OM33116	VDI20 B5 - 16 x 30	20	30	75	16	12	£112.00
OM33317	VDI25 B5 - 16 x 30	25	30	75	16	12	£124.00
OM33117	VDI30 B5 - 20 x 40	30	40	100	20	16	£123.00
OM33118	VDI40 B5 - 25 x 44	40	44	118	25	20	£130.00
OM33119	VDI50 B5 - 32 x 55	50	55	130	32	25	£170.00
OM33318	VDI60 B5 - 32 x 60	60	60	145	32	25	£235.00

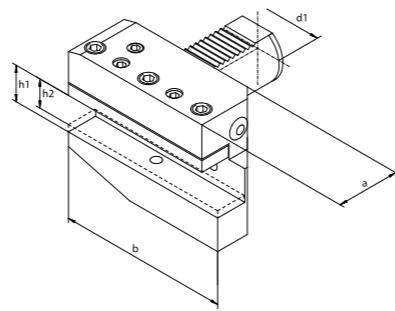

VDI B7 RADIAL OVERHEAD HOLDERS, RIGHT HAND HAND, LONG

- VDI - DIN 69880 (ISO 10889)
- For Square Shank Tools

Part Number	Description	Dimensions (mm)					Price
		d1	a	b	h1	h2	
OM33322	VDI16 B7 - 12 x 24	16	24	58	12	10	£112.00
OM33124	VDI20 B7 - 16 x 30	20	30	75	16	12	£112.00
OM33323	VDI25 B7 - 16 x 30	25	30	75	16	12	£124.00
OM33125	VDI30 B7 - 20 x 40	30	40	100	20	16	£123.00
OM33126	VDI40 B7 - 25 x 44	40	44	118	25	20	£130.00
OM33127	VDI50 B7 - 32 x 55	50	55	130	32	25	£170.00
OM33324	VDI60 B7 - 32 x 60	60	60	145	32	25	£235.00

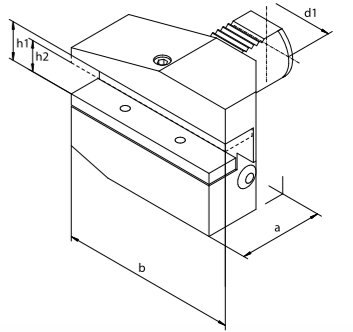

VDI B6 RADIAL HOLDERS, LEFT HAND HAND, LONG

- VDI - DIN 69880 (ISO 10889)
- For Square Shank Tools

Part Number	Description	Dimensions (mm)					Price
		d1	a	b	h1	h2	
OM33319	VDI16 B6 - 12 x 24	16	24	58	12	10	£112.00
OM33120	VDI20 B6 - 16 x 30	20	30	75	16	12	£112.00
OM33320	VDI25 B6 - 16 x 30	25	30	75	16	12	£124.00
OM33121	VDI30 B6 - 20 x 40	30	40	100	20	16	£123.00
OM33122	VDI40 B6 - 25 x 44	40	44	118	25	20	£130.00
OM33123	VDI50 B6 - 32 x 55	50	55	130	32	25	£170.00
OM33321	VDI60 B6 - 32 x 60	60	60	145	32	25	£235.00

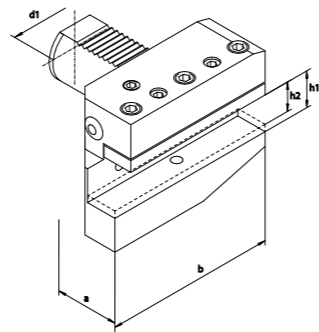

VDI B8 RADIAL OVERHEAD HOLDERS, LEFT HAND HAND, LONG

- VDI - DIN 69880 (ISO 10889)
- For Square Shank Tools

Part Number	Description	Dimensions (mm)					Price
		d1	a	b	h1	h2	
OM33325	VDI16 B8 - 12 x 24	16	24	58	12	10	£112.00
OM33128	VDI20 B8 - 16 x 30	20	30	75	16	12	£112.00
OM33326	VDI25 B8 - 16 x 30	25	30	75	16	12	£124.00
OM33129	VDI30 B8 - 20 x 40	30	40	100	20	16	£123.00
OM33130	VDI40 B8 - 25 x 44	40	44	118	25	20	£130.00
OM33131	VDI50 B8 - 32 x 55	50	55	130	32	25	£170.00
OM33327	VDI60 B8 - 32 x 60	60	60	145	32	25	£235.00

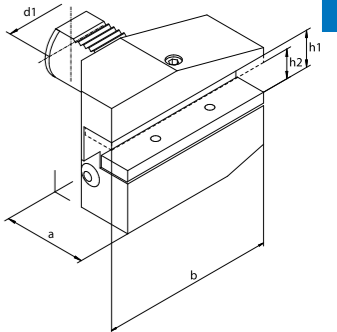

VDI (DIN69880)

VDI (DIN69880)

VDI C1 AXIAL HOLDERS, RIGHT HAND

- VDI - DIN 69880 (ISO 10889)
- For Square Shank Tools

Part Number	Description	Dimensions (mm)					Price
		d1	a	b	h1	h2	
OM33328	VDI16 C1 - 12 x 44	16	43	44	12	10	£65.00
OM33132	VDI20 C1 - 16 x 55	20	52	55	16	12	£65.00
OM33329	VDI25 C1 - 16 x 55	25	58	55	16	12	£65.00
OM33133	VDI30 C1 - 20 x 70	30	70	70	20	16	£67.00
OM33134	VDI40 C1 - 25 x 85	40	85	85	25	20	£77.00
OM33135	VDI50 C1 - 32 x 100	50	100	100	32	25	£105.00
OM33330	VDI60 C1 - 32 x 125	60	125	125	32	25	£194.00

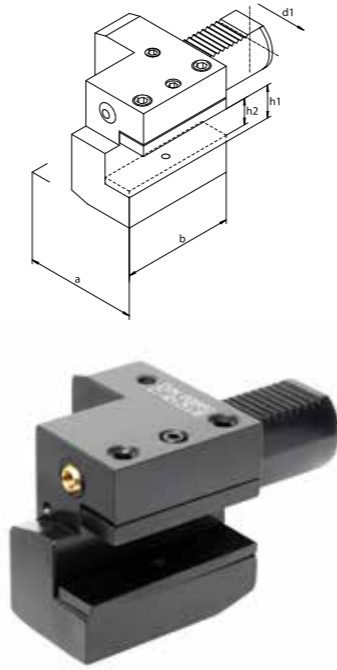

VDI C3 AXIAL OVERHEAD HOLDERS, RIGHT HAND

- VDI - DIN 69880 (ISO 10889)
- For Square Shank Tools

Part Number	Description	Dimensions (mm)					Price
		d1	a	b	h1	h2	
OM33334	VDI16 C3 - 12 x 44	16	43	44	12	10	£65.00
OM33140	VDI20 C3 - 16 x 55	20	52	55	16	12	£65.00
OM33335	VDI25 C3 - 16 x 55	25	58	55	16	12	£65.00
OM33141	VDI30 C3 - 20 x 70	30	70	70	20	16	£67.00
OM33142	VDI40 C3 - 25 x 85	40	85	85	25	20	£77.00
OM33143	VDI50 C3 - 32 x 100	50	100	100	32	25	£105.00
OM33336	VDI60 C3 - 32 x 125	60	125	125	32	25	£194.00

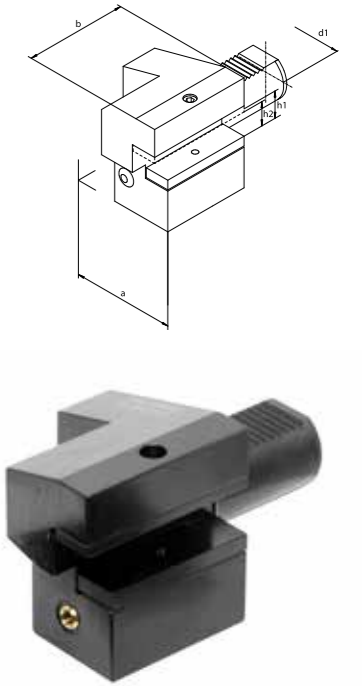

VDI C2 AXIAL HOLDERS, LEFT HAND

- VDI - DIN 69880 (ISO 10889)
- For Square Shank Tools

Part Number	Description	Dimensions (mm)					Price
		d1	a	b	h1	h2	
OM33331	VDI16 C2 - 12 x 44	16	43	44	12	10	£65.00
OM33136	VDI20 C2 - 16 x 55	20	57	55	16	12	£65.00
OM33332	VDI25 C2 - 16 x 55	25	58	55	16	12	£65.00
OM33137	VDI30 C2 - 20 x 70	30	76	70	20	16	£67.00
OM33138	VDI40 C2 - 25 x 85	40	90	85	25	20	£77.00
OM33139	VDI50 C2 - 32 x 100	50	105	100	32	25	£105.00
OM33333	VDI60 C2 - 32 x 125	60	125	125	32	25	£194.00

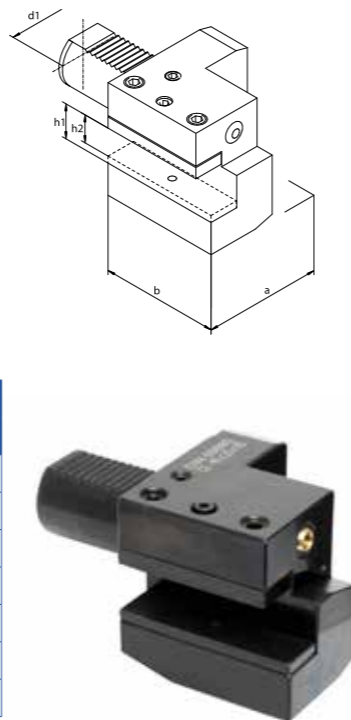

VDI C4 AXIAL OVERHEAD HOLDERS, LEFT HAND

- VDI - DIN 69880 (ISO 10889)
- For Square Shank Tools

Part Number	Description	Dimensions (mm)					Price
		d1	a	b	h1	h2	
OM33337	VDI16 C4 - 12 x 44	16	43	44	12	10	£65.00
OM33144	VDI20 C4 - 16 x 55	20	57	55	16	12	£65.00
OM33338	VDI25 C4 - 16 x 55	25	58	55	16	12	£65.00
OM33145	VDI30 C4 - 20 x 70	30	76	70	20	16	£67.00
OM33146	VDI40 C4 - 25 x 85	40	90	85	25	20	£77.00
OM33147	VDI50 C4 - 32 x 100	50	105	100	32	25	£105.00
OM33339	VDI60 C4 - 32 x 125	60	125	125	32	25	£194.00

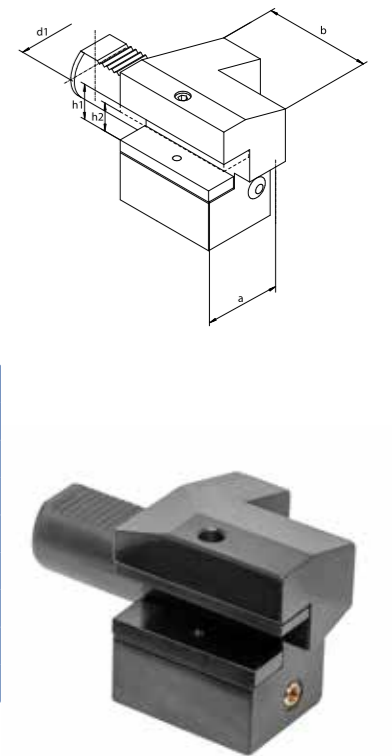

VDI D1 MULTIPLE SQUARE SEAT HOLDERS

- VDI - DIN 69880 (ISO 10889)

Part Number	Description	Dimensions (mm)							Price
		d1	a	b	h1	h2	h3	h4	
OM33340	VDI25 D1 - 16 x 48	25	66	48	16	12	25	30	£159.00
OM33240	VDI30 D1 - 20 x 60	30	76	60	20	16	28	38	£160.00
OM33241	VDI40 D1 - 25 x 72	40	90	72	25	20	32.5	48	£192.00
OM33242	VDI50 D1 - 32 x 85	50	105	85	32	25	35	60	£216.00
OM33341	VDI60 D1 - 32 x 110	60	115	110	32	25	42.5	62.5	£235.00

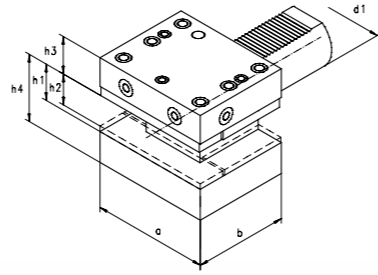

VDI E1 INDEXABLE DRILL HOLDER

- VDI - DIN 69880 (ISO 10889)
- For Clamping Indexable Drills

Part Number	Description	Dimensions (mm)				Price
		d1	d2	d6	b	
OM33148	VDI20 E1	20	20	40	67	£62.00
OM33149			25	45	71	£62.00
OM33344	VDI25 E1	25	20	40	67	£63.00
OM33345			25	45	71	£63.00
OM33150	VDI30 E1	30	20	40	67	£60.00
OM33151			25	45	71	£60.00
OM33152			32	52	75	£60.00
OM33153	VDI40 E1	40	20	40	67	£68.00
OM33154			25	45	75	£68.00
OM33155			32	52	75	£68.00
OM33156			40	65	90	£68.00
OM33157	VDI50 E1	50	20	40	67	£84.00
OM33158			25	45	80	£84.00
OM33159			32	52	80	£84.00
OM33160			40	65	90	£84.00
OM33161			50	75	100	£84.00
OM33346	VDI60 E1	60	20	40	80	£126.00
OM33347			25	45	80	£126.00
OM33348			32	52	80	£126.00
OM33349			40	65	90	£126.00
OM33350			50	75	100	£126.00

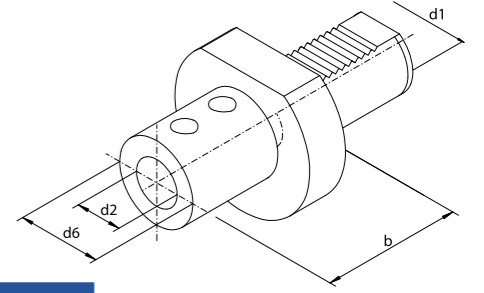

VDI D2 MULTIPLE SQUARE SEAT HOLDERS

- VDI - DIN 69880 (ISO 10889)

Part Number	Description	Dimensions (mm)							Price
		d1	a	b	h1	h2	h3	h4	
OM33342	VDI25 D2 - 16 x 48	25	66	48	16	12	30	25	£159.00
OM33243	VDI30 D2 - 20 x 60	30	76	60	20	16	38	35	£160.00
OM33244	VDI40 D2 - 25 x 72	40	90	72	25	20	48	42.5	£192.00
OM33245	VDI50 D2 - 32 x 85	50	105	85	32	25	60	50	£216.00
OM33343	VDI60 D2 - 32 x 110	60	115	110	32	25	62.5	62.5	£235.00

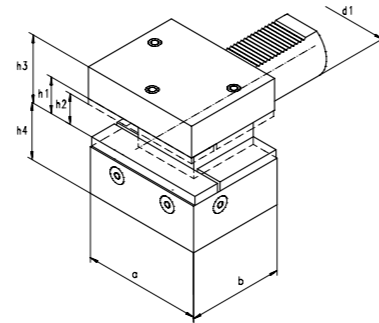

VDI E2 BORING BAR HOLDER

- VDI - DIN 69880 (ISO 10889)
- For clamping Boring Bars

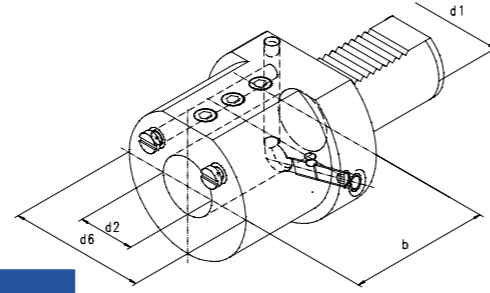

Part Number	Description	Dimensions (mm)				Price
		d1	d2	d6	b	
OM33351	VDI16 E2	16	6	40	44	£59.00
OM33352			8	40	44	£59.00
OM33353			10	40	44	£59.00
OM33354			12	40	44	£59.00
OM33355			16	40	44	£59.00
OM33162	VDI20 E2	20	8	40	50	£57.00
OM33163			10	40	50	£57.00
OM33164			12	40	50	£57.00
OM33165			16	40	50	£57.00
OM33166			20	50	50	£57.00
OM33167		25	50	60	£57.00	
OM33356	VDI25 E2	25	8	40	50	£63.00
OM33357			10	40	50	£63.00
OM33358			12	40	50	£63.00
OM33359			16	40	50	£63.00
OM33360			20	58	50	£63.00
OM33361		25	58	60	£63.00	
OM33168	VDI30 E2	30	8	55	60	£59.00
OM33169			10	55	60	£59.00
OM33170			12	55	60	£59.00
OM33171			16	55	60	£59.00
OM33172			20	55	60	£59.00
OM33173			25	55	60	£59.00
OM33174		32	68	75	£59.00	
OM33175	VDI40 E2	40	8	55	75	£62.00
OM33176			10	55	75	£62.00
OM33177			12	55	75	£62.00
OM33178			16	55	75	£62.00
OM33179			20	55	75	£62.00
OM33180			25	55	75	£62.00
OM33181		32	83	75	£62.00	
OM33182		40	83	90	£62.00	
OM33183	VDI50 E2	50	12	68	90	£79.00
OM33184			16	68	90	£79.00
OM33185			20	68	90	£79.00
OM33186			25	68	90	£79.00
OM33187			32	68	90	£79.00
OM33188			40	98	90	£79.00
OM33189		50	98	100	£79.00	
OM33362	VDI60 E2	60	16	68	90	£129.00
OM33363			20	68	90	£129.00
OM33364			25	68	90	£129.00
OM33365			32	68	90	£129.00
OM33366			40	98	90	£129.00
OM33367		50	98	100	£129.00	

VDI E4 ER COLLET CHUCKS

- VDI - DIN 69880 (ISO 10889)
- Standard ER Collet System

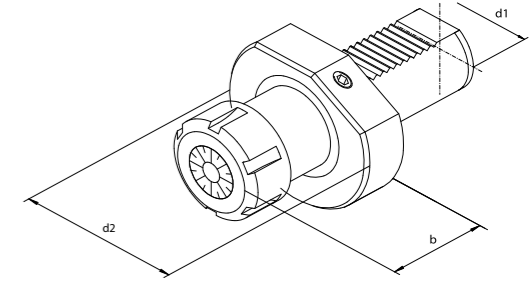

Part Number	Description	Collet Size	Dimensions (mm)			Price
			d1	d2	b	
OM33368	VDI16 E4	ER16	16	40	34.5	£83.00
OM33369		ER20		40	44	£83.00
OM33429	VDI20 E4	ER16	20	50	44	£83.00
OM33190		ER25		50	44	£83.00
OM33191		ER32		50	50	£83.00
OM33370	VDI25 E4	ER20	25	58	44	£83.00
OM33371		ER25		58	57	£83.00
OM33372		ER32		58	62	£83.00
OM33192	VDI30 E4	ER25	30	68	57	£83.00
OM33193		ER32		68	62.5	£83.00
OM33194		ER40		68	70	£83.00
OM33430	VDI40 E4	ER25	40	83	62	£91.00
OM33195		ER32		83	62	£91.00
OM33196		ER40		83	75	£91.00
OM33431	VDI50 E4	ER32	50	98	75	£136.00
OM33197		ER40		98	75	£136.00
OM33373	VDI60 E4	ER32	60	123	75	£149.00
OM33374		ER40		123	75	£149.00

ISO 10889 (DIN 69880)

ISO 10889 (DIN 69880)

VDI E7 DOUBLE BORING BAR HOLDER, RIGHT HAND

- VDI - DIN 69880 (ISO 10889)

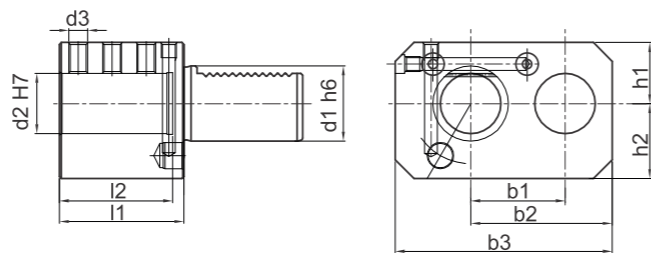

Part Number	Description	Dimensions (mm)										Price
		d1	d2	h1	h2	l1	l2	b1	b2	b3	d3	
OM33218	VDI20 E7	20	16	25	25	45	42	32	51	76	M8	£172.00
OM33219			20	25	25	45	42	32	51	76	M8	£172.00
OM33220	VDI30 E7	30	25	28	32	56	52	45	65	95	M8	£196.00
OM33221			32	28	32	66	60	50	75	110	M8	£196.00
OM33222	VDI40 E7	40	32	32.5	40	66	60	50	75	115	M10	£230.00
OM33223			40	32.5	40	90	80	50	75	115	M10	£230.00
OM33224	VDI50 E7	50	32	32.5	47.5	66	60	50	75	115	M12	£330.00
OM33225			40	32.5	47.5	90	80	50	75	115	M12	£330.00
OM33226			50	35	49	115	100	68	103	154	M12	£330.00

VDI F1 MORSE TAPER SHANK ADAPTOR

- VDI - DIN 69880 (ISO 10889)
- For Tools with Morse Taper Shank

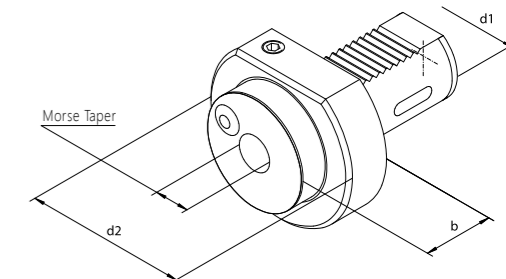

Part Number	Description	Morse Taper	Dimensions (mm)			Price
			d1	d2	b	
OM33375	VDI16 F1	1	16	40	50	£71.00
OM33376		2		40	87	£71.00
OM33198	VDI20 F1	1	20	50	23	£71.00
OM33377		2		50	61	£71.00
OM33378	VDI25 F1	1	25	58	23	£71.00
OM33379		2		58	27	£71.00
OM33199	VDI30 F1	1	30	68	27	£76.00
OM33200		2		68	27	£76.00
OM33380	VDI40 F1	3	40	68	73	£76.00
OM33381		1		83	36	£83.00
OM33201		2		83	36	£83.00
OM33202	VDI50 F1	3	50	83	36	£83.00
OM33203		4		83	80	£83.00
OM33382	VDI60 F1	1	60	98	36	£103.00
OM33204		2		98	36	£103.00
OM33205		3		98	36	£103.00
OM33206	VDI50 F1	4	50	98	50	£103.00
OM33383		5		98	169	£143.00
OM33384	VDI60 F1	2	60	123	36	£148.00
OM33385		3		123	36	£148.00
OM33386		4		123	50	£148.00
OM33387		5		123	63	£148.00

VDI E8 DOUBLE BORING BAR HOLDER, LEFT HAND

- VDI - DIN 69880 (ISO 10889)

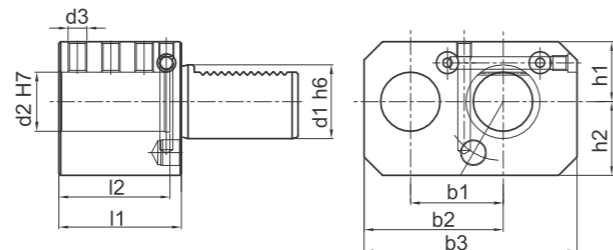

Part Number	Description	Dimensions (mm)										Price
		d1	d2	h1	h2	l1	l2	b1	b2	b3	d3	
OM33227	VDI20 E8	20	16	25	25	45	42	32	51	76	M8	£174.00
OM33228			20	25	25	45	42	32	51	76	M8	£174.00
OM33229	VDI30 E8	30	25	28	32	56	52	50	65	95	M8	£196.00
OM33230			32	28	32	66	60	50	75	110	M8	£196.00
OM33231	VDI40 E8	40	32	32.5	40	66	60	50	75	115	M10	£230.00
OM33232			40	32.5	40	90	80	50	75	115	M10	£230.00
OM33233	VDI50 E8	50	32	32.5	47.5	66	60	50	75	115	M12	£330.00
OM33234			40	32.5	47.5	90	80	50	75	115	M12	£330.00
OM33235			50	35	49	115	100	68	103	152	M12	£330.00

VDI AR PART OFF BLADE TOOLHOLDER

- VDI - DIN 69880 (ISO 10889)
- Right Hand

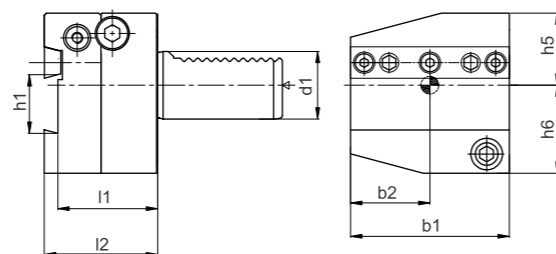

Part Number	Description	Dimensions (mm)								Price
		d1	b1	b2	h1	h5	h6	l1	l2	
OM33392	VDI20 AR 20 x 26	20	60	30	26	28	36	44	50	£197.00
OM33393	VDI25 AR 25 x 26	25	60	30	26	28	36	44	50	£210.00
OM33394	VDI30 AR 30 x 26	30	70	35	26	32	39	44	50	£228.00
OM33395	VDI30 AR 30 x 32	30	70	35	32	32	39	44	50	£228.00
OM33396	VDI40 AR 40 x 26	40	85	42.5	26	43	41.5	44	50	£270.00
OM33397	VDI40 AR 40 x 32	40	85	42.5	32	43	41.5	44	50	£270.00
OM33398	VDI50 AR 50 x 26	50	100	50	26	43	45	44	50	£392.00
OM33399	VDI50 AR 50 x 32	50	100	50	32	43	45	44	50	£392.00
OM33400	VDI60 AR 60 x 32	60	125	62.5	32	48	55	44	50	£730.00

VDI ARU PART OFF BLADE TOOLHOLDER

- VDI - DIN 69880 (ISO 10889)
- Right Hand, Upside Down

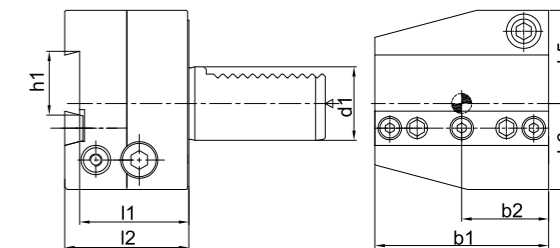

Part Number	Description	Dimensions (mm)								Price
		d1	b1	b2	h1	h5	h6	l1	l2	
OM33410	VDI20 ARU 20 x 26	20	50	30	26	36	28	44	50	£197.00
OM33411	VDI25 ARU 25 x 26	25	60	30	26	36	28	44	50	£210.00
OM33412	VDI30 ARU 30 x 26	30	70	35	26	38	35	44	50	£228.00
OM33413	VDI30 ARU 30 x 32	30	70	35	32	38	35	44	50	£228.00
OM33414	VDI40 ARU 40 x 26	40	85	42.5	26	43	41.5	44	50	£270.00
OM33415	VDI40 ARU 40 x 32	40	85	42.5	32	43	41.5	44	50	£270.00
OM33416	VDI50 ARU 50 x 26	50	100	50	26	43	45	44	50	£392.00
OM33417	VDI50 ARU 50 x 32	50	100	50	32	43	45	44	50	£392.00
OM33418	VDI60 ARU 60 x 32	60	125	62.5	32	48	55	44	50	£730.00

VDI AL PART OFF BLADE TOOLHOLDER

- VDI - DIN 69880 (ISO 10889)
- Left Hand

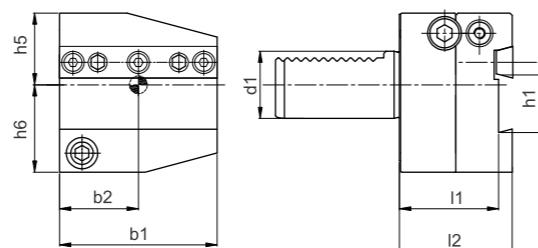

Part Number	Description	Dimensions (mm)								Price
		d1	b1	b2	h1	h5	h6	l1	l2	
OM33401	VDI20 AL 20 x 26	20	60	30	26	28	36	44	50	£197.00
OM33402	VDI25 AL 25 x 26	25	60	30	26	28	36	44	50	£210.00
OM33403	VDI30 AL 30 x 26	30	70	35	26	32	39	44	50	£228.00
OM33404	VDI30 AL 30 x 32	30	70	35	32	32	39	44	50	£228.00
OM33405	VDI40 AL 40 x 26	40	85	42.5	26	43	41.5	44	50	£270.00
OM33406	VDI40 AL 40 x 32	40	85	42.5	32	43	41.5	44	50	£270.00
OM33407	VDI50 AL 50 x 26	50	100	50	26	43	45	44	50	£392.00
OM33408	VDI50 AL 50 x 32	50	100	50	32	43	45	44	50	£392.00
OM33409	VDI60 AL 60 x 32	60	125	62.5	32	48	55	44	50	£730.00

VDI ALU PART OFF BLADE TOOLHOLDER

- VDI - DIN 69880 (ISO 10889)
- Left Hand, Upside Down

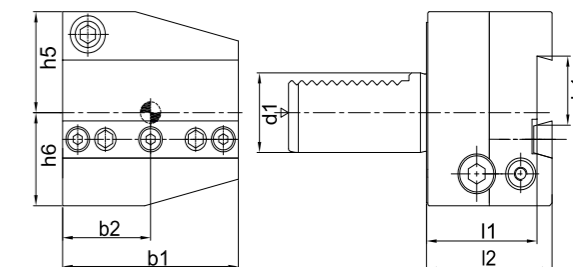

Part Number	Description	Dimensions (mm)								Price
		d1	b1	b2	h1	h5	h6	l1	l2	
OM33419	VDI20 ALU 20 x 26	20	50	30	26	36	28	44	50	£197.00
OM33420	VDI25 ALU 25 x 26	25	60	30	26	36	28	44	50	£210.00
OM33421	VDI30 ALU 30 x 26	30	70	35	26	38	35	44	50	£228.00
OM33422	VDI30 ALU 30 x 32	30	70	35	32	38	35	44	50	£228.00
OM33423	VDI40 ALU 40 x 26	40	85	42.5	26	43	41.5	44	50	£270.00
OM33424	VDI40 ALU 40 x 32	40	85	42.5	32	43	41.5	44	50	£270.00
OM33425	VDI50 ALU 50 x 26	50	100	50	26	43	45	44	50	£392.00
OM33426	VDI50 ALU 50 x 32	50	100	50	32	43	45	44	50	£392.00
OM33427	VDI60 ALU 60 x 32	60	125	62.5	32	48	55	44	50	£730.00

ISO 10889 (DIN 69880)

ISO 10889 (DIN 69880)

VDI HC HYDRAULIC EXPANSION CHUCK

- VDI - DIN 69880 (ISO 10889)
- Ultra Precision Hydraulic Chucks
- High Accuracy <0.003mm
- Spares – Pg. 216

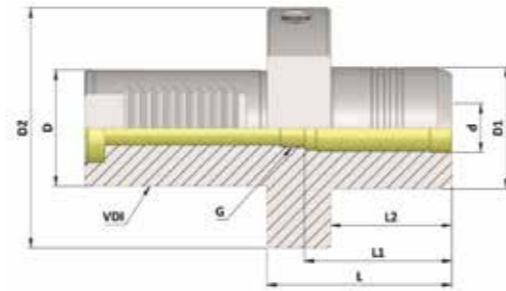

Part Number	Description	Dimensions (mm)										Price
		VDI	d	D	D1	D2	G	L	L1	L2		
OM32210	VDI30 HC20	30	20	30	42	68	M16	64	51	42	£209.00	
OM32211	VDI40 HC20	40	20	40	42	83	M20	64	51	42	£209.00	
OM32212	VDI30 HC32	30	32	30	64	68	-	86	-	64	£209.00	
OM32213	VDI40 HC32	40	32	40	64	83	-	86	-	64	£209.00	



BAR PULLER VDI & CYLINDRICAL SHANK

- Spring Tensioned Bar Puller
- Supplied with both Short & Long Jaws
- C = Cylindrical Shank

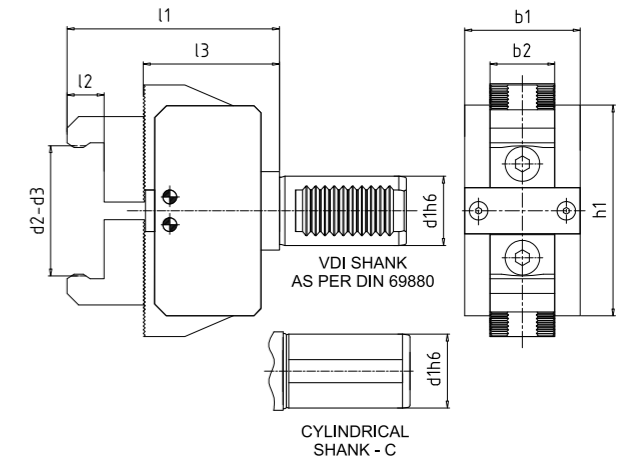

Part Number	Description	d1	Range		Dimensions (mm)						Price
			d2-d3 Short Jaws	d2-d3 Long Jaws	b1	b2	h1	l1	l2	l3	
OM34032	VDI25 BP25	25	8-60	54-110	50	28	72	84	16	51	£295.00
OM34036	C25 BP25	25	8-60	54-110	50	28	72	84	16	51	£275.00
OM34033	VDI30 BP30	30	8-60	54-110	50	28	72	92	16	59	£295.00
OM34037	C32 BP30	32	8-60	54-110	50	28	72	92	16	59	£275.00
OM34034	VDI40 BP40	40	8-66	54-110	60	28	110	94	16	61	£345.00
OM34038	C40 BP40	40	8-66	54-110	60	28	110	94	16	61	£325.00
OM34035	VDI50 BP50	50	8-75	60-125	65	28	130	114	16	81	£395.00
OM34039	C50 BP50	50	8-75	60-125	65	28	130	114	16	81	£375.00



VDI DC HEX KEY DRILL CHUCK

- VDI - DIN 69880 (ISO 10889)
- High Accuracy Premium Drill Chuck
- Strong Clamping Force
- Increased wear-resistance with Titanium Jaws
- Spare Hex Key – Pg. 217

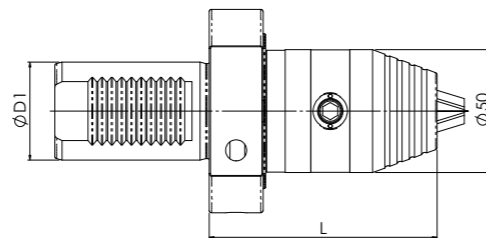
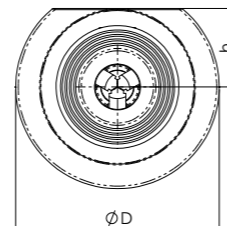

Part Number	Description	Capacity (mm)	Dimensions (mm)				Price
			L	D	h	D1	
OM33668	VDI30 GHK 13 93	0.3-13	93	68	28	30	£229.00
OM33669	VDI40 GHK 13 93	0.3-13	93	83	32	40	£248.00



VDI Z2 STEEL & PLASTIC PROTECTION PLUGS

- VDI - DIN 69880 (ISO 10889)

Part Number	VDI (d1)	Material	Price
OM33388	VDI16 Z2	Steel	£28.00
OM33246	VDI20 Z2		£28.00
OM33389	VDI 25 Z2		£28.00
OM33247	VDI30 Z2		£32.00
OM33248	VDI40 Z2		£40.00
OM33249	VDI50 Z2		£46.00
OM33390	VDI60 Z2		£75.00
OM33391	VDI25 Z2	Plastic	£12.00
OM33250	VDI30 Z2		£12.00
OM33251	VDI40 Z2		£12.00
OM33252	VDI50 Z2		£18.00



VDI Shim Plates

Part Number	Specification	Shim Plate Suits	Price
OM32016	SP20-54x13x4	VDI20 B1-B4 C1-C4	£8.50
OM32017	SP25-54x13x4	VDI25 B1-B4 C1-C4	£8.50
OM32028	SP30-69x17x4	VDI30 B1-B4 C1-C4	£9.50
OM32043	SP40-84x21x5	VDI40 B1-B4 C1-C4	£9.50
OM32044	SP50-99x24x7	VDI50 B1-B4 C1-C4	£11.50
OM32045	SP60-124x29x7	VDI60 B1-B4 C1-C4	£13.50
OM32097	SP20-74x13x4	VDI20 B5-B8	£9.50
OM32098	SP25-74x13x4	VDI25 B5-B8	£9.50
OM32099	SP30-99x17x4	VDI30 B5-B8	£13.50
OM32100	SP40-117x21x5	VDI40 B5-B8	£15.00
OM32101	SP50-129x24x7	VDI50 B5-B8	£16.00
OM32102	SP60-144x29x7	VDI60 B5-B8	£18.00



VDI SPARES

VDI Clamp Plates

Part Number	Specification	Clamp Plate Suits	Price
OM32009	CP16-36x10x4	VDI16 B1-B4, C1-C4	£8.50
OM32010	CP20-47x13x5	VDI20 B1-B4, C1-C4	£8.50
OM32011	CP25-47x13x5	VDI25 B1-B4, C1-C4	£8.50
OM32012	CP30-59x17x8	VDI30 B1-B4, C1-C4	£9.50
OM32013	CP40-71.5x21x8	VDI40 B1-B4, C1-C4	£9.50
OM32014	CP50-83x24x8	VDI50 B1-B4, C1-C4	£11.50
OM32015	CP60-108x29x8	VDI60 B1-B4, C1-C4	£13.50
OM32070	CP16-52x10x4	VDI16 B5-B8	£8.50
OM32091	CP20-67x13x5	VDI20 B5-B8	£9.50
OM32092	CP25-67x13x5	VDI25 B5-B8	£9.50
OM32093	CP30-89x17x8	VDI30 B5-B8	£11.50
OM32094	CP40-104.5x21x8	VDI40 B5-B8	£13.50
OM32095	CP50-113x24x8	VDI50 B5-B8	£15.00
OM32096	CP60-128x29x8	VDI60 B5-B8	£16.00



VDI Coolant Nozzles

Part Number	Specification	Coolant Nozzle Suits	Price
OM32046	MB10xM4	VDI16	£8.50
OM32047	MB12xM5	VDI20/25/30	£9.50
OM32048	MB14xM6	VDI40/50/60	£10.50



VDI O-Rings

Part Number	Specification	O-Ring Suits	Price
OM32049	ZSRS-15x1.5	VDI16	£7.00
OM32050	ZSRS-18.77x1.78	VDI20	£8.00
OM32051	ZSRS-23.52x1.78	VDI25	£8.00
OM32052	ZSRS-28.30x1.78	VDI30	£9.00
OM32053	ZSRS-37.77x2.62	VDI40	£10.00
OM32054	ZSRS-47.29x2.62	VDI50	£11.00
OM32055	ZSRS-56.74x3.53	VDI60	£13.00



VDI ATH Axial Tool Head - Square

- DIN 5482
- VDI Driven Tool Holders

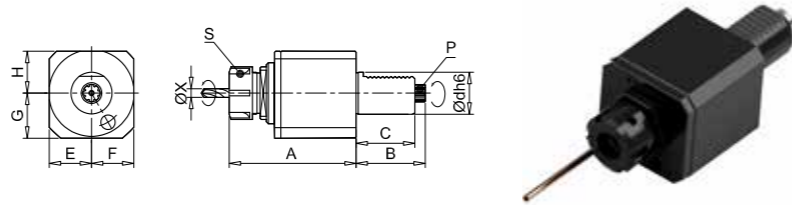

Part Number	Dimensions (mm)									i	Nmax RPM	S	T Nm	P	Price
	Ødh6	A	B	C	E	F	G	H	ØX						
OM33432	30	94	55	45	30	30	30	28	1-13	1:1	6000	ER20	40	B15x12-9b	£450.00
OM33238	30	98.5	55	45	30	30	30	28	1-13	1:1	6000	ER25	40	B15x12-9b	£450.00
OM33433	40	123	63	53	41	41	43	40	1-13	1:1	5000	ER32	70	B17x14-9b	£785.00

VDI ATH Axial Tool Head - Round, External Nut

- DIN 5482
- VDI Driven Tool Holders

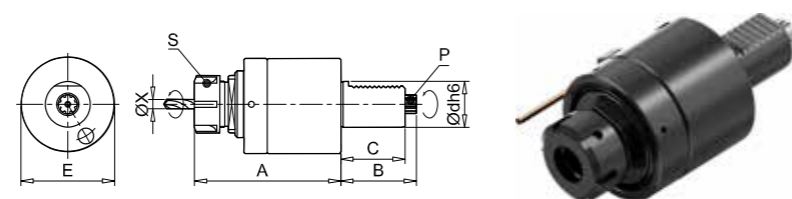

Part Number	Dimensions (mm)					i	Nmax RPM	S	T Nm	P	Price
	Ødh6	A	B	C	ØX						
OM33434	30	98.5	55	45	68	1:1	6000	ER25	40	B15x12-9b	£450.00
OM33435	40	120.5	63	53	83	1:1	5000	ER32	70	B17x14-9b	£785.00

VDI ATH Axial Tool Head - Round, Internal Nut

- DIN 5482
- VDI Driven Tool Holders

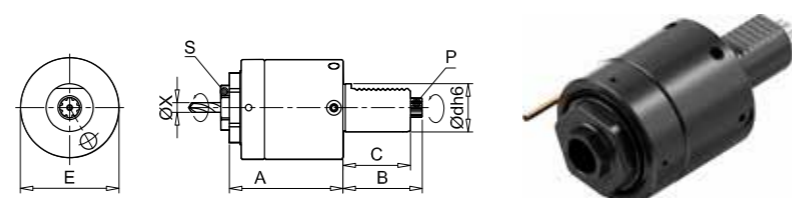

Part Number	Dimensions (mm)					i	Nmax RPM	S	T Nm	P	Price
	Ødh6	A	B	C	ØX						
OM33436	30	80	55	45	1-16	1:1	6000	ER25	40	B15x12-9b	£450.00
OM33437	40	95	63	53	1-20	1:1	5000	ER32	70	B17x14-9b	£785.00

VDI ATH Axial Tool Head - Short

- DIN 5482
- VDI Driven Tool Holders

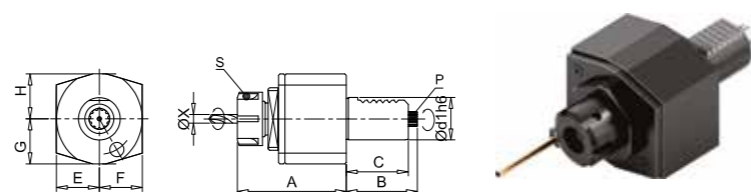

Part Number	Dimensions (mm)									i	Nmax RPM	S	T Nm	P	Price
	Ødh6	A	B	C	E	F	G	H	ØX						
OM33438	30	78	55	45	35	35	33	33	1-13	1:1	4000	ER20	40	B15x12-9b	£795.00
OM33439	40	85	63	53	42.5	42.5	38	38	1-20	1:1	4000	ER32	70	B17x14-9b	£1,065.00

RTH Radial Tool Head

- DIN 5482
- VDI Driven Tool Holders

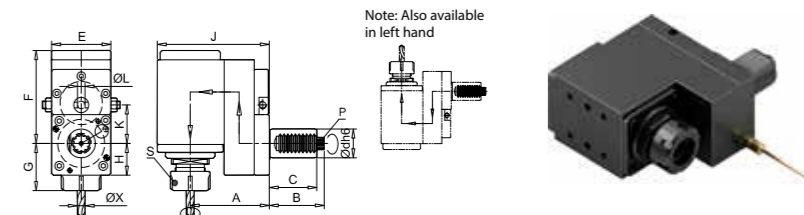

Part Number		Dimensions (mm)											i	Nmax RPM	S	T Nm	P	Price	
R/H	L/H	Ødh6	A	B	C	E	F	G	H	J	K	ØL							ØX
OM33237	OM33479	30	89	55	45	63	96.5	49	33	124	40	8	1-16	1:1	6000	ER25	40	B15x12-9b	£1,150.00
OM33440	OM33480	40	98	63	53	80	108.5	43	43	138	63	10	1-20	1:1	5000	ER32	70	B17x14-9b	£1,295.00

RTH Radial Tool Head - Direct

- DIN 5482
- VDI Driven Tool Holders

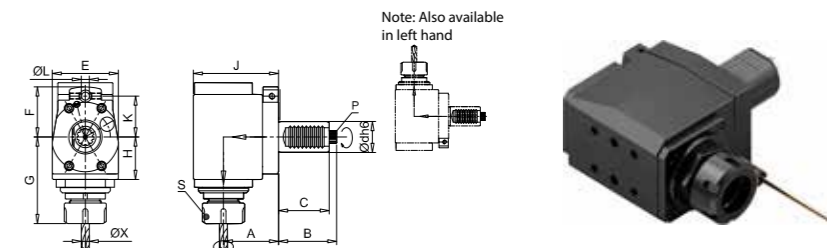

Part Number		Dimensions (mm)											i	Nmax RPM	S	T Nm	P	Price	
R/H	L/H	Ødh6	A	B	C	E	F	G	H	J	K	ØL							ØX
OM33441	OM33481	30	55	55	45	66	53	84.5	41.5	85	40	8	1-16	1:1	6000	ER25	40	B15x12-9b	£1,150.00
OM33442	OM33482	40	64	63	53	76	74	90	43	98	63	10	1-20	1:1	5000	ER32	70	B17x14-9b	£1,295.00

RTH Radial Tool Head - Internal Nut, Through Coolant

- DIN 5482
- VDI Driven Tool Holders

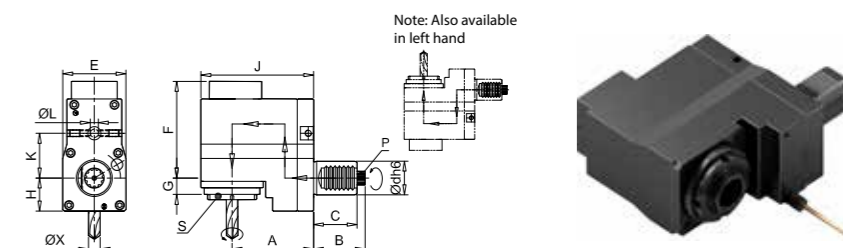

Part Number		Dimensions (mm)											i	Nmax RPM	S	T Nm	P	Price	
R/H	L/H	Ødh6	A	B	C	E	F	G	H	J	K	ØL							ØX
OM33443	OM33483	40	99.5	63	53	77	115.5	33	39.5	137.5	63	10	1-20	1:1	5000	ER32	70	B17x14-9b	£1,500.00

VDI (08869888)

VDI (08869888)

VDI ATH

Axial Tool Head - Square, External Nut

- DIN 5480
- VDI Driven Tool Holders

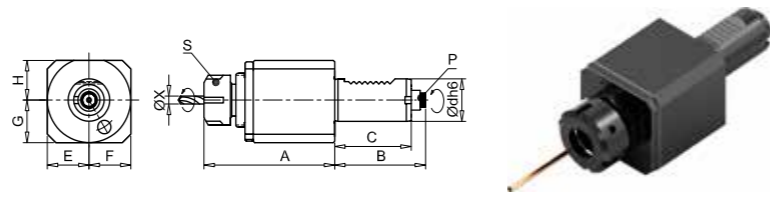

Part Number	Dimensions (mm)									i	Nmax RPM	S	T Nm	P	Price
	Ødh6	A	B	C	E	F	G	H	ØX						
OM33444	16	65	42	32	21	25	21	21	1-7	1:1	6000	ER11	6.3	W8x0.8x30°x18-9b	£420.00
OM33207	20	94	51	40	30	30	27	28	1-13	1:1	6000	ER20	10	W10x0.8x30°x11-9b	£420.00
OM33445	30	94	67	55	30	30	30	28	1-13	1:1	6000	ER20	40	W16x0.8x30°x18-9b	£665.00
OM33297	30	98.5	67	55	30	30	30	28	1-16	1:1	6000	ER25	40	W16x0.8x30°x18-9b	£665.00
OM33236	40	123	75	63	41	41	43	40	1-20	1:1	5000	ER32	70	W20x0.8x30°x24-9b	£930.00

VDI ATH

Axial Tool Head - Round, External Nut

- DIN 5480
- VDI Driven Tool Holders

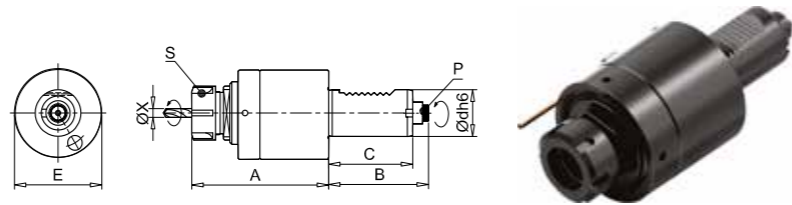

Part Number	Dimensions (mm)						i	Nmax RPM	S	T Nm	P	Price
	Ødh6	A	B	C	E	ØX						
OM33446	30	99.5	67	55	68	1-16	1:1	6000	ER25	40	W16x0.8x30°x18-9b	£665.00
OM33447	40	120.5	75	63	83	1-20	1:1	5000	ER32	70	W20x0.8x30°x24-9b	£930.00

VDI ATH

Axial Tool Head - Round, Internal Nut

- DIN 5480
- VDI Driven Tool Holders

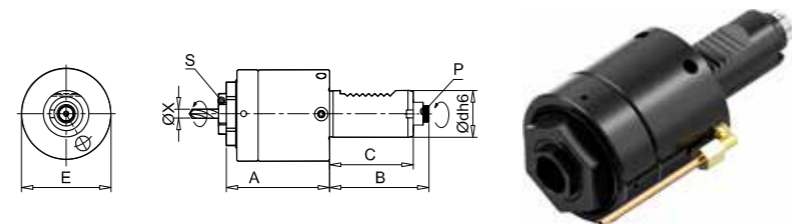

Part Number	Dimensions (mm)						i	Nmax RPM	S	T Nm	P	Price
	Ødh6	A	B	C	E	ØX						
OM33448	30	80	67	55	68	1-16	1:1	6000	ER25	40	W16x0.8x30°x18-9b	£665.00
OM33449	40	95	75	63	83	1-20	1:1	5000	ER32	70	W20x0.8x30°x24-9b	£930.00

VDI ATH

Axial Tool Head - Short

- DIN 5480
- VDI Driven Tool Holders

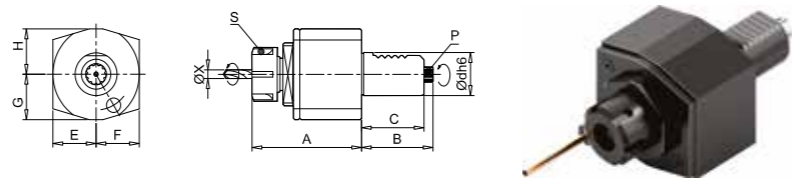

Part Number	Dimensions (mm)									i	Nmax RPM	S	T Nm	P	Price
	Ødh6	A	B	C	E	F	G	H	ØX						
OM33450	20	76	51	40	31	31	35	28	1-10	1:1	4000	ER16	10	W10x0.8x30°x11-9b	£540.00

ATH

Axial Tool Head - Internal Nut, Through Coolant

- DIN 5480
- VDI Driven Tool Holders

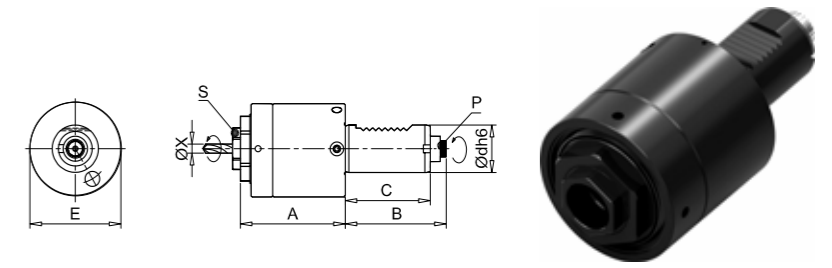

Part Number	Dimensions (mm)						i	Nmax RPM	S	T Nm	P	Price
	Ødh6	A	B	C	E	ØX						
OM33451	30	80	67	55	68	1-16	1:1	6000	ER25	40	W16x0.8x30°x18-9b	£795.00
OM33452	40	95	75	83	83	1-20	1:1	5000	ER32	70	W20x0.8x30°x24-9b	1,120.00

RTH

Radial Tool Head

- DIN 5480
- VDI Driven Tool Holders

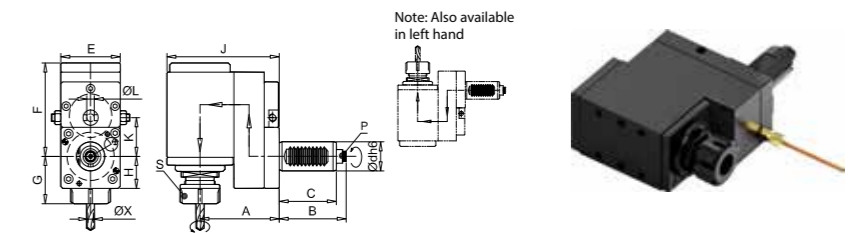

Part Number		Dimensions (mm)											i	Nmax RPM	S	T Nm	P	Price	
R/H	L/H	Ødh6	A	B	C	E	F	G	H	J	K	ØL							ØX
OM33453	OM33484	20	57	51	40	50	70	49	33	119	40	8	1-16	1:1	6000	ER25	10	W10x0.8x30°x11-9b	£860.00
OM33454	OM33485	30	89	67	55	63	96.5	49	33	124	48	8	1-16	1:1	6000	ER25	40	W16x0.8x30°x18-9b	£1,470.00
OM33455	OM33486	40	98	75	63	80	108.5	43	43	138	56	10	1-20	1:1	5000	ER32	70	W20x0.8x30°x24-9b	£1,670.00

RTH

Radial Tool Head - Direct

- DIN 5480
- VDI Driven Tool Holders

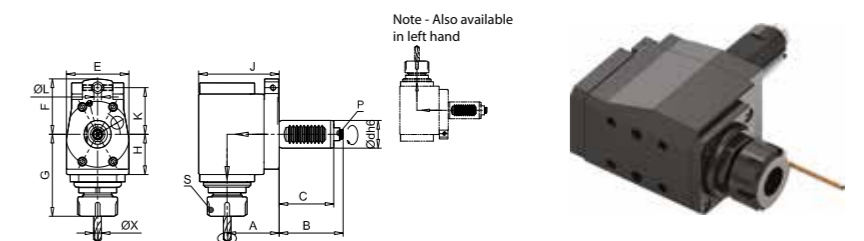

Part Number		Dimensions (mm)											i	Nmax RPM	S	T Nm	P	Price	
R/H	L/H	Ødh6	A	B	C	E	F	G	H	J	K	ØL							ØX
OM33456	OM33487	16	34	42	32	42	61	46	25	50	54	8	1-7	1:1	6000	ER11	6.3	W8x0.8x30°x18-9b	£855.00
OM33457	OM33488	30	55	67	55	66	53	84.5	41.5	85	48	8	1-16	1:1	6000	ER25	40	W16x0.8x30°x18-9b	£1,315.00
OM33458	OM33489	40	64	75	63	76	69	90	43	98	56	10	1-20	1:1	5000	ER32	70	W20x0.8x30°x24-9b	£1,435.00

108699101 ICA

108699101 ICA

VDI ATH

Axial Tool Head, For Radial Disc Single End

- DIN 5480
- VDI Driven Tool Holders

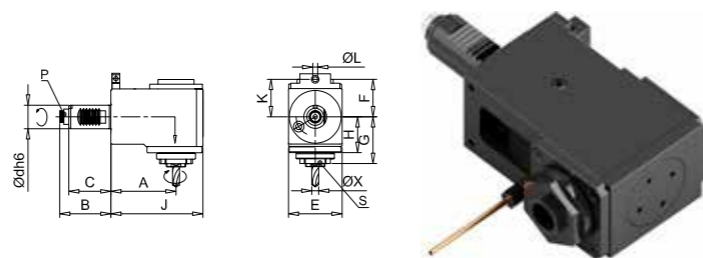

Part Number	Dimensions (mm)											i	Nmax RPM	S	T Nm	P	Price	
	Ødh6	A	B	C	E	F	G	H	J	K	ØL							ØX
OM33459	30	85	67	55	70	49.5	64.5	45.5	120	48	8	1-16	1:1	6000	ER25	40	W16x0.8x30°x18-9b	£1,590.00
OM33460	40	100	75	63	76	54	74.5	53	144	56	10	1-20	1:1	5000	ER32	70	W20x0.8x30°x24-9b	£1,970.00

VDI ATH

Axial Tool Head, For Radial Disc Single End - Through Coolant

- DIN 5480
- VDI Driven Tool Holders

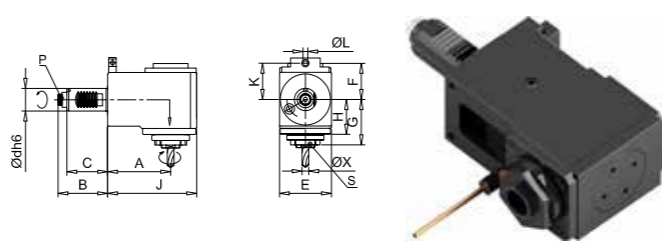

Part Number	Dimensions (mm)											i	Nmax RPM	S	T Nm	P	Price	
	Ødh6	A	B	C	E	F	G	H	J	K	ØL							ØX
OM33461	30	85	67	55	70	58.5	64.5	45.5	120	48	8	1-16	1:1	6000	ER25	40	W16x0.8x30°x18-9b	£1,595.00
OM33462	40	100	75	63	76	64.5	74.5	53	144	56	10	1-20	1:1	5000	ER32	70	W20x0.8x30°x24-9b	£1,970.00

VDI ATH

Axial Tool Head, For Radial Disc Single End - Double Serration

- DIN 5480
- VDI Driven Tool Holders

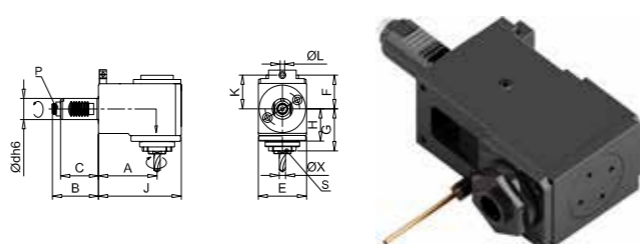

Part Number	Dimensions (mm)											i	Nmax RPM	S	T Nm	P	Price	
	Ødh6	A	B	C	E	F	G	H	J	K	ØL							ØX
OM33463	30	100	67	55	62	49.5	64.5	45.5	132	48	8	1-16	1:1	6000	ER25	40	W16x0.8x30°x18-9b	£1,670.00

VDI ATH

Axial Tool Head, For Radial Disc Double End

- DIN 5480
- VDI Driven Tool Holders

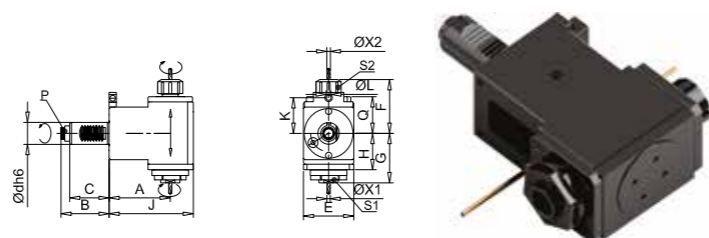

Part Number	Dimensions (mm)											S1	S2	i	Nmax RPM	T Nm	P	Price		
	Ødh6	A	B	C	E	F	G	H	J	K	ØL								ØX1	ØX2
OM33464	30	85	67	55	70	75.5	68.5	49.5	117	48	8	1-16	1-13	ER25	ER20	1:1	6000	40	W16x-0.8x30°x18-9b	£1,700.00
OM33465	30	100	67	55	62	75.5	68.5	49.5	132	48	8	1-16	1-13	ER25	ER20	1:1	6000	40	W16x-0.8x30°x18-9b	£1,810.00
OM33466	40	100	75	63	76	78.5	74.5	53	141	56	10	1-20	1-13	ER32	ER20	1:1	5000	70	W20x-0.8x30°x24-9b	£1,985.00
OM33467	40	120	75	63	76	78.5	74.5	53	161	56	10	1-20	1-13	ER32	ER20	1:1	5000	70	W20x-0.8x30°x24-9b	£2,270.00

ATH

Axial Tool Head

- DIN 1809
- VDI Driven Tool Holders

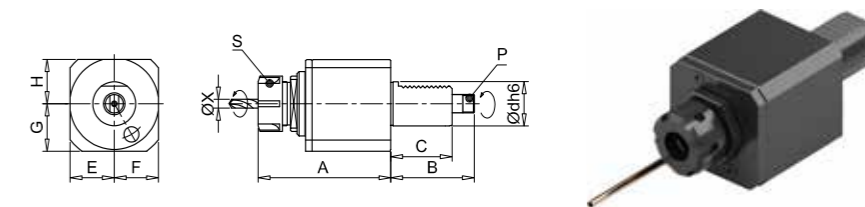

Part Number	Dimensions (mm)										i	Nmax RPM	S	T Nm	P	Turret Type	Price
	Ødh6	A	B	C	E	F	G	H	ØX								
OM33468	30	94	62	50.5	30	30	30	28	1-13	1:1	6000	ER20	40	Ø12x6x7	Duplomatic	£450.00	
OM33469	30	98.5	62	50.5	30	30	30	28	1-16	1:1	6000	ER25	40	Ø12x6x7	Duplomatic	£450.00	
OM33470	30	98.5	66.5	55	30	30	30	28	1-16	1:1	6000	ER25	40	Ø13.5x8x7	EWS	£450.00	
OM33471	40	123	72	56	41	41	43	40	1-20	1:1	5000	ER32	70	Ø14x8x6.5	Duplomatic	£785.00	

RTH

Radial Tool Head

- DIN 1809
- VDI Driven Tool Holders

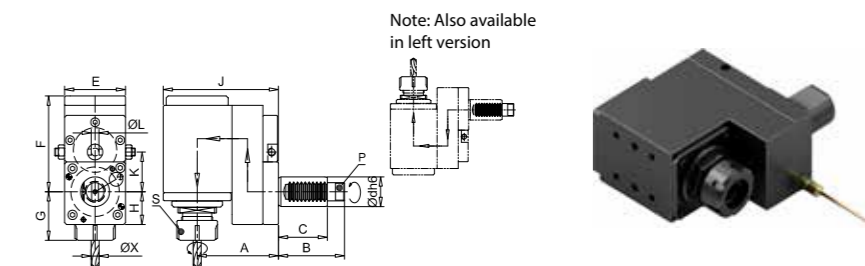

Part Number	R/H	L/H	Dimensions (mm)										i	Nmax RPM	S	T Nm	P	Turret Type	Price	
			Ødh6	A	B	C	E	F	G	H	J	K								ØL
OM33472	OM33490	30	84	62	50.5	63	96.5	49	33	119	40	8	1-16	1:1	6000	ER25	40	Ø12x6x7	Duplomatic	£1,150.00
OM33473	OM33491	30	84	66.5	55	63	96.5	49	33	119	40	8	1-16	1:1	6000	ER25	40	Ø13.5x8x7	EWS	£1,150.00
OM33474	OM33492	40	91	72	56	80	106.5	43	43	131	63	10	1-20	1:1	5000	ER32	70	Ø14x8x6.5	Duplomatic	£1,295.00

RTH

Radial Tool Head - Direct

- DIN 1809
- VDI Driven Tool Holders

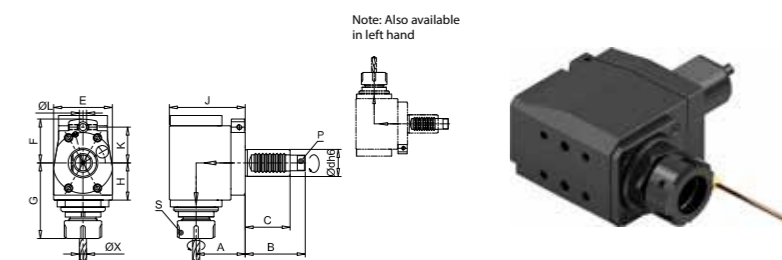

Part Number	R/H	L/H	Dimensions (mm)										i	Nmax RPM	S	T Nm	P	Turret Type	Price	
			Ødh6	A	B	C	E	F	G	H	J	K								ØL
OM33475	OM33493	30	55	62	50.5	66	53	84.5	41.5	85	40	8	1-16	1:1	6000	ER25	40	Ø12x6x7	Duplomatic	£1,150.00

ATH TOEM Axial Tool Head

- TOEM Coupling For Baruffaldi Turret
- VDI Driven Tool Holders

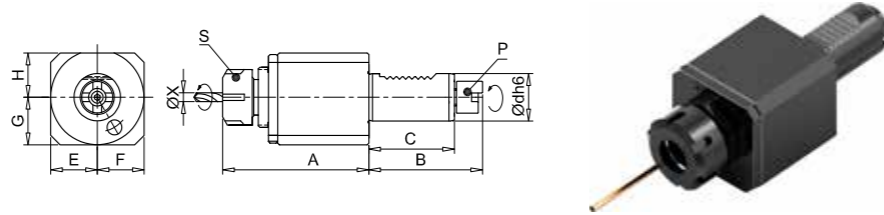

Part Number	Dimensions (mm)									i	Nmax RPM	S	T Nm	P	Turret Type	Price
	Ødh6	A	B	C	E	F	G	H	ØX							
OM33476	16	65	48	35	21	25	21	21	1-7	1:1	6000	ER11	6.3	Ø14.5x4x4	Baruffaldi	£470.00
OM33477	30	98.5	59	45	30	30	30	28	1-16	01:01	6000	ER25	40	Ø24x6x3.2	Baruffaldi	£470.00

RTH DIRECT TOEM Radial Tool Head

- TOEM Coupling For Baruffaldi Turret
- VDI Driven Tool Holders

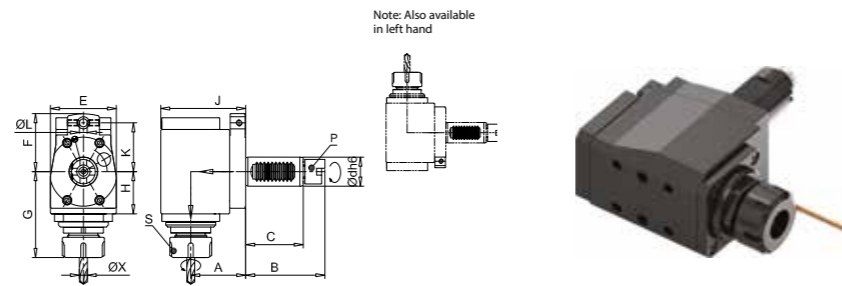

Part Number		Dimensions (mm)												i	Nmax RPM	S	T Nm	P	Turret Type	Price
R/H	L/H	Ødh6	A	B	C	E	F	G	H	J	K	ØL	ØX							
OM33478	OM33494	16	34	48	35	42	61	46	25	50	54	8	1-7	1:1	6000	ER11	6.3	Ø14.5x4x4	Baruffaldi	£1,230.00

VDI COUPLING TYPES

- Listed below are the four most common coupling types
- Any coupling can be manufactured as a special, to any customer specific requirement

DIN 5480



DIN 5482



BARUFFALDI



DIN 1809



STRAIGHT SHANK COLLET CHUCKS ER COLLET EXTENSIONS

- Standard = Castle Nut
- A = Hexagon Nut
- ER Collets – Pg. 154
- Spares – Pg. 214

Part Number	Description	Shank Diameter (mm)	Collet Type	Shank Length (mm)	Price
OM30010	C16 ER11A x 150	16	ER11	150	£25.00
OM30014	C16 ER16A x 50		ER16	50	£25.00
OM30012	C16 ER16A x 100		ER16	100	£25.00
OM30013	C16 ER16A x 150		ER16	150	£25.00
OM30020	C20 ER16A x 50	20	ER16	50	£25.00
OM30018	C20 ER16A x 100		ER16	100	£25.00
OM30019	C20 ER16A x 150		ER16	150	£25.00
OM30027	C20 ER20 x 50		ER20	50	£25.00
OM30025	C20 ER20 x 100		ER20	100	£25.00
OM30026	C20 ER20 x 150		ER20	150	£25.00
OM30030	C20 ER25 x 50		ER25	50	£25.00
OM30029	C20 ER25 x 100		ER25	100	£25.00
OM30032	C20 ER32 x 50		ER32	50	£25.00
OM30031	C20 ER32 x 100		ER32	100	£25.00
OM30033	C25 ER16 x 150	25	ER16	150	£25.00
OM30037	C25 ER20 x 150		ER20	150	£25.00
OM30039	C25 ER25 x 50		ER25	50	£25.00
OM30038	C25 ER25 x 100		ER25	100	£25.00
OM30265	C25 ER25 X 150		ER25	150	£25.00
OM30137	C25 ER25 x 200		ER25	200	£34.00
OM30041	C25 ER32 x 50		ER32	50	£25.00
OM30040	C25 ER32 x 100		ER32	100	£25.00
OM30497	C25 ER32 x 200		ER32	200	£34.00
OM30042	C25 ER40 x 50		ER40	50	£30.00
OM30171	C32 ER25 x 100	32	ER25	100	£25.00
OM30044	C32 ER32 x 50		ER32	50	£25.00
OM30045	C32 ER32 x 60		ER32	60	£25.00
OM30043	C32 ER32 x 100		ER32	100	£25.00
OM30046	C32 ER40 x 50		ER40	50	£30.00
OM30369	C40 ER25 x 100	40	ER25	100	£34.00
OM30048	C40 ER32 x 85		ER32	85	£34.00
OM30047	C40 ER32 x 100		ER32	100	£34.00



MINI STRAIGHT SHANK COLLET CHUCKS ER COLLET EXTENSIONS

- Mini Nut
- ER Collets – Pg. 154
- Spares – Pg. 214

Part Number	Description	Shank Diameter (mm)	Collet Type	Shank Length (mm)	Price	
OM30001	C08 ER8M x 55	8	ER8	55	£25.00	
OM30494	C08 ER8M x 100		ER8	100	£25.00	
OM30002	C10 ER8M x 100	10	ER8	100	£25.00	
OM30003	C10 ER8M x 150		ER8	150	£25.00	
OM30495	C10 ER11M X 100	12	ER11	100	£25.00	
OM30006	C12 ER8M x 55		ER8	55	£25.00	
OM30005	C12 ER8M x 120		ER8	120	£25.00	
OM30175	C12 ER8M x 150		ER8	150	£25.00	
OM30176	C12 ER8M x 200		ER8	200	£34.00	
OM30004	C12 ER11M x 80		ER11	80	£25.00	
OM30136	C12 ER11M x 150		ER11	150	£25.00	
OM30147	C12 ER11M x 200		ER11	200	£34.00	
OM30009	C16 ER11M x 50		16	ER11	50	£25.00
OM30007	C16 ER11M x 100			ER11	100	£25.00
OM30008	C16 ER11M x 150	ER11		150	£25.00	
OM30011	C16 ER16M x 50	ER16		50	£25.00	
OM30496	C16 ER16M x 100	ER16		100	£25.00	
OM30017	C20 ER16M x 60	20	ER16	60	£25.00	
OM30015	C20 ER16M x 100		ER16	100	£25.00	
OM30016	C20 ER16M x 150		ER16	150	£25.00	
OM30096	C20 ER16M x 200		ER16	200	£34.00	
OM30099	C20 ER16M x 300		ER16	300	£48.00	
OM30024	C20 ER20M x 50		ER20	50	£25.00	
OM30021	C20 ER20M x 100		ER20	100	£25.00	
OM30022	C20 ER20M x 150		ER20	150	£25.00	
OM30023	C20 ER20M x 200		ER20	200	£34.00	
OM30028	C20 ER25M x 100		ER25	100	£25.00	
OM30139	C22 ER16M x 70	22	ER16	70	£34.00	
OM30000	C22 ER20M x 100		ER20	100	£34.00	
OM30036	C25 ER20M x 60	25	ER20	60	£25.00	
OM30034	C25 ER20M x 100		ER20	100	£25.00	
OM30035	C25 ER20M x 150		ER20	150	£25.00	
OM30140	C32 ER20M x 100	32	ER20	100	£42.00	



STRAIGHT SHANK

STRAIGHT SHANK

STRAIGHT SHANK COLLET CHUCKS DMC COLLET EXTENSIONS

- For Ultra Precision DMC Style Collets
- DMC Collets – Pg. 184
- Hex Keys – Pg. 217

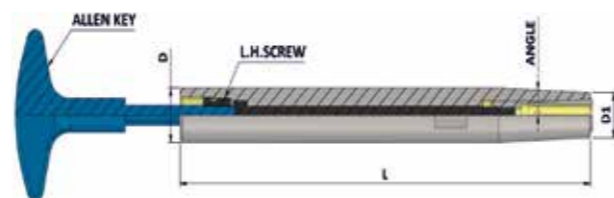

Part Number	Description	Clamping Range	Dimensions (mm)			Angle	Collet	Screw	Allen Key	Price
			D	D1	L					
OM32374	D16 DMC 06 L 150	3-6	16	13	150	3°	DMC-06	M5	4X200	£72.00
OM32375	D20 DMC 06 L 200	3-6	20	13	200	3°	DMC-06	M5	4X200	£79.00
OM32376	D25 DMC 06 L 250	3-6	25	13	250	3°	DMC-06	M5	4X200	£119.00
OM32377	D20 DMC 08 L 150	3-8	20	19	150	3°	DMC-08	M6	5X200	£79.00
OM32378	D20 DMC 08 L 200	3-8	20	19	200	3°	DMC-08	M6	5X200	£119.00
OM32379	D25 DMC 10 L 150	3-10	25	24	150	3°	DMC-10	M8	6X200	£98.00
OM32380	D25 DMC 10 L 200	3-10	25	24	200	3°	DMC-10	M8	6X200	£119.00
OM32381	D25 DMC 10 L 250	3-10	25	24	250	3°	DMC-10	M8	6X200	£139.00



EXTENSION CHUCKS SHRINK FIT

- Cylindrical Shank
- Superior Clamping Strength & Rigidity
- 4.5 Degree

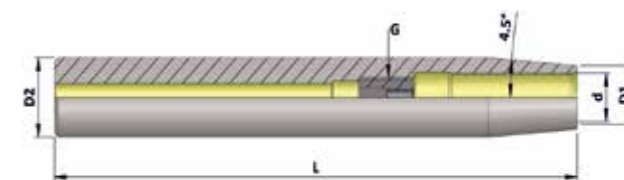

12mm Cylindrical Shank

Part Number	Description	Dimensions (mm)					Price
		D	D1	D2	G	L	
OM33628	D12 SF03 150	3	8	12	-	150	£69.00
OM33629	D12 SF04 150	4	8	12	-	150	£69.00

16mm Cylindrical Shank

Part Number	Description	Dimensions (mm)					Price
		D	D1	D2	G	L	
OM33630	D16 SF03 150	3	10	16	-	150	£69.00
OM33631	D16 SF04 150	4	10	16	-	150	£69.00
OM33632	D16 SF05 150	5	10	16	-	150	£69.00
OM33633	D16 SF06 150	6	10	16	M5	150	£61.00

20mm Cylindrical Shank

Part Number	Description	Dimensions (mm)					Price
		D	D1	D2	G	L	
OM33634	D20 SF03 150	3	10	20	-	150	£69.00
OM33635	D20 SF04 150	4	10	20	-	150	£69.00
OM33636	D20 SF05 150	5	10	20	-	150	£69.00
OM33637	D20 SF06 150	6	10	20	M5	150	£61.00
OM33638	D20 SF08 150	8	12	20	M6	150	£61.00
OM33639	D20 SF10 150	10	14	20	M8	150	£61.00
OM33640	D20 SF12 150	12	16	20	M10	150	£61.00

25mm Cylindrical Shank

Part Number	Description	Dimensions (mm)					Price
		D	D1	D2	G	L	
OM33641	D25 SF08 150	8	20	25	M6	150	£61.00
OM33642	D25 SF10 150	10	20	25	M8	150	£61.00
OM33643	D25 SF12 150	12	20	25	M10	150	£61.00
OM33644	D25 SF14 150	14	20	25	M10	150	£61.00
OM33645	D25 SF16 150	16	22	25	M12	150	£61.00

32mm Cylindrical Shank

Part Number	Description	Dimensions (mm)					Price
		D	D1	D2	G	L	
OM33646	D32 SF10 150	10	24	32	M8	150	£61.00
OM33647	D32 SF12 150	12	24	32	M10	150	£61.00
OM33648	D32 SF14 150	14	27	32	M10	150	£61.00
OM33649	D32 SF16 150	16	27	32	M12	150	£61.00
OM33650	D32 SF18 150	18	27	32	M12	150	£61.00
OM33651	D32 SF20 150	20	27	32	M16	150	£61.00



MLC SYNCHRO TAPPING CHUCKS STRAIGHT SHANK

- Minimum Length Compensation Tapping Chucks
- +/-0.5mm Compression & Expansion
- High Concentricity Enables High Speed Tapping
- Recommended for use with QCTC Type Collets
- QCTC Collets – Pg. 186
- Spares – Pg. 214

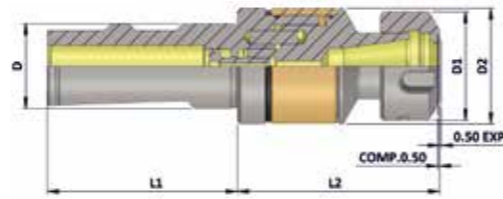

Part Number	Description	Capacity	Clamping Range	Nut Size	Dimensions (mm)							Price
					D	D1	D2	L1	L2	Comp.	Exp.	
OM32477	D20 ER16 Mini	M3-M12	1-10	ER16M	20	22	34	51	58	0.5	0.5	£100.00
OM32487	D20 ER16	M3-M12	1-10	ER16	20	32	34	51	58	0.5	0.5	£100.00
OM32500	D25 ER16 Mini	M3-M12	1-10	ER16M	25	22	34	56	60	0.5	0.5	£100.00
OM32501	D25 ER16	M3-M12	1-10	ER16	25	32	34	56	60	0.5	0.5	£100.00
OM32502	D25 ER20	M3-M16	3.5-10	ER20	25	35	34	56	61	0.5	0.5	£100.00
OM32503	D25 ER25	M3-M20	3.5-16	ER25	25	42	34	56	65	0.5	0.5	£100.00
OM32504	D25 ER32	M4-M27	3.5-20	ER32	25	50	45	56	87	0.5	0.5	£100.00
OM32505	D32 ER40	M6-M33	6-26	ER40	32	63	62	61	108.5	0.5	0.5	£115.00

FLOATING REAMER HOLDER STRAIGHT SHANK

- Short Length Floating Reamer Holder with radial parallel float of 1.0mm
- Integral weight balancing mechanism
- Excellent problem solver for poor surface finish & over size cutting
- Spares – Pg. 215, 217

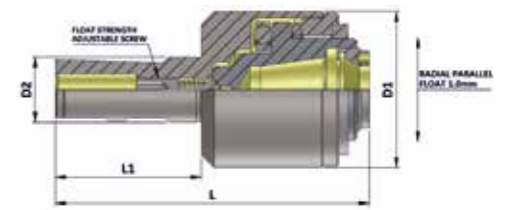

Part Number	Description	Dimensions (mm)				Collet Capacity	Spanner	Radial Parallel Float	Price
		D1	D2	L	L1				
OM32506	FRH 20mm ER25A	60	20	116	51	1-16	E25A	1.0 mm	£125.00
OM32507	FRH 25mm ER25A	60	25	121	56	1-16	E25A	1.0 mm	£125.00
OM32508	FRH 32mm ER25A	60	32	126	61	1-16	E25A	1.0 mm	£125.00

QUICK CHANGE TAPPING CHUCKS STRAIGHT SHANK

- Axial Length Compensation
- With Tension & Compression
- Quick change tap adaptors available in 3 sizes
- QC Tap Adaptors – Pg. 192



Part Number	Description	Shank Dia (mm)	Gauge Length (mm)	Tapping Range	Price
OM31367	C20 Size 1 (TC312-41)	20	41	M3 - M12	£96.00
OM31368	C25 Size 1 (TC312-41)	25	41	M3 - M12	£96.00
OM31369	C32 Size 1 (TC312-41)	32	41	M3 - M12	£96.00
OM31370	C25 Size 2 (TC820-63)	25	63	M6 - M20	£98.00
OM31371	C32 Size 2 (TC820-63)	32	63	M6 - M20	£98.00
OM31372	C32 Size 3 (TC1433-97)	32	97	M14 - M36	£239.00

PRECISION DRILL CHUCK STRAIGHT SHANK

- Hexagonal Key Drill Chuck
- High Accuracy Drill Chuck
- Increased wear-resistance with Titanium Jaws
- Spare Hex Key – Pg. 217

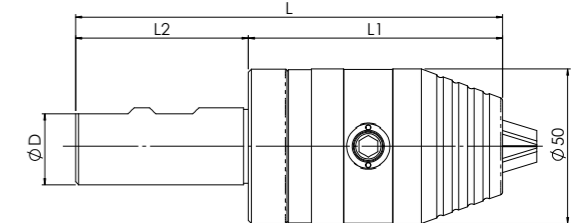

Part Number	Description	Dimensions (mm)					Price
		Capacity	L	L1	L2	D	
OM33674	D20 GHK13 83	0.3-13	133	50	83	20	£124.00
OM33675	D25 GHK13 83	0.3-13	139	56	83	25	£124.00

ER COLLET CHUCKS R8 (BRIDGEPORT)

- 7/16 UNF Drawbar Thread

Part Number	Description	Price
OM31314	R8 ER16	£39.00
OM31449	R8 ER25	£39.00
OM31315	R8 ER32	£39.00
OM31316	R8 ER40	£52.00



END MILL HOLDERS R8 (BRIDGEPORT)

- 7/16 UNF Drawbar Thread

Part Number	Description	Bore Size	Price
OM31327	R8 S/L 10	10mm	£29.00
OM31328	R8 S/L 12	12mm	£29.00
OM31329	R8 S/L 16	16mm	£29.00
OM31330	R8 S/L 20	20mm	£29.00
OM31331	R8 S/L 25	25mm	£35.00
OM31332	R8 S/L 32	32mm	£35.00



FACE MILL ARBORS R8 (BRIDGEPORT)

- 7/16 UNF Drawbar Thread

Part Number	Description	Spigot Size	Price
OM31318	R8 FMB 16	16mm	£29.00
OM31319	R8 FMB 22	22mm	£29.00
OM31320	R8 FMB 27	27mm	£29.00
OM31321	R8 FMB 32	32mm	£29.00



MORSE TAPER ADAPTORS R8 (BRIDGEPORT)

- 7/16 UNF Drawbar Thread

Part Number	Description	Price
OM31323	R8 MTA 1	£23.00
OM31324	R8 MTA 2	£23.00
OM31325	R8 MTA 3	£23.00
OM31326	R8 MTA 4	£23.00



DRILL CHUCK ARBORS R8 (BRIDGEPORT)

- 7/16 UNF Drawbar Thread

Part Number	Description	Price
OM31322	R8 JT6	£12.00
OM31363	R8 B16	£16.00



R8 COLLETS R8 (BRIDGEPORT)

- 7/16 UNF Drawbar Thread

Part Number	Description	Clamping Size (mm)	Price
OM31295	R8 2mm	2	£11.00
OM31296	R8 3mm	3	£11.00
OM31297	R8 4mm	4	£11.00
OM31298	R8 5mm	5	£11.00
OM31299	R8 6mm	6	£11.00
OM31300	R8 7mm	7	£11.00
OM31301	R8 8mm	8	£11.00
OM31302	R8 9mm	9	£11.00
OM31303	R8 10mm	10	£11.00
OM31304	R8 11mm	11	£11.00
OM31305	R8 12mm	12	£11.00
OM31306	R8 13mm	13	£11.00
OM31307	R8 14mm	14	£11.00
OM31308	R8 15mm	15	£11.00
OM31309	R8 16mm	16	£11.00
OM31310	R8 17mm	17	£11.00
OM31311	R8 18mm	18	£11.00
OM31312	R8 19mm	19	£11.00
OM31313	R8 20mm	20	£11.00



R8
(BRIDGEPORT)

R8
(BRIDGEPORT)

ER8 COLLETS STANDARD



- Standard ER Collets
- (<10µ accuracy)
- Clamping Range 1.0 - 5.0mm

Part Number	Description	Clamping Size (mm)	Price
OM32000	ER8 Standard Collet (10 micron accuracy)	1.0-0.5	£9.60
OM32001		1.5-1.0	£9.60
OM32002		2.0-1.5	£8.30
OM32003		2.5-2.0	£8.30
OM32004		3.0-2.5	£8.30
OM32005		3.5-3.0	£8.30
OM32006		4.0-3.5	£8.30
OM32007		4.5-4.0	£8.30
OM32008		5.0-4.5	£8.30

ER8 COLLETS ULTRA PRECISION



- Ultra Precision ER Collets
- (<5µ accuracy)
- Clamping Range 1.0 - 5.0mm

Part Number	Description	Clamping Size (mm)	Price
OM32018	ER8 Ultra Precision Collet (5 micron accuracy)	1.0-0.5	£17.75
OM32019		1.5-1.0	£17.75
OM32020		2.0-1.5	£15.60
OM32021		2.5-2.0	£15.60
OM32022		3.0-2.5	£15.60
OM32023		3.5-3.0	£15.60
OM32024		4.0-3.5	£15.60
OM32025		4.5-4.0	£15.60
OM32026		5.0-4.5	£15.60

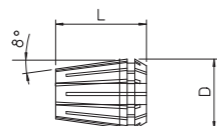

D	8.5mm
L	13mm
Clamping Range	1.0 - 5.0mm

ER16 COLLETS STANDARD



- Standard ER Collets
- (<10µ accuracy)
- Clamping Range 1.0 - 12.0mm

Part Number	Description	Clamping Size (mm)	Price
OM32072	ER16 Standard Collet (10 micron accuracy)	1.0-0.5	£5.20
OM32082		1.5-1.0	£7.80
OM32073		2.0-1.0	£5.20
OM32083		2.5-2.0	£6.80
OM32074		3.0-2.0	£5.20
OM32084		3.5-2.5	£6.80
OM32075		4.0-3.0	£5.20
OM32085		4.5-3.5	£6.80
OM32076		5.0-4.0	£5.20
OM32086		5.5-4.5	£6.80
OM32077		6.0-5.0	£5.20
OM32087		6.5-5.5	£6.80
OM32078		7.0-6.0	£5.20
OM32088		7.5-6.5	£6.80
OM32079		8.0-7.0	£5.20
OM32089		8.5-7.5	£6.80
OM32080		9.0-8.0	£5.20
OM32090		9.5-8.5	£6.80
OM32081		10.0-9.0	£5.20
OM33034*		10.5-10.3	£16.00
OM33035*		11.0-10.8	£16.00
OM33036*		11.5-11.3	£16.00
OM33037*		12.0-11.8	£16.00

ER16 COLLETS ULTRA PRECISION



- Ultra Precision ER Collets
- (<5µ accuracy)
- Clamping Range 1.0 - 10.0mm

Part Number	Description	Clamping Size (mm)	Price
OM32110	ER16 Ultra Precision Collet (5 micron accuracy)	1.0-0.5	£16.00
OM32111		1.5-1.0	£16.00
OM32112		2.0-1.0	£12.60
OM32113		2.5-2.0	£12.60
OM32114		3.0-2.0	£11.00
OM32115		3.5-2.5	£11.00
OM32116		4.0-3.0	£11.00
OM32117		4.5-3.5	£11.00
OM32118		5.0-4.0	£11.00
OM32119		5.5-4.5	£11.00
OM32120		6.0-5.0	£11.00
OM32121		6.5-5.5	£11.00
OM32122		7.0-6.0	£11.00
OM32123		7.5-6.5	£11.00
OM32124		8.0-7.0	£11.00
OM32125		8.5-7.5	£11.00
OM32126		9.0-8.0	£11.00
OM32127		9.5-8.5	£11.00
OM32128	10.0-9.0	£11.00	

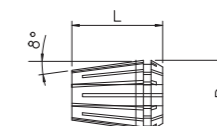

D	17mm
L	27.5mm
Clamping Range	1.0 - 10.0mm

* Collets over 10mm diameter have shorter L dimension

ER11 COLLETS STANDARD



- Standard ER Collets
- (<10µ accuracy)
- Clamping Range 1.0 - 8.0mm

Part Number	Description	Clamping Size (mm)	Price
OM32030	ER11 Standard Collet (10 micron accuracy)	1.0-0.5	£8.20
OM32031		1.5-1.0	£8.20
OM32032		2.0-1.5	£6.80
OM32033		2.5-2.0	£6.80
OM32034		3.0-2.5	£6.80
OM32035		3.5-3.0	£6.80
OM32036		4.0-3.5	£6.80
OM32037		4.5-4.0	£6.80
OM32038		5.0-4.5	£6.80
OM32039		5.5-5.0	£6.80
OM32040		6.0-5.5	£6.80
OM32041		6.5-6.0	£6.80
OM32042		7.0-6.5	£6.80
OM33032*		7.5-7.3	£16.00
OM33033*	8.0-7.8	£16.00	

ER11 COLLETS ULTRA PRECISION



- Ultra Precision ER Collets
- (<5µ accuracy)
- Clamping Range 1.0 - 7.0mm

Part Number	Description	Clamping Size (mm)	Price
OM32056	ER11 Ultra Precision Collet (5 micron accuracy)	1.0-0.5	£17.00
OM32057		1.5-1.0	£17.00
OM32058		2.0-1.5	£14.00
OM32059		2.5-2.0	£14.00
OM32060		3.0-2.5	£11.00
OM32061		3.5-3.0	£11.00
OM32062		4.0-3.5	£11.00
OM32063		4.5-4.0	£11.00
OM32064		5.0-4.5	£11.00
OM32065		5.5-5.0	£11.00
OM32066		6.0-5.5	£11.00
OM32067		6.5-6.0	£11.00
OM32068		7.0-6.5	£11.00

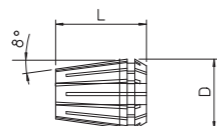

D	11.5mm
L	18mm
Clamping Range	1.0 - 7.0mm

* Collets over 7mm diameter have shorter L dimension

ER20 COLLETS STANDARD



- Standard ER Collets
- (<10µ accuracy)
- Clamping Range 1.0 - 16.0mm

Part Number	Description	Clamping Size (mm)	Price
OM32144	ER20 Standard Collet (10 micron accuracy)	1.0-0.5	£7.80
OM32145		1.5-1.0	£7.80
OM32132		2.0-1.5	£5.70
OM32146		2.5-2.0	£7.20
OM32133		3.0-2.5	£5.70
OM32147		3.5-2.5	£7.20
OM32134		4.0-3.0	£5.70
OM32148		4.5-3.5	£7.20
OM32135		5.0-4.0	£5.70
OM32136		6.0-5.0	£5.70
OM32137		7.0-6.0	£5.70
OM32138		8.0-7.0	£5.70
OM32139		9.0-8.0	£5.70
OM32140		10.0-9.0	£5.70
OM32141		11.0-10.0	£5.70
OM32142		12.0-11.0	£5.70
OM32143		13.0-12.0	£5.70
OM33038*		13.5-13.3	£16.00
OM33039*		14.0-13.8	£16.00
OM33040*		14.5-14.3	£16.00
OM33041*	15.0-14.8	£16.00	
OM33042*	15.5-15.3	£16.00	
OM33043*	16.0-15.8	£16.00	

* Collets over 13mm diameter have shorter L dimension

ER20 COLLETS ULTRA PRECISION



- Ultra Precision ER Collets
- (<5µ accuracy)
- Clamping Range 1.0 - 13.0mm

Part Number	Description	Clamping Size (mm)	Price
OM32166	ER20 Ultra Precision Collet (5 micron accuracy)	1.0-0.5	£15.80
OM32167		1.5-1.0	£15.80
OM32168		2.0-1.0	£13.60
OM32169		2.5-2.0	£13.60
OM32170		3.0-2.5	£11.40
OM32171		3.5-2.5	£11.40
OM32172		4.0-3.0	£11.40
OM32173		4.5-3.5	£11.40
OM32174		5.0-4.0	£11.40
OM32175		6.0-5.0	£11.40
OM32176		7.0-6.0	£11.40
OM32177		8.0-7.0	£11.40
OM32178		9.0-8.0	£11.40
OM32179		10.0-9.0	£11.40
OM32180		11.0-10.0	£11.40
OM32181		12.0-11.0	£11.40
OM32182		13.0-12.0	£11.40

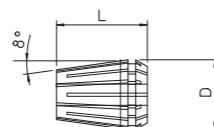

D	21mm
L	31.5mm
Clamping Range	1.0 - 13.0mm

ER25 COLLETS STANDARD



- Standard ER Collets
- (<10µ accuracy)
- Clamping Range 1.0 - 20.0mm

Part Number	Description	Clamping Size (mm)	Price
OM32186	ER25 Standard Collet (10 micron accuracy)	1.0-0.5	£8.40
OM32202		1.5-1.0	£10.40
OM32187		2.0-1.0	£5.30
OM32203		2.5-2.0	£8.40
OM32188		3.0-2.5	£5.30
OM32204		3.5-2.5	£8.40
OM32189		4.0-3.0	£5.30
OM32205		4.5-3.5	£8.40
OM32190		5.0-4.0	£5.30
OM32191		6.0-5.0	£5.30
OM32192		7.0-6.0	£5.30
OM32193		8.0-7.0	£5.30
OM32194		9.0-8.0	£5.30
OM32195		10.0-9.0	£5.30
OM32196		11.0-10.0	£5.30
OM32197		12.0-11.0	£5.30
OM32198		13.0-12.0	£5.30
OM32199		14.0-13.0	£5.30
OM32200		15.0-14.0	£5.30
OM32201		16.0-15.0	£5.30
OM33044*	16.5-16.3	£16.00	
OM33045*	17.0-16.8	£16.00	
OM33046*	17.5-17.3	£16.00	
OM33047*	18.0-17.8	£16.00	
OM33048*	18.5-18.3	£16.00	
OM33049*	19.0-18.8	£16.00	
OM33050*	19.5-19.3	£16.00	
OM33051*	20.0-19.8	£16.00	

* Collets over 16mm diameter have shorter L dimension

ER25 COLLETS ULTRA PRECISION



- Ultra Precision ER Collets
- (<5µ accuracy)
- Clamping Range 1.0 - 16.0mm

Part Number	Description	Clamping Size (mm)	Price
OM32226	ER25 Ultra Precision Collet (5 micron accuracy)	1.0-0.5	£16.50
OM32227		1.5-1.0	£16.50
OM32228		2.0-1.0	£13.50
OM32229		2.5-2.0	£13.50
OM32230		3.0-2.5	£11.00
OM32231		3.5-2.5	£11.50
OM32232		4.0-3.0	£11.00
OM32233		4.5-3.5	£11.50
OM32234		5.0-4.0	£11.00
OM32235		6.0-5.0	£11.00
OM32236		7.0-6.0	£11.00
OM32237		8.0-7.0	£11.00
OM32238		9.0-8.0	£11.00
OM32239		10.0-9.0	£11.00
OM32240		11.0-10.0	£11.00
OM32241		12.0-11.0	£11.00
OM32242		13.0-12.0	£11.00
OM32243		14.0-13.0	£11.00
OM32244	15.0-14.0	£11.00	
OM32245	16.0-15.0	£11.00	

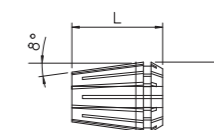

D	26mm
L	34mm
Clamping Range	1.0 - 16.0mm

ER COLLETS

ER COLLETS

ER32 COLLETS STANDARD



- Standard ER Collets
- (<10µ accuracy)
- Clamping Range 1.0 - 25.0mm

Part Number	Description	Clamping Size (mm)	Price
OM32268	ER32 Standard Collet (10 micron accuracy)	1.0-0.5	£12.50
OM32269		1.5-1.0	£12.50
OM32249		2.0-1.5	£10.50
OM32270		2.5-2.0	£10.50
OM32250		3.0-2.0	£5.30
OM32271		3.5-2.5	£9.50
OM32251		4.0-3.0	£5.30
OM32272		4.5-3.5	£9.50
OM32252		5.0-4.0	£5.30
OM32253		6.0-5.0	£5.30
OM32254		7.0-6.0	£5.30
OM32255		8.0-7.0	£5.30
OM32256		9.0-8.0	£5.30
OM32257		10.0-9.0	£5.30
OM32258		11.0-10.0	£5.30
OM32259		12.0-11.0	£5.30
OM32260		13.0-12.0	£5.30
OM32261		14.0-13.0	£5.30
OM32262		15.0-14.0	£5.30
OM32263		16.0-15.0	£5.30
OM32264		17.0-16.0	£5.30
OM32265		18.0-17.0	£5.30
OM32266		19.0-18.0	£5.30
OM32267		20.0-19.0	£5.30
OM33052*		21.0-20.8	£16.00
OM33053*		22.0-21.8	£16.00
OM33054*		23.0-22.8	£16.00
OM33055*		24.0-23.8	£16.00
OM32273*	25.0-24.0	£16.00	

* Collets over 20mm diameter have shorter L dimension

ER32 COLLETS ULTRA PRECISION



- Ultra Precision ER Collets
- (<5µ accuracy)
- Clamping Range 1.0 - 20.0mm

Part Number	Description	Clamping Size (mm)	Price
OM32299	ER32 Ultra Precision Collet (5 micron accuracy)	1.0-0.5	£19.00
OM32300		1.5-1.0	£19.00
OM32301		2.0-1.5	£16.50
OM32302		2.5-2.0	£16.50
OM32303		3.0-2.5	£10.50
OM32304		3.5-2.5	£13.50
OM32305		4.0-3.0	£10.50
OM32306		4.5-3.5	£13.50
OM32307		5.0-4.0	£10.50
OM32308		6.0-5.0	£10.50
OM32309		7.0-6.0	£10.50
OM32310		8.0-7.0	£10.50
OM32311		9.0-8.0	£10.50
OM32312		10.0-9.0	£10.50
OM32313		11.0-10.0	£10.50
OM32314		12.0-11.0	£10.50
OM32315		13.0-12.0	£10.50
OM32316		14.0-13.0	£10.50
OM32317		15.0-14.0	£10.50
OM32318		16.0-15.0	£10.50
OM32319		17.0-16.0	£10.50
OM32320		18.0-17.0	£10.50
OM32321	19.0-18.0	£10.50	
OM32322	20.0-19.0	£10.50	

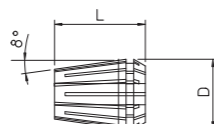

D	33mm
L	40mm
Clamping Range	1.0 - 20.0mm

ER40 COLLETS STANDARD



- Standard ER Collets
- (<10µ accuracy)
- Clamping Range 2.0 - 32.0mm

Part Number	Description	Clamping Size (mm)	Price
OM32351	ER40 Standard Collet (10 micron accuracy)	2.0-1.5	£12.50
OM32352		2.5-2.0	£12.50
OM32327		3.0-2.0	£6.50
OM32353		3.5-2.5	£10.50
OM32328		4.0-3.0	£6.50
OM32354		4.5-3.5	£10.50
OM32329		5.0-4.0	£6.50
OM32330		6.0-5.0	£6.50
OM32331		7.0-6.0	£6.50
OM32332		8.0-7.0	£6.50
OM32333		9.0-8.0	£6.50
OM32334		10.0-9.0	£6.50
OM32335		11.0-10.0	£6.50
OM32336		12.0-11.0	£6.50
OM32337		13.0-12.0	£6.50
OM32338		14.0-13.0	£6.50
OM32339		15.0-14.0	£6.50
OM32340		16.0-15.0	£6.50
OM32341		17.0-16.0	£6.50
OM32342		18.0-17.0	£6.50
OM32343		19.0-18.0	£6.50
OM32344		20.0-19.0	£6.50
OM32345		21.0-20.0	£6.50
OM32346		22.0-21.0	£6.50
OM32347		23.0-22.0	£6.50
OM32348		24.0-23.0	£6.50
OM32349		25.0-24.0	£6.50
OM32350		26.0-25.0	£6.50
OM33056*		27.0-26.8	£18.00
OM33057*		28.0-27.8	£18.00
OM33058*		29.0-28.8	£18.00
OM32355*		30.0-29.8	£18.00
OM33060*	31.0-30.8	£18.00	
OM32356*	32.0-31.8	£18.00	

* Collets over 26mm diameter have shorter L dimension

ER40 COLLETS ULTRA PRECISION



- Ultra Precision ER Collets
- (<5µ accuracy)
- Clamping Range 2.0 - 32.0mm

Part Number	Description	Clamping Size (mm)	Price
OM32387	ER40 Ultra Precision Collet (5 micron accuracy)	2.0-1.5	£20.00
OM32388		2.5-2.0	£20.00
OM32389		3.0-2.5	£16.80
OM32390		3.5-2.5	£16.80
OM32391		4.0-3.0	£13.50
OM32392		4.5-3.5	£13.50
OM32393		5.0-4.0	£13.50
OM32394		6.0-5.0	£13.50
OM32395		7.0-6.0	£13.50
OM32396		8.0-7.0	£13.50
OM32397		9.0-8.0	£13.50
OM32398		10.0-9.0	£13.50
OM32399		11.0-10.0	£13.50
OM32400		12.0-11.0	£13.50
OM32401		13.0-12.0	£13.50
OM32402		14.0-13.0	£13.50
OM32403		15.0-14.0	£13.50
OM32404		16.0-15.0	£13.50
OM32405		17.0-16.0	£13.50
OM32406		18.0-17.0	£13.50
OM32407		19.0-18.0	£13.50
OM32408		20.0-19.0	£13.50
OM32409		21.0-20.0	£13.50
OM32410		22.0-21.0	£13.50
OM32411		23.0-22.0	£13.50
OM32412		24.0-23.0	£13.50
OM32413		25.0-24.0	£13.50
OM32414		26.0-25.0	£13.50
OM32415*		30.0-29.8	£23.00
OM32416*		32.0-31.0	£23.00

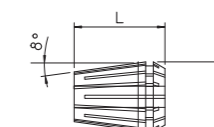

D	41mm
L	46mm
Clamping Range	2.0 - 26.0mm

ER50 COLLETS STANDARD

- Standard ER Collets
- (<10µ accuracy)
- Clamping Range 12.0 - 40.0mm

Part Number	Description	Clamping Size (mm)	Price
OM32420	ER50 Standard Collet (10 micron accuracy)	12.0-10.0	£20.00
OM32421		14.0-12.0	£20.00
OM32422		16.0-14.0	£20.00
OM32423		18.0-16.0	£20.00
OM32424		20.0-18.0	£20.00
OM32425		22.0-20.0	£20.00
OM32426		24.0-22.0	£20.00
OM32427		25.0-23.0	£20.00
OM32428		26.0-24.0	£20.00
OM32429		28.0-26.0	£20.00
OM32430		30.0-28.0	£20.00
OM32431		32.0-30.0	£20.00
OM32432		34.0-32.0	£20.00
OM33062*		36.0-35.8	£44.00
OM33063*		38.0-37.8	£44.00
OM33064*		40.0-38.8	£44.00

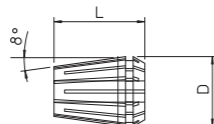

D	52mm
L	460mm
Clamping Range	12.0 - 34.0mm

* Collets over 34mm diameter have shorter L dimension



ER16 STANDARD SEALED COLLETS

- Rubber Seal
- (<10µ accuracy)
- Clamping Range 3-10mm

Part Number	Description	Clamping Size (mm)	Price
OM32462	ER16 Coolant Sealed Standard Collet (<10 micron accuracy)	3	£14.00
OM32463		4	£14.00
OM32464		5	£14.00
OM32465		6	£14.00
OM32466		7	£14.00
OM32467		8	£14.00
OM32468		9	£14.00
OM32469		10	£14.00



ER20 STANDARD SEALED COLLETS

- Rubber Seal
- (<10µ accuracy)
- Clamping Range 3-13mm

Part Number	Description	Clamping Size (mm)	Price
OM32489	ER20 Coolant Sealed Standard Collet (<10 micron accuracy)	3	£16.00
OM32490		4	£16.00
OM32491		5	£16.00
OM32492		6	£16.00
OM32493		7	£16.00
OM32494		8	£16.00
OM32495		9	£16.00
OM32496		10	£16.00
OM32497		11	£16.00
OM32498		12	£16.00
OM32499		13	£16.00



ER25 STANDARD SEALED COLLETS

- Rubber Seal
- (<10µ accuracy)
- Clamping Range 3-16mm



Part Number	Description	Clamping Size (mm)	Price
OM32525	ER25 Coolant Sealed Standard Collet (<10 micron accuracy)	3	£15.00
OM32526		4	£15.00
OM32527		5	£15.00
OM32528		6	£15.00
OM32529		7	£15.00
OM32530		8	£15.00
OM32531		9	£15.00
OM32532		10	£15.00
OM32533		11	£15.00
OM32534		12	£15.00
OM32535		13	£15.00
OM32536		14	£15.00
OM32537		15	£15.00
OM32538		16	£15.00

ER40 STANDARD SEALED COLLETS

- Rubber Seal
- (<10µ accuracy)
- Clamping Range 3-26mm



Part Number	Description	Clamping Size (mm)	Price
OM32627	ER40 Coolant Sealed Standard Collet (<10 micron accuracy)	3	£21.00
OM32628		4	£21.00
OM32629		5	£21.00
OM32630		6	£21.00
OM32631		7	£21.00
OM32632		8	£21.00
OM32633		9	£21.00
OM32634		10	£21.00
OM32635		11	£21.00
OM32636		12	£21.00
OM32637		13	£21.00
OM32638		14	£21.00
OM32639		15	£21.00
OM32640		16	£21.00
OM32641		17	£21.00
OM32642		18	£21.00
OM32643		19	£21.00
OM32644		20	£21.00
OM32645		21	£21.00
OM32646		22	£21.00
OM32647		23	£21.00
OM32648		24	£21.00
OM32649		25	£21.00
OM32650		26	£21.00

ER32 STANDARD SEALED COLLETS

- Rubber Seal
- (<10µ accuracy)
- Clamping Range 3-20mm



Part Number	Description	Clamping Size (mm)	Price
OM32570	ER32 Coolant Sealed Standard Collet (<10 micron accuracy)	3	£16.00
OM32571		4	£16.00
OM32572		5	£16.00
OM32573		6	£16.00
OM32574		7	£16.00
OM32575		8	£16.00
OM32576		9	£16.00
OM32577		10	£16.00
OM32578		11	£16.00
OM32579		12	£16.00
OM32580		13	£16.00
OM32581		14	£16.00
OM32582		15	£16.00
OM32583		16	£16.00
OM32584		17	£16.00
OM32585		18	£16.00
OM32586		19	£16.00
OM32587	20	£16.00	

ER COLLETS

ER COLLETS

ER11 HIGH PRESSURE SEALED COLLETS COOLANT SEALED COLLETS

- Integral Metal Seal for High Pressure Cooling - 120 bar
- (<10µ accuracy)
- Clamping Range 3-7mm



Part Number	Description	Clamping Size (mm)	Price
OM33604	ER11 High Pressure Coolant Sealed Collet (<10 micron accuracy)	3	£16.00
OM33605		4	£16.00
OM33606		4.5	£16.00
OM33607		5	£16.00
OM33608		5.5	£16.00
OM33609		6	£16.00
OM33610		6.5	£16.00
OM33611		7	£16.00

ER20 HIGH PRESSURE SEALED COLLETS COOLANT SEALED COLLETS

- Integral Metal Seal for High Pressure Cooling - 120 bar
- (<10µ accuracy)
- Clamping Range 3-13mm



Part Number	Description	Clamping Size (mm)	Price
OM33508	ER20 High Pressure Coolant Sealed Collet (<10 micron accuracy)	3	£20.00
OM33509		4	£20.00
OM33510		5	£20.00
OM33511		6	£20.00
OM33512		7	£20.00
OM33513		8	£20.00
OM33514		9	£20.00
OM33515		10	£20.00
OM33516		11	£20.00
OM33517		12	£20.00
OM33518		13	£20.00

ER16 HIGH PRESSURE SEALED COLLETS COOLANT SEALED COLLETS

- Integral Metal Seal for High Pressure Cooling - 120 bar
- (<10µ accuracy)
- Clamping Range 3-10mm



Part Number	Description	Clamping Size (mm)	Price
OM33500	ER16 High Pressure Coolant Sealed Collet (<10 micron accuracy)	3	£18.00
OM33501		4	£18.00
OM33502		5	£18.00
OM33503		6	£18.00
OM33504		7	£18.00
OM33505		8	£18.00
OM33506		9	£18.00
OM33507		10	£18.00

ER25 HIGH PRESSURE SEALED COLLETS COOLANT SEALED COLLETS

- Integral Metal Seal for High Pressure Cooling - 120 bar
- (<10µ accuracy)
- Clamping Range 3-16mm



Part Number	Description	Clamping Size (mm)	Price
OM33519	ER25 High Pressure Coolant Sealed Collet (<10 micron accuracy)	3	£20.00
OM33520		4	£20.00
OM33521		5	£20.00
OM33522		6	£20.00
OM33523		7	£20.00
OM33524		8	£20.00
OM33525		9	£20.00
OM33526		10	£20.00
OM33527		11	£20.00
OM33528		12	£20.00
OM33529		13	£20.00
OM33530		14	£20.00
OM33531		15	£20.00
OM33532		16	£20.00

ER32 HIGH PRESSURE SEALED COLLETS COOLANT SEALED COLLETS



- Integral Metal Seal for High Pressure Cooling - 120 bar
- (<10µ accuracy)
- Clamping Range 3-20mm

Part Number	Description	Clamping Size (mm)	Price
OM33533	ER32 High Pressure Coolant Sealed Collet (<10 micron accuracy)	3	£20.00
OM33534		4	£20.00
OM33535		5	£20.00
OM33536		6	£20.00
OM33537		7	£20.00
OM33538		8	£20.00
OM33539		9	£20.00
OM33540		10	£20.00
OM33541		11	£20.00
OM33542		12	£20.00
OM33543		13	£20.00
OM33544		14	£20.00
OM33545		15	£20.00
OM33546		16	£20.00
OM33547		17	£20.00
OM33548		18	£20.00
OM33549		19	£20.00
OM33550		20	£20.00

ER40 HIGH PRESSURE SEALED COLLETS COOLANT SEALED COLLETS



- Integral Metal Seal for High Pressure Cooling - 120 bar
- (<10µ accuracy)
- Clamping Range 3-26mm

Part Number	Description	Clamping Size (mm)	Price
OM33551	ER40 High Pressure Coolant Sealed Collet (<10 micron accuracy)	3	£27.00
OM33552		4	£27.00
OM33553		5	£27.00
OM33554		6	£27.00
OM33555		7	£27.00
OM33556		8	£27.00
OM33557		9	£27.00
OM33558		10	£27.00
OM33559		11	£27.00
OM33560		12	£27.00
OM33561		13	£27.00
OM33562		14	£27.00
OM33563		15	£27.00
OM33564		16	£27.00
OM33565		17	£27.00
OM33566		18	£27.00
OM33567		19	£27.00
OM33568		20	£27.00
OM33569		21	£27.00
OM33570		22	£27.00
OM33571		23	£27.00
OM33572		24	£27.00
OM33573		25	£27.00
OM33574		26	£27.00

ER16 JET COOLANT SEALED COLLETS COOLANT SEALED COLLETS

- <10µ accuracy
- Coolant channels on front face of collet
- For tools without through coolant
- Clamping Range 3-10mm



Part Number	Description	Clamping Size (mm)	Price
OM36300	ER16 Jet Coolant Collet (<10 micron accuracy)	3	£20.00
OM36301		4	£20.00
OM36302		5	£20.00
OM36303		6	£20.00
OM36304		7	£20.00
OM36305		8	£20.00
OM36306		9	£20.00
OM36307		10	£20.00

ER25 JET COOLANT SEALED COLLETS COOLANT SEALED COLLETS

- Coolant channels on front face of collet
- <10µ accuracy
- For tools without through coolant
- Clamping Range 3-16mm



Part Number	Description	Clamping Size (mm)	Price
OM36319	ER25 Jet Coolant Collet (<10 micron accuracy)	3	£22.00
OM36320		4	£22.00
OM36321		5	£22.00
OM36322		6	£22.00
OM36323		7	£22.00
OM36324		8	£22.00
OM36325		9	£22.00
OM36326		10	£22.00
OM36327		11	£22.00
OM36328		12	£22.00
OM36329		13	£22.00
OM36330		14	£22.00
OM36331		15	£22.00
OM36332		16	£22.00

ER20 JET COOLANT SEALED COLLETS COOLANT SEALED COLLETS

- Coolant channels on front face of collet
- <10µ accuracy
- For tools without through coolant
- Clamping Range 3-13mm



Part Number	Description	Clamping Size (mm)	Price
OM36308	ER20 Jet Coolant Collet (<10 micron accuracy)	3	£20.00
OM36309		4	£20.00
OM36310		5	£20.00
OM36311		6	£20.00
OM36312		7	£20.00
OM36313		8	£20.00
OM36314		9	£20.00
OM36315		10	£20.00
OM36316		11	£20.00
OM36317		12	£20.00
OM36318	13	£20.00	

ER32 JET COOLANT SEALED COLLETS COOLANT SEALED COLLETS

- Coolant channels on front face of collet
- (<10µ accuracy)
- For tools without through coolant
- Clamping Range 3-20mm



Part Number	Description	Clamping Size (mm)	Price
OM36333	ER32 Jet Coolant Collet (<10 micron accuracy)	3	£24.00
OM36334		4	£24.00
OM36335		5	£24.00
OM36336		6	£24.00
OM36337		7	£24.00
OM36338		8	£24.00
OM36339		9	£24.00
OM36340		10	£24.00
OM36341		11	£24.00
OM36342		12	£24.00
OM36343		13	£24.00
OM36344		14	£24.00
OM36345		15	£24.00
OM36346		16	£24.00
OM36347		17	£24.00
OM36348		18	£24.00
OM36349		19	£24.00
OM36350		20	£24.00

ER16 TAPPING COLLETS TAPPING COLLETS WITH SQUARE

- ($<10\mu$ accuracy)

Part Number	Description	Tap Shank (mm)	Square (mm)	Price
OM32903	ER16 Tapping Collet (<10 micron accuracy)	2.8	2.1	£17.00
OM32997		3	2.5	£17.00
OM32904		3.5	2.7	£17.00
OM32998		4	3	£17.00
OM32905		4	3.15/3.2	£17.00
OM32906		4.5	3.4	£17.00
OM32907		5	4	£17.00
OM32908		5.5	4.3	£17.00
OM33000		6	4.5	£17.00
OM32909		6	4.9	£17.00
OM32999		6.2	5	£17.00
OM32910		6.3	5	£17.00
OM32911		7	5.5	£17.00
OM32912		8	6.2/6.3	£17.00

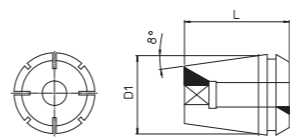

D	16.5mm
L	27.5mm

ER25 TAPPING COLLETS TAPPING COLLETS WITH SQUARE

- ($<10\mu$ accuracy)

Part Number	Description	Tap Shank (mm)	Square (mm)	Price
OM32939	ER25 Tapping Collet (<10 micron accuracy)	3.5	2.7	£18.00
OM33002		4	3	£18.00
OM32940		4	3.15/3.2	£18.00
OM32941		4.5	3.4	£18.00
OM32942		5	4	£18.00
OM32943		5.5	4.3	£18.00
OM33004		6	4.5	£18.00
OM32944		6	4.9	£18.00
OM33003		6.2	5	£18.00
OM32945		6.3	5	£18.00
OM32946		7	5.5	£18.00
OM32947		8	6.2/6.3	£18.00
OM33005		8.5	6.5	£18.00
OM32948		9	7.0/7.1	£18.00
OM32949		10	8	£18.00
OM33001		10.5	8	£18.00
OM32950		11	9	£18.00
OM32951		12	9	£18.00
OM32952		12.5	10	£18.00
OM32953		14	11.0/11.2	£18.00
OM32954		16	12	£18.00

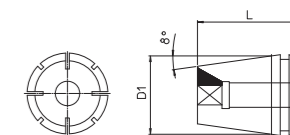

D	25.5mm
L	34mm

ER20 TAPPING COLLETS TAPPING COLLETS WITH SQUARE

- ($<10\mu$ accuracy)

Part Number	Description	Tap Shank (mm)	Square (mm)	Price
OM32913	ER20 Tapping Collet (<10 micron accuracy)	3.5	2.7	£18.00
OM32914		4	3.15/3.2	£18.00
OM32915		4.5	3.4	£18.00
OM32916		5	4	£18.00
OM32917		5.5	4.3	£18.00
OM32918		6	4.9	£18.00
OM32919		6.3	5	£18.00
OM32920		7	5.5	£18.00
OM32921		8	6.2/6.3	£18.00
OM32922		9	7.0/7.1	£18.00
OM32923		10	8	£18.00
OM32924		11	9	£18.00
OM32925		12	9	£18.00

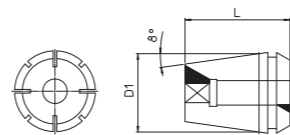

D	20.5mm
L	32.5mm

ER COLLETS

ER COLLETS

ER32 TAPPING COLLETS

TAPPING COLLETS WITH SQUARE

- (<10µ accuracy)

Part Number	Description	Tap Shank (mm)	Square (mm)	Price
OM32955	ER32 Tapping Collet (<10 micron accuracy)	3.5	2.7	£19.00
OM32956		4	3.15/3.2	£19.00
OM32957		4.5	3.4	£19.00
OM32958		5	4	£19.00
OM32959		5.5	4.3	£19.00
OM33007		6	4.5	£19.00
OM32960		6	4.9	£19.00
OM32961		6.3	5	£19.00
OM32962		7	5.5	£19.00
OM32963		8	6.2/6.3	£19.00
OM33008		8.5	6.5	£19.00
OM32964		9	7.0/7.1	£19.00
OM32965		10	8	£19.00
OM33006		10.5	8	£19.00
OM32966		11	9	£19.00
OM32967		12	9	£19.00
OM32968		12.5	10	£19.00
OM32969		14	11.0/11.2	£19.00
OM32970		16	12	£19.00
OM32971		18	14.0/14.5	£19.00
OM32972	20	16	£19.00	

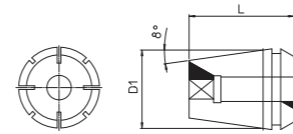

D	32.5mm
L	40mm

ER40 TAPPING COLLETS

TAPPING COLLETS WITH SQUARE

- (<10µ accuracy)

Part Number	Description	Tap Shank (mm)	Square (mm)	Price
OM32973	ER40 Tapping Collet (<10 micron accuracy)	4	3.15/3.2	£23.00
OM32974		4.5	3.4	£23.00
OM32975		5	4	£23.00
OM32976		5.5	4.3	£23.00
OM32977		6	4.9	£23.00
OM32978		6.3	5	£23.00
OM32979		7	5.5	£23.00
OM32980		8	6.2/6.3	£23.00
OM32981		9	7.0/7.1	£23.00
OM32982		10	8	£23.00
OM32983		11	9	£23.00
OM32984		12	9	£23.00
OM32985		12.5	10	£23.00
OM32986		14	11.0/11.2	£23.00
OM32987		16	12	£23.00
OM32988		18	14.0/14.5	£23.00
OM32989		20	16	£23.00
OM32990		22	18	£23.00
OM32991		25	20	£23.00

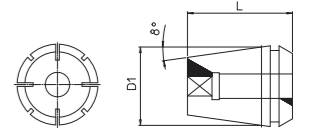

D	40.5mm
L	46mm

ER8 IMPERIAL COLLETS

CLAMPING RANGE 1/16 - 3/16

- (<10µ accuracy)

Part Number	Description	Clamping Size	Price
OM32702	ER8 Standard Collet (10 micron accuracy)	1/16"	£16.00
OM32703		1/8"	£13.00
OM32704		3/16"	£13.00



ER11 IMPERIAL COLLETS

CLAMPING RANGE 1/16 - 1/4

- (<10µ accuracy)

Part Number	Description	Clamping Size	Price
OM32711	ER11 Standard Collet (10 micron accuracy)	1/16"	£16.00
OM32712		1/8"	£12.00
OM32713		3/16"	£12.00
OM32714		1/4"	£12.00



ER16 IMPERIAL COLLETS

CLAMPING RANGE 1/16 - 3/8

- (<10µ accuracy)

Part Number	Description	Clamping Size	Price
OM32723	ER16 Standard Collet (10 micron accuracy)	1/16"	£13.00
OM32724		1/8"	£10.00
OM32725		3/16"	£10.00
OM32726		1/4"	£10.00
OM32727		5/16"	£10.00
OM32728		3/8"	£10.00



ER20 IMPERIAL COLLETS

CLAMPING RANGE 1/16 - 1/2

- (<10µ accuracy)

Part Number	Description	Clamping Size	Price
OM32741	ER20 Standard Collet (10 micron accuracy)	1/16"	£13.00
OM32742		1/8"	£10.00
OM32743		3/16"	£10.00
OM32744		1/4"	£10.00
OM32745		5/16"	£10.00
OM32746		3/8"	£10.00
OM32747		7/16"	£10.00
OM32748		1/2"	£10.00



ER25 IMPERIAL COLLETS

CLAMPING RANGE 1/16 - 5/8

- (<10µ accuracy)

Part Number	Description	Clamping Size	Price
OM32765	ER25 Standard Collet (10 micron accuracy)	1/16"	£14.00
OM32766		1/8"	£10.00
OM32767		3/16"	£10.00
OM32768		1/4"	£10.00
OM32769		5/16"	£10.00
OM32770		3/8"	£10.00
OM32771		7/16"	£10.00
OM32772		1/2"	£10.00
OM32773		9/16"	£10.00
OM32774		5/8"	£10.00



ER32 IMPERIAL COLLETS

CLAMPING RANGE 1/16 - 3/8

- (<10µ accuracy)

Part Number	Description	Clamping Size	Price
OM32795	ER32 Standard Collet (10 micron accuracy)	1/8"	£10.00
OM32796		3/16"	£10.00
OM32797		1/4"	£10.00
OM32798		5/16"	£10.00
OM32799		3/8"	£10.00
OM32800		7/16"	£10.00
OM32801		1/2"	£10.00
OM32802		9/16"	£10.00
OM32803		5/8"	£10.00
OM32804		11/16"	£10.00
OM32805	3/4"	£10.00	



ER8 COLLET SETS

Part Number	Description	Accuracy	Collet Range	Price
OM32027	ER8 Standard Set	<10 micron	1 - 5mm (9 pcs)	£78.00
OM32029	ER8 Ultra Precision Set	<5 micron	1 - 5mm (9 pcs)	£142.00



ER16 COLLET SETS

Part Number	Description	Accuracy	Collet Range	Price
OM32129	ER16 Standard Set	<10 micron	1 - 10mm (10 pcs)	£48.00
OM32131	ER16 Ultra Precision Set	<5 micron	1 - 10mm (10 pcs)	£102.00
OM32486	ER16 Standard Sealed Set	<10 micron	3 - 10mm (8 pcs)	£112.00
OM33575	ER16 High Pressure Sealed Set	<10 micron	3 - 10mm (8 pcs)	£140.00
OM32992	ER16 Tapping Collet Set	<10 micron	(10 pcs)	£174.00



ER11 COLLET SETS

Part Number	Description	Accuracy	Collet Range	Price
OM32069	ER11 Standard Set	<10 micron	1 - 7mm (13 pcs)	£82.00
OM32071	ER11 Ultra Precision Set	<5 micron	1 - 7mm (13 pcs)	£152.00
OM33612	ER11 High Pressure Sealed Set	<10 micron	3 - 7mm (8 pcs)	£120.00



ER20 COLLET SETS

Part Number	Description	Accuracy	Collet Range	Price
OM32183	ER20 Standard Set	<10 micron	2 - 13mm (12 pcs)	£68.00
OM32185	ER20 Ultra Precision Set	<5 micron	2 - 13mm (12 pcs)	£134.00
OM32522	ER20 Standard Sealed Set	<10 micron	3 - 13mm (11 pcs)	£174.00
OM33576	ER20 High Pressure Sealed Set	<10 micron	3 - 13mm (11 pcs)	£209.00
OM32993	ER20 Tapping Collet Set	<10 micron	(13 pcs)	£224.00



ER25 COLLET SETS

Part Number	Description	Accuracy	Collet Range	Price
OM32246	ER25 Standard Set	<10 micron	2 - 16mm (15 pcs)	£75.00
OM32248	ER25 Ultra Precision Set	<5 micron	2 - 16mm (15 pcs)	£154.00
OM32567	ER25 Standard Sealed Set	<10 micron	3 - 16mm (14 pcs)	£206.00
OM33577	ER25 High Pressure Sealed Set	<10 micron	3 - 16mm (14 pcs)	£265.00
OM32994	ER25 Tapping Collet Set	<10 micron	(15 pcs)	£264.00



ER40 COLLET SETS

Part Number	Description	Accuracy	Collet Range	Price
OM32417	ER40 Standard Set	<10 micron	4 - 26mm (23 pcs)	£121.00
OM32419	ER40 Ultra Precision Set	<5 micron	4 - 26mm (23 pcs)	£272.00
OM32699	ER40 Standard Sealed Set	<10 micron	3 - 25mm (19 pcs)	£364.00
OM33579	ER40 High Pressure Sealed Set	<10 micron	3 - 25mm (19 pcs)	£449.00
OM32996	ER40 Tapping Collet Set	<10 micron	(19 pcs)	£432.00



ER32 COLLET SETS

Part Number	Description	Accuracy	Collet Range	Price
OM32324	ER32 Standard Set	<10 micron	3 - 20mm (18 pcs)	£82.00
OM32326	ER32 Ultra Precision Set	<5 micron	3 - 20mm (18 pcs)	£192.00
OM32624	ER32 Standard Sealed Set	<10 micron	3 - 20mm (18 pcs)	£260.00
OM33578	ER32 High Pressure Sealed Set	<10 micron	3 - 20mm (18 pcs)	£325.00
OM32995	ER32 Tapping Collet Set	<10 micron	(18 pcs)	£344.00



ER50 COLLET SETS

Part Number	Description	Accuracy	Collet Range	Price
OM32459	ER50 Standard Set	<10 micron	12 - 34mm (12 pcs)	£244.00



ER COLLETS

ER COLLETS

OZ 12 COLLETS

Standard Collets



- (<10µ accuracy)
- Clamping Range 1.0 - 12.0mm

Part Number	Description	Clamping Size (mm)	Price
OM33580	OZ 12 Standard Collets (<10µ accuracy)	1	£18.00
OM33581		1.5	£18.00
OM33582		2	£18.00
OM33583		2.5	£18.00
OM33584		3	£18.00
OM33585		3.5	£18.00
OM33586		4	£18.00
OM33587		4.5	£18.00
OM33588		5	£18.00
OM33589		5.5	£18.00
OM33590		6	£18.00
OM33591		6.5	£18.00
OM33592	7	£18.00	
OM33593	7.5	£18.00	
OM33594	8	£18.00	
OM33595	8.5	£18.00	
OM33596	9	£18.00	
OM33597	9.5	£18.00	
OM33598	10	£18.00	
OM33599	10.5	£18.00	
OM33600	11	£18.00	
OM33601	11.5	£18.00	
OM33602	12	£18.00	

OZ 16 COLLETS

Standard Collets



- (<10µ accuracy)
- Clamping Range 2.0 - 16.0mm

Part Number	Description	Clamping Size (mm)	Price
OM30476	OZ 16 Standard Collets (<10µ accuracy)	2	£16.00
OM30477		3	£16.00
OM30478		4	£16.00
OM30479		5	£16.00
OM30480		6	£16.00
OM30481		7	£16.00
OM30482		8	£16.00
OM30483		9	£16.00
OM30484		10	£16.00
OM30485		11	£16.00
OM30486		12	£16.00
OM30487		13	£16.00
OM30488		14	£16.00
OM30489		15	£16.00
OM30490		16	£16.00

OZ 25 COLLETS

Standard Collets



- (<10µ accuracy)
- Clamping Range 2.0 - 25.0mm

Part Number	Description	Clamping Size (mm)	Price
OM31574	OZ 25 Standard Collets (<10µ accuracy)	2	£15.00
OM31575		3	£15.00
OM31576		4	£15.00
OM31577		5	£15.00
OM31578		6	£15.00
OM31579		7	£15.00
OM31580		8	£15.00
OM31581		9	£15.00
OM31582		10	£15.00
OM31583		11	£15.00
OM31584		12	£15.00
OM31585		13	£15.00
OM31586		14	£15.00
OM31587		15	£15.00
OM31588		16	£15.00
OM31589		17	£15.00
OM31590		18	£15.00
OM31591		19	£15.00
OM31592		20	£15.00
OM31593		21	£15.00
OM31594		22	£15.00
OM31595		23	£15.00
OM31596		24	£15.00
OM31597		25	£15.00

OZ 32 COLLETS

Standard Collets



- (<10µ accuracy)
- Clamping Range 3.0 - 32.0mm

Part Number	Description	Clamping Size (mm)	Price
OM31598	OZ 32 Standard Collets (<10µ accuracy)	3	£18.00
OM31599		4	£18.00
OM31600		5	£18.00
OM31601		6	£18.00
OM31602		7	£18.00
OM31603		8	£18.00
OM31604		9	£18.00
OM31605		10	£18.00
OM31606		11	£18.00
OM31607		12	£18.00
OM31608		13	£18.00
OM31609		14	£18.00
OM31610		15	£18.00
OM31611		16	£18.00
OM31612		17	£18.00
OM31613		18	£18.00
OM31614		19	£18.00
OM31615		20	£18.00
OM31616		21	£18.00
OM31617		22	£18.00
OM31618		23	£18.00
OM31619		24	£18.00
OM31620		25	£18.00
OM31621		26	£18.00
OM31622		27	£18.00
OM31623		28	£18.00
OM31624		29	£18.00
OM31625		30	£18.00
OM31626		31	£18.00
OM31627		32	£18.00

OZ COLLETS

OZ COLLETS

GSK 06 COLLETS

Ultra Precision Collets



- (5μ accuracy)
- Clamping Range 1.0 - 6.0mm

Part Number	Clamping Size (d)	Price
OM30500	1	£16.00
OM30501	1.5	£16.00
OM30502	2	£16.00
OM30503	2.5	£16.00
OM30504	3	£16.00
OM30505	3.5	£16.00
OM30506	4	£16.00
OM30507	4.5	£16.00
OM30508	5	£16.00
OM30509	5.5	£16.00
OM30510	6	£16.00

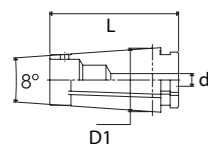

D	10mm
L	24.6mm
Clamping Range	1.0 - 6.0mm

GSK 10 COLLETS

Ultra Precision Collets



- (5μ accuracy)
- Clamping Range 1.0 - 10.0mm

Part Number	Clamping Size (d)	Price
OM30511	1	£16.00
OM30512	1.5	£16.00
OM30513	2	£16.00
OM30514	2.5	£16.00
OM30515	3	£16.00
OM30516	3.5	£16.00
OM30517	4	£16.00
OM30518	4.5	£16.00
OM30519	5	£16.00
OM30520	5.5	£16.00
OM30521	6	£16.00
OM30522	6.5	£16.00
OM30523	7	£16.00
OM30524	7.5	£16.00
OM30525	8	£16.00
OM30526	8.5	£16.00
OM30527	9	£16.00
OM30528	9.5	£16.00
OM30529	10	£16.00

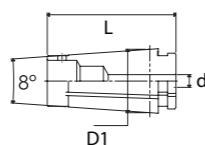

D	15.5mm
L	30.5mm
Clamping Range	1.0 - 10.0mm

GSK 16 COLLETS

Ultra Precision Collets



- (5μ accuracy)
- Clamping Range 1.0 - 16.0mm

Part Number	Clamping Size (d)	Price
OM30530	1	£18.00
OM30531	1.5	£18.00
OM30532	2	£18.00
OM30533	2.5	£18.00
OM30534	3	£18.00
OM30535	3.5	£18.00
OM30536	4	£18.00
OM30537	4.5	£18.00
OM30538	5	£18.00
OM30539	5.5	£18.00
OM30540	6	£18.00
OM30541	6.5	£18.00
OM30542	7	£18.00
OM30543	7.5	£18.00
OM30544	8	£18.00
OM30545	8.5	£18.00
OM30546	9	£18.00
OM30547	9.5	£18.00
OM30548	10	£18.00
OM30549	10.5	£18.00
OM30550	11	£18.00
OM30551	11.5	£18.00
OM30552	12	£18.00
OM30553	12.5	£18.00
OM30554	13	£18.00
OM30555	13.5	£18.00
OM30556	14	£18.00
OM30557	14.5	£18.00
OM30558	15	£18.00
OM30559	15.5	£18.00
OM30560	16	£18.00

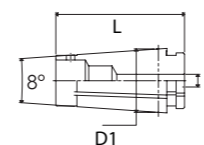

D	24.6mm
L	45mm
Clamping Range	1.0 - 16.0mm

GSK 25 COLLETS

Ultra Precision Collets



- (5μ accuracy)
- Clamping Range 1.0 - 25.0mm

Part Number	Clamping Size (d)	Price
OM30561	1	£22.00
OM30562	1.5	£22.00
OM30563	2	£22.00
OM30564	2.5	£22.00
OM30565	3	£22.00
OM30566	3.5	£22.00
OM30567	4	£22.00
OM30568	4.5	£22.00
OM30569	5	£22.00
OM30570	5.5	£22.00
OM30571	6	£22.00
OM30572	6.5	£22.00
OM30573	7	£22.00
OM30574	7.5	£22.00
OM30575	8	£22.00
OM30576	8.5	£22.00
OM30577	9	£22.00
OM30578	9.5	£22.00
OM30579	10	£22.00
OM30580	10.5	£22.00
OM30581	11	£22.00
OM30582	11.5	£22.00
OM30583	12	£22.00
OM30584	12.5	£22.00
OM30585	13	£22.00
OM30586	13.5	£22.00
OM30587	14	£22.00
OM30588	14.5	£22.00
OM30589	15	£22.00
OM30590	15.5	£22.00
OM30591	16	£22.00
OM30592	16.5	£22.00
OM30593	17	£22.00
OM30594	17.5	£22.00
OM30595	18	£22.00
OM30596	18.5	£22.00
OM30597	19	£22.00
OM30598	19.5	£22.00
OM30599	20	£22.00
OM30600	20.5	£22.00
OM30601	21	£22.00
OM30602	21.5	£22.00
OM30603	22	£22.00
OM30604	22.5	£22.00
OM30605	23	£22.00
OM30606	23.5	£22.00
OM30607	24	£22.00
OM30608	24.5	£22.00
OM30609	25	£22.00

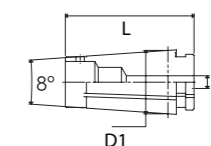

D	35mm
L	57mm
Clamping Range	1.0 - 16.0mm

GSK COLLETS

GSK COLLETS

DMC COLLETS

Ultra Precision Draw Back Collets

- (<5µ accuracy)
- Clamping Range 2.0 - 10.0mm

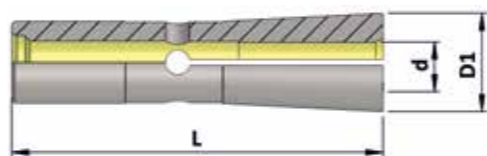

Part Number	Description	Dimensions (mm)			Price
		Clamping Size (d)	D1	L	
OM30722	DMC 06	2	9.6	36	£29.00
OM30723		3	9.6	36	£29.00
OM30724		4	9.6	36	£29.00
OM30725		5	9.6	36	£29.00
OM30726		6	9.6	36	£29.00
OM30728	DMC 08	3	15	45	£29.00
OM30729		4	15	45	£29.00
OM30731		6	15	45	£29.00
OM30733		8	15	45	£29.00
OM33676	DMC 10	4	19.1	52	£29.00
OM33677		6	19.1	52	£29.00
OM33678		8	19.1	52	£29.00
OM33679		10	19.1	52	£29.00

HYDRAULIC REDUCTION SLEEVES

RS Sealed Sleeves for Hydraulic Expansion Chucks & Premium Power Milling Chucks

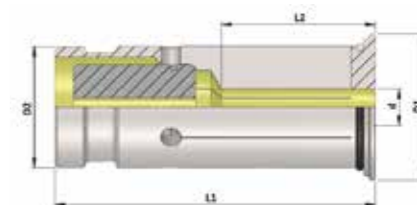

- Concentricity 0.005mm
- Wire cut slots to ensure no leakage & maximum accuracy

Part Number	Description	Dimensions (mm)					Price
		d	D1	D2	L1	L2	
OM32214	RS SEAL 12	3	16.5	12	48	15	£44.00
OM32215		4	16.5	12	48	14	£44.00
OM32216		5	16.5	12	48	18	£44.00
OM32217		6	16.5	12	48	25	£44.00
OM32218		8	16.5	12	48	26	£44.00
OM32219	RS SEAL 20	3	29	20	52.5	14	£45.00
OM32220		4	29	20	52.5	15	£45.00
OM32221		5	29	20	52.5	18	£45.00
OM32222		6	29	20	52.5	25	£45.00
OM32223		7	29	20	52.5	25	£45.00
OM32224		8	29	20	52.5	30	£45.00
OM32225		9	29	20	52.5	30	£45.00
OM32274		10	29	20	52.5	33	£45.00
OM32275		11	29	20	52.5	33	£45.00
OM32276		12	29	20	52.5	34	£45.00
OM32277		13	29	20	52.5	34	£45.00
OM32278		14	29	20	52.5	34	£45.00
OM32279		15	29	20	52.5	40	£45.00
OM32280		16	29	20	52.5	40	£45.00
OM32281		RS SEAL 32	6	39	32	63.5	25
OM32282	8		39	32	63.5	25	£48.00
OM32283	10		39	32	63.5	33	£48.00
OM32284	12		39	32	63.5	34	£48.00
OM32285	14		39	32	63.5	34	£48.00
OM32286	16		39	32	63.5	40	£48.00
OM32287	18		39	32	63.5	40	£48.00
OM32288	20		39	32	63.5	40	£48.00
OM32289	25		39	32	63.5	42	£48.00



STRAIGHT SHANK COLLETS

For Power Milling Chucks



Part Number	Description	Outside Dia (mm)	Clamping Size (mm)	Price
OM33009	SC20 Straight Shank Collet	20	6	£18.00
OM33010			8	£18.00
OM33011			10	£18.00
OM33012			12	£18.00
OM33013			16	£18.00
OM33014	SC25 Straight Shank Collet	25	6	£18.00
OM33015			8	£18.00
OM33016			10	£18.00
OM33017			12	£18.00
OM33018			16	£18.00
OM33019	SC32 Straight Shank Collet	32	20	£18.00
OM33020			6	£18.00
OM33021			8	£18.00
OM33022			10	£18.00
OM33023			12	£18.00
OM33024			16	£18.00
OM33025			20	£18.00
OM33026	25	£18.00		

QUICK CHANGE ER TAPPING COLLETS

QCTC-ER16 Rigid Collets

- Quick Release System
- No Compression & No Expansion
- Recommended for use with MLC Synchro Tapping Chucks

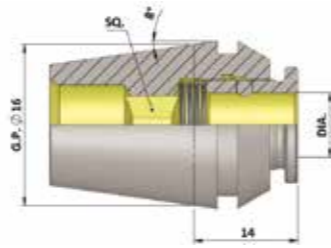

As per (ISO) (529-1975) Standards

Part Number	Description	Dia	Square	Price
OM32542	QCTC ER16 (ISO)	3.15	2.50	£20.00
OM32543		3.55	2.80	£20.00
OM32544		4.00	3.15	£20.00
OM32545		4.50	3.55	£20.00
OM32546		5.00	4.00	£20.00
OM32547		5.60	4.50	£20.00
OM32548		6.30	5.00	£20.00

As per (DIN) Standards

Part Number	Description	Dia	Square	Price
OM32549	QCTC ER16 (DIN)	3.50	2.70	£20.00
OM32550		4.00	3.00	£20.00
OM32551		4.50	3.40	£20.00
OM32552		6.00	4.90	£20.00

As per (JIS) Standards

Part Number	Description	Dia	Square	Price
OM32550	QCTC ER16 (JIS)	4.00	3.00	£20.00
OM32568		4.00	3.20	£20.00
OM32546		5.00	4.00	£20.00
OM33098		5.50	4.50	£20.00
OM32588		6.00	4.50	£20.00
OM32589		6.10	5.00	£20.00
OM32590		6.20	5.00	£20.00

QUICK CHANGE ER TAPPING COLLETS

QCTC-ER20 Rigid Collets

- Quick Release System
- No Compression & No Expansion
- Recommended for use with MLC Synchro Tapping Chucks

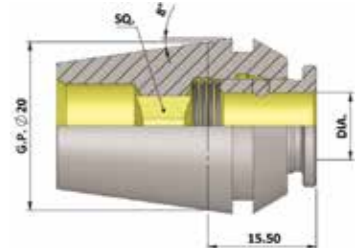

As per (ISO) (529-1975) Standards

Part Number	Description	Dia	Square	Price
OM32591	QCTC ER20 (ISO)	3.15	2.50	£20.00
OM32592		3.55	2.80	£20.00
OM32593		4.00	3.15	£20.00
OM32594		4.50	3.55	£20.00
OM32595		5.00	4.00	£20.00
OM32596		5.60	4.50	£20.00
OM32597		6.30	5.00	£20.00
OM32598		7.10	5.60	£20.00

As per (DIN) Standards

Part Number	Description	Dia	Square	Price
OM32599	QCTC ER20 (DIN)	3.50	2.70	£20.00
OM32600		4.00	3.00	£20.00
OM32601		4.50	3.40	£20.00
OM32602		6.00	4.90	£20.00
OM32603		7.00	5.5	£20.00

As per (JIS) Standards

Part Number	Description	Dia	Square	Price
OM32600	QCTC ER20 (JIS)	4.00	3.00	£20.00
OM32604		4.00	3.20	£20.00
OM32595		5.00	4.00	£20.00
OM32605		5.50	4.50	£20.00
OM32625		6.00	4.50	£20.00
OM32651		6.10	5.00	£20.00
OM32652		6.20	5.00	£20.00
OM32603		7.00	5.50	£20.00

QUICK CHANGE TAPPING COLLETS

QUICK CHANGE TAPPING COLLETS

QUICK CHANGE ER TAPPING COLLETS

QCTC-ER25 Rigid Collets

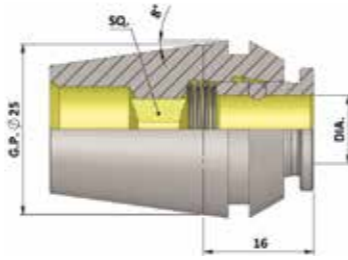

- Quick Release System
- No Compression & No Expansion
- Recommended for use with MLC Synchro Tapping Chucks

As per (ISO) (529-1975) Standards

Part Number	Description	Dia	Square	Price
OM32653	QCTC ER25 (ISO)	3.15	2.50	£22.00
OM32654		3.55	2.80	£22.00
OM32655		4.00	3.15	£22.00
OM32656		4.50	3.55	£22.00
OM32657		5.00	4.00	£22.00
OM32658		5.60	4.50	£22.00
OM32659		6.30	5.00	£22.00
OM32660		7.10	5.60	£22.00
OM32661		8.00	6.30	£22.00
OM32662		9.00	7.10	£22.00
OM32663		10.00	8.00	£22.00



As per (DIN) Standards

Part Number	Description	Dia	Square	Price
OM32664	QCTC ER25 (DIN)	3.50	2.70	£22.00
OM32665		4.00	3.00	£22.00
OM32666		4.50	3.40	£22.00
OM32667		6.00	4.90	£22.00
OM32668		7.00	5.50	£22.00
OM32705		8.00	6.20	£22.00
OM32669		9.00	7.00	£22.00
OM32663	10.00	8.00	£22.00	

As per (JIS) Standards

Part Number	Description	Dia	Square	Price
OM32665	QCTC ER25 (JIS)	4.00	3.00	£22.00
OM32670		4.00	3.20	£22.00
OM32657		5.00	4.00	£22.00
OM32671		5.50	4.50	£22.00
OM32672		6.00	4.50	£22.00
OM32673		6.10	5.00	£22.00
OM32674		6.20	5.00	£22.00
OM32668		7.00	5.50	£22.00
OM32700		8.00	6.00	£22.00
OM32705		8.00	6.20	£22.00
OM32706		8.50	6.50	£22.00
OM32669		9.00	7.00	£22.00

QUICK CHANGE ER TAPPING COLLETS

QCTC-ER32 Rigid Collets

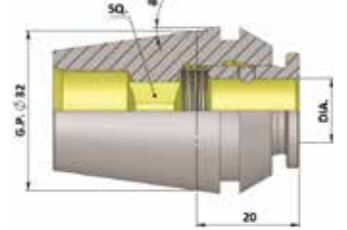

- Quick Release System
- No Compression & No Expansion
- Recommended for use with MLC Synchro Tapping Chucks

As per (ISO) (529-1975) Standards

Part Number	Description	Dia	Square	Price
OM32707	QCTC ER32 (ISO)	3.15	2.50	£24.00
OM32715		3.55	2.80	£24.00
OM32716		4.00	3.15	£24.00
OM32717		4.50	3.55	£24.00
OM32718		5.00	4.00	£24.00
OM32729		5.60	4.50	£24.00
OM32730		6.30	5.00	£24.00
OM32731		7.10	5.60	£24.00
OM32732		8.00	6.30	£24.00
OM32733		9.00	7.10	£24.00
OM32734		10.00	8.00	£24.00
OM32749		11.20	9.00	£24.00
OM32750		12.50	10.00	£24.00
OM32751		14.00	11.20	£24.00



As per (DIN) Standards

Part Number	Description	Dia	Square	Price
OM32752	QCTC ER32 (DIN)	3.50	2.70	£24.00
OM32753		4.00	3.00	£24.00
OM32754		4.50	3.40	£24.00
OM32755		6.00	4.90	£24.00
OM32756		7.00	5.50	£24.00
OM32775		8.00	6.20	£24.00
OM32776		9.00	7.00	£24.00
OM32734		10.00	8.00	£24.00
OM32777		11.00	9.00	£24.00
OM32778		12.00	9.00	£24.00
OM32779		14.00	11.00	£24.00

As per (JIS) Standards

Part Number	Description	Dia	Square	Price
OM32753	QCTC ER32 (JIS)	4.00	3.00	£24.00
OM32780		4.00	3.20	£24.00
OM32718		5.00	4.00	£24.00
OM32781		5.50	4.50	£24.00
OM32782		6.00	4.50	£24.00
OM32783		6.10	5.00	£24.00
OM32784		6.20	5.00	£24.00
OM32756		7.00	5.50	£24.00
OM32806		8.00	6.00	£24.00
OM32775		8.00	6.20	£24.00
OM32807		8.50	6.50	£24.00
OM32776		9.00	7.00	£24.00
OM32808		10.50	8.00	£24.00
OM32777		11.00	9.00	£24.00
OM32778		12.00	9.00	£24.00
OM32750		12.50	10.00	£24.00
OM32779		14.00	11.00	£24.00

QUICK CHANGE TAPPING COLLETS

QUICK CHANGE TAPPING COLLETS

QUICK CHANGE ER TAPPING COLLETS

QCTC-ER40 Rigid Collets

- Quick Release System
- No Compression & No Expansion
- Recommended for use with MLC Synchro Tapping Chucks

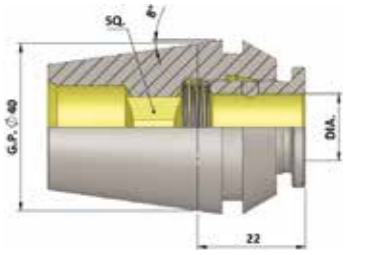
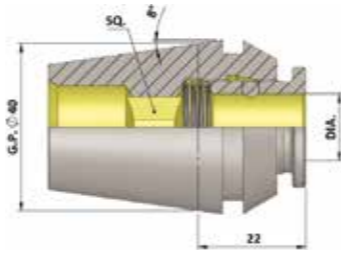

As per (ISO) (529-1975) Standards

Part Number	Description	Dia	Square	Price
OM32809	QCTC ER40 (ISO)	3.15	2.50	£27.00
OM32810		3.55	2.80	£27.00
OM32811		4.00	3.15	£27.00
OM32812		4.50	3.55	£27.00
OM32813		5.00	4.00	£27.00
OM32814		5.60	4.50	£27.00
OM32815		6.30	5.00	£27.00
OM32816		7.10	5.60	£27.00
OM32853		8.00	6.30	£27.00
OM32854		9.00	7.10	£27.00
OM32855		10.00	8.00	£27.00
OM32856		11.20	9.00	£27.00
OM32857		12.50	10.00	£27.00
OM32858		14.00	11.20	£27.00
OM32859		16.00	12.50	£27.00
OM32860		18.00	14.00	£27.00

As per (JIS) Standards

Part Number	Description	Dia	Square	Price
OM32862	QCTC ER40 (JIS)	4.00	3.00	£27.00
OM32872		4.00	3.20	£27.00
OM32813		5.00	4.00	£27.00
OM32873		5.50	4.50	£27.00
OM32874		6.00	4.50	£27.00
OM32875		6.10	5.00	£27.00
OM32876		6.20	5.00	£27.00
OM32865		7.00	5.50	£27.00
OM32877		8.00	6.00	£27.00
OM32866		8.00	6.20	£27.00
OM33059		8.50	6.50	£27.00
OM32854		9.00	7.00	£27.00
OM33061		10.50	8.00	£27.00
OM32867		11.00	9.00	£27.00
OM32868		12.00	9.00	£27.00
OM32857		12.50	10.00	£27.00
OM33092		13.00	10.00	£27.00
OM32869		14.00	11.00	£27.00
OM33094		15.00	12.00	£27.00
OM32870		16.00	12.00	£27.00
OM32860	18.00	14.00	£27.00	

As per (DIN) Standards

Part Number	Description	Dia	Square	Price
OM32861	QCTC ER40 (DIN)	3.50	2.70	£27.00
OM32862		4.00	3.00	£27.00
OM32863		4.50	3.40	£27.00
OM32864		6.00	4.90	£27.00
OM32865		7.00	5.50	£27.00
OM32866		8.00	6.20	£27.00
OM32854		9.00	7.00	£27.00
OM32855		10.00	8.00	£27.00
OM32867		11.00	9.00	£27.00
OM32868		12.00	9.00	£27.00
OM32869		14.00	11.00	£27.00
OM32870		16.00	12.00	£27.00
OM32871		18.00	14.50	£27.00

QUICK CHANGE TAPPING COLLETS

QUICK CHANGE TAPPING COLLETS

QUICK CHANGE TAP ADAPTORS WITH CLUTCH

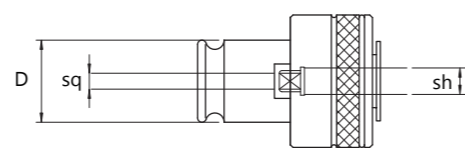

- For Tension & Compression Tapping Chucks
- Tapping Range M2 - M36

Part Number	Description	Thread	Tap Shank (mm)	Tap Square (mm)	D (mm)	List Price
OM30200	Size 1 Tap adaptor with Clutch (FES1)	M2	2.8	2.1	19	£35.00
OM30201		M3	3.5	2.7		£35.00
OM30202		M3.5	4	3		£35.00
OM30203		M4	4.5	3.4		£35.00
OM30204		M5	6	4.9		£35.00
OM30205		M6	6	4.9		£35.00
OM30206		M8	8	6.3		£35.00
OM30207		M10	10	8		£35.00
OM30208		M12	9	7		£35.00
OM30209		Size 2 Tap adaptor with Clutch (FES2)	M6	6		4.9
OM30210	M8		8	6.2	£46.00	
OM30211	M10		10	8	£46.00	
OM30212	M12		9	7	£46.00	
OM30213	M14		11	9	£46.00	
OM30214	M16		12	9	£46.00	
OM30215	M18		14	11	£46.00	
OM30216	M20		16	12	£46.00	
OM30217	Size 3 Tap adaptor with Clutch (FES3)	M14	11	9	48	£67.00
OM30218		M16	12	9		£67.00
OM30219		M18	14	11		£67.00
OM30220		M20	16	12		£67.00
OM30221		M22	18	14.5		£67.00
OM30222		M24	18	14.5		£67.00
OM30223		M27	20	16		£67.00
OM30224		M30	22	18		£67.00
OM30225		M33	25	20		£67.00
OM30226		M36	28	22		£67.00

QUICK CHANGE TAP ADAPTORS WITHOUT CLUTCH

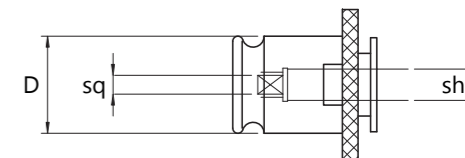

- For Tension & Compression Tapping Chucks
- Tapping Range M2 - M36

Part Number	Description	Thread	Tap Shank (mm)	Tap Square (mm)	D (mm)	List Price
OM30227	Size 1 Tap adaptor without Clutch (FE1)	M2	2.8	2.1	19	£16.00
OM30228		M3	3.5	2.7		£16.00
OM30229		M4	4.5	3.4		£16.00
OM30230		M5/M6	6	4.9		£16.00
OM30231		M8	8	6.2		£16.00
OM30232		M10	10	8		£16.00
OM30233		M12	9	7		£16.00
OM30234	Size 2 Tap adaptor without Clutch (FE2)	M5/M6	6	4.9	31	£21.00
OM30235		M8	8	6.2		£21.00
OM30236		M10	10	8		£21.00
OM30237		M12	9	7		£21.00
OM30238		M14	11	9		£21.00
OM30239		M16	12	9		£21.00
OM30240		M18	14	11		£21.00
OM30241	Size 3 Tap adaptor without Clutch (FE3)	M20	16	12	48	£21.00
OM30242		M14	11	9		£43.00
OM30243		M16	12	9		£43.00
OM30244		M18	14	11		£43.00
OM30245		M20	16	12		£43.00
OM30246		M24	18	14.5		£43.00
OM30247		M27	20	16		£43.00
OM30248		M30	22	18		£43.00
OM30249		M33	25	20		£43.00
OM30250	M36	28	22	£43.00		

With Clutch:

- Helps reduce broken taps
- Improved thread quality
- Taps & adaptors cannot slip in chuck
- Adjustable clutch control
- Recommended for high value workpieces and materials that are difficult to tap



Without Clutch:

- Lower Cost
- Improved thread quality
- Taps & adaptors cannot slip in chuck
- No clutch control
- Recommended for lower value workpieces



BORING HEADS

- High Rigidity & Precision
- 0.01mm Graduation
- Wide range of boring diameters and depths
- 1.1/2x18TPI Thread



Part Number	Description	Head Dia (mm)	Height (mm)	Bar Dia (mm)	Graduation (mm)	Range (mm)	Price
OM31433	F1-12 12mm Boring Head	50	61.6	12	0.01	10-125	£82.00
OM31434	F1-18 18mm Boring Head	75	80.2	18	0.01	12-225	£162.00
OM31435	F1-25 25mm Boring Head	100	93.2	25	0.01	15-320	£242.00

12MM AXIAL / RADIAL 4 PIECE BORING BAR SET

- For F1-12 Boring Head
- 4 Bar Set includes all bars listed below (OM01010)

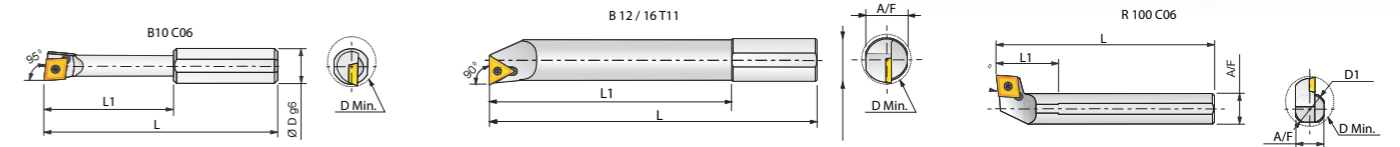

Part Number	Description	Dimensions (mm)					Insert	Price
		D1	D Min	L	L1	A/F		
OM01100	B10 C06	12	10	85	50	11	CCMT 0602	£32.00
OM01101	B12 T11	12	12	95	60	11	TCMT 1102	£32.00
OM01102	B16 T11	12	16	105	70	11	TCMT 1102	£32.00
OM01103	R100 C06	12	26	72	22	11	CCMT 0602	£32.00
OM01010	4 Bar 12mm Set for Boring Head	-	-	-	-	-	-	£94.00

BORING HEAD ADAPTORS

- For Mounting Boring Heads
- Common Mounting Thread 1.1/2 x 18 TPI

Part Number	Description	Price
OM31061	BT40 F1	£44.00
OM31134	BT50 F1	£66.00
OM31192	DV40 F1	£44.00
OM31531	DV50 F1	£66.00
OM30795	HSK63A F1	£115.00
OM31967	DIN2080 30 F1	£44.00
OM31563	DIN2080 40 F1	£44.00
OM31990	DIN2080 50 F1	£66.00
OM31317	R8 F1	£38.00
OM30370	MT4 F1	£36.00



18MM AXIAL / RADIAL 5 PIECE BORING BAR SET

- For F1-18 Boring Head
- 5 Bar Set includes all bars listed below (OM01011)

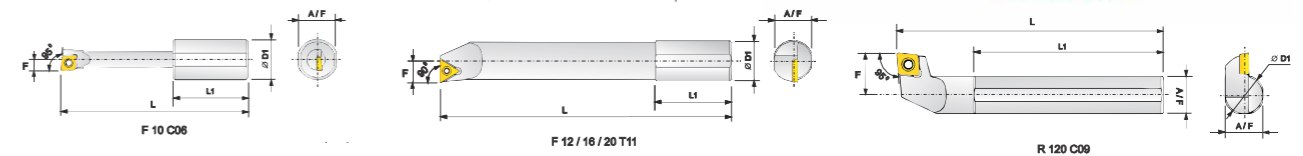

Part Number	Description	Dimensions (mm)					Insert	Price
		D1	D Min	L	L1	A/F		
OM01104	F10 C06	18	10	85	50	17	CCMT 0602	£32.00
OM01105	F12 T11	18	12	95	60	17	TCMT 1102	£32.00
OM01106	F16 T11	18	16	105	70	17	TCMT 1102	£32.00
OM01107	F20 T11	18	20	135	100	17	TCMT 1102	£32.00
OM01108	R120 C09	18	38	123	35	17	CCMT 09T3	£32.00
OM01011	5 Bar 18mm Set for Boring Head	-	-	-	-	-	-	£125.00

BORING HEADS & KITS

BORING HEADS & KITS

25MM AXIAL / RADIAL 5 PIECE BORING BAR SET

- For F1-25 Boring Head
- 5 Bar Set includes all bars listed below (OM01012)

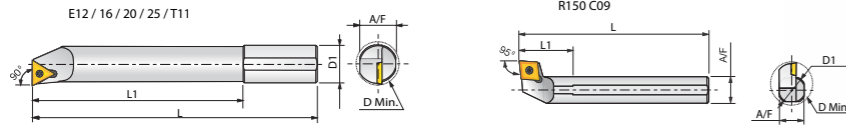

Part Number	Description	Dimensions (mm)					Insert	Price
		D1	D Min	L	L1	A/F		
OM01109	E12 T11	25	12	95	60	23.5	TCMT 1102	£41.00
OM01110	E16 T11	25	16	105	70	23.5	TCMT 1102	£41.00
OM01111	E20 T11	25	20	135	100	23.5	TCMT 1102	£41.00
OM01112	E25 T11	25	25	160	125	23.5	TCMT 1102	£41.00
OM01113	R150 C09	25	44	134	35	23.5	CCMT 09T3	£41.00
OM01012	5 Bar 25mm Set for Boring Head	-	-	-	-	-	-	£187.00

BORING BAR SLEEVES

- Reduction Sleeves
- Hardened & Ground
- Form A = Slotted
- Form B = Grub Screw

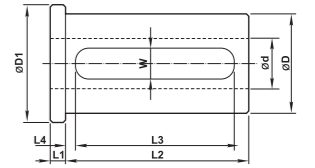

Form A



Part Number	Description	Dimensions (mm)									Price
		D (OD)	d (ID)	D1	L1	L2	L3	L4	W	Form	
OM20200	BBB 16 / 08 / 45	16	8	22	5	40	-	-	-	B	£13.00
OM20201	BBB 16 / 10 / 45		10	22	5	40	32	3	7	A	£13.00
OM20202	BBB 20 / 08 / 55	20	8	26	5	50	-	-	-	B	£14.00
OM20203	BBB 20 / 10 / 55		10	26	5	50	-	-	-	B	£14.00
OM20204	BBB 20 / 12 / 55	20	12	26	5	50	42	3	9	A	£14.00
OM19184	BBB 25 / 06 / 55		6	32	5	50	-	-	-	B	£16.00
OM20205	BBB 25 / 08 / 55	25	8	32	5	50	-	-	-	B	£16.00
OM20206	BBB 25 / 10 / 55		10	32	5	50	-	-	-	B	£16.00
OM20207	BBB 25 / 12 / 55	25	12	32	5	50	-	-	-	B	£16.00
OM19188	BBB 25 / 14 / 55		14	32	5	50	42	3	10	A	£16.00
OM20208	BBB 25 / 16 / 55	25	16	32	5	50	42	3	10	A	£16.00
OM19190	BBB 25 / 18 / 55		18	32	5	50	42	3	10	A	£16.00
OM19191	BBB 25 / 20 / 55	25	20	32	5	50	42	3	10	A	£16.00
OM19193	BBB 32 / 06 / 65		6	38	5	60	-	-	-	B	£18.00
OM20209	BBB 32 / 08 / 65	32	8	38	5	60	-	-	-	B	£18.00
OM20210	BBB 32 / 10 / 65		10	38	5	60	-	-	-	B	£18.00
OM20211	BBB 32 / 12 / 65	32	12	38	5	60	-	-	-	B	£18.00
OM20212	BBB 32 / 16 / 65		16	38	5	60	52	3	10	A	£18.00
OM20213	BBB 32 / 20 / 65	32	20	38	5	60	52	3	10	A	£18.00
OM20214	BBB 32 / 25 / 65		25	38	5	60	52	3	10	A	£18.00
OM20109	BBB 40 / 06 / 90	40	6	48	5	85	-	-	-	B	£20.00
OM20215	BBB 40 / 08 / 90		8	48	5	85	-	-	-	B	£20.00
OM20216	BBB 40 / 10 / 90	40	10	48	5	85	-	-	-	B	£20.00
OM20217	BBB 40 / 12 / 90		12	48	5	85	-	-	-	B	£20.00
OM20218	BBB 40 / 16 / 90	40	16	48	5	85	77	2	12	A	£20.00
OM20219	BBB 40 / 20 / 90		20	48	5	85	77	2	12	A	£20.00
OM20220	BBB 40 / 25 / 90	40	25	48	5	85	77	2	12	A	£20.00
OM20221	BBB 40 / 32 / 90		32	48	5	85	77	2	12	A	£20.00
OM20222	BBB 50 / 16 / 100	50	16	58	8	92	80	4	12	A	£59.00
OM20223	BBB 50 / 20 / 100		20	58	8	92	80	4	12	A	£59.00
OM20224	BBB 50 / 25 / 100	50	25	58	8	92	80	4	12	A	£59.00
OM20225	BBB 50 / 32 / 100		32	58	8	92	80	4	12	A	£59.00
OM20226	BBB 50 / 40 / 100	40	58	8	92	80	4	12	A	£59.00	

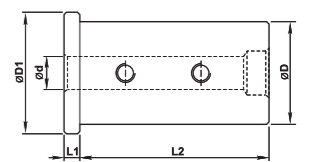

Form B



BORING HEADS & KITS

BORING BAR SLEEVES

BORING BAR REDUCTION SLEEVES SM E

- For VDI Tool Holders
- Sleeves for E1 & E2 types of Smaller Tools

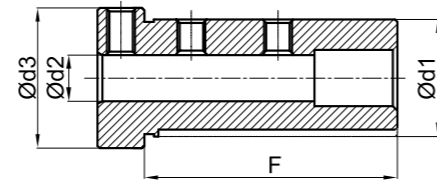

Part Number	Description	Dimensions (mm)				Price
		d1	d2	d3	F	
OM33253	SM E 20 08	20	8	25	39	£28.00
OM33254	SM E 20 10		10			£28.00
OM33255	SM E 25 08	25	8	30	50	£29.00
OM33256	SM E 25 10		10			£29.00
OM33257	SM E 25 12		12			£29.00
OM33258	SM E 32 08	32	8	37	59	£31.00
OM33259	SM E 32 10		10			£31.00
OM33260	SM E 32 12		12			£31.00
OM33261	SM E 32 16		16			£31.00
OM33262	SM E 40 08	40	8	45	69	£36.00
OM33263	SM E 40 10		10			£36.00
OM33264	SM E 40 12		12			£36.00
OM33265	SM E 40 16		16			£36.00
OM33266	SM E 40 20	20	£36.00			
OM33267	SM E 50 08	50	8	55	80	£42.00
OM33268	SM E 50 10		10			£42.00
OM33269	SM E 50 12		12			£42.00
OM33270	SM E 50 16		16			£42.00
OM33271	SM E 50 20		20			£42.00

BORING BAR REDUCTION SLEEVES SM E1

- For VDI Tool Holders
- Sleeves for E1 types of Bigger Tools

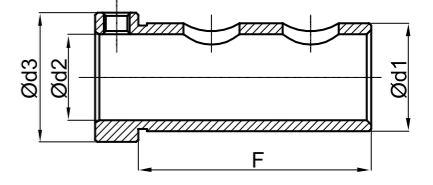

Part Number	Description	Dimensions (mm)				Price
		d1	d2	d3	F	
OM33272	SM E1 20 12	20	12	25	52	£27.00
OM33273	SM E1 20 16		16			£27.00
OM33274	SM E1 25 16	25	16	30	50	£28.00
OM33275	SM E1 25 20		20			£28.00
OM33276	SM E1 32 20	32	20	37	59	£30.00
OM33277	SM E1 32 25		25			£30.00
OM33278	SM E1 40 25	40	25	45	69	£34.00
OM33279	SM E1 40 32		32			£34.00
OM33280	SM E1 50 25	50	25	55	80	£42.00
OM33281	SM E1 50 32		32			£42.00
OM33282	SM E1 50 40		40			£42.00

BORING BAR REDUCTION SLEEVES SM E2

- For VDI Tool Holders
- Sleeves for E2 types of Bigger Tools

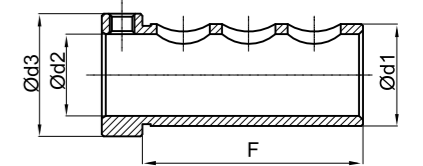

Part Number	Description	Dimensions (mm)				Price		
		d1	d2	d3	F			
OM33283	SM E2 20 12 L39	20	12	25	39	£27.00		
OM33284	SM E2 20 12 L52				52	£27.00		
OM33285	SM E2 20 16 L39				16	52	39	£27.00
OM33286	SM E2 20 16 L52						52	£27.00
OM33287	SM E2 25 16	25	16	30	50	£28.00		
OM33288	SM E2 25 20		20			£28.00		
OM33289	SM E2 32 20	32	20	37	59	£30.00		
OM33290	SM E2 32 25		25			£30.00		
OM33291	SM E2 40 25	40	25	45	69	£34.00		
OM33292	SM E2 40 32		32			£34.00		
OM33293	SM E2 50 25	50	25	55	80	£42.00		
OM33294	SM E2 50 32		32			£42.00		
OM33295	SM E2 50 40		40			£42.00		

BORING BAR SLEEVES

BORING BAR SLEEVES

ER COLLET CHUCKS

- Morse Taper (DIN228)
- Standard ER Collet System



Part Number	Description	Morse Taper	Collet Size	Price
OM30329	MT2 ER16 Collet Chuck	2	ER16	£42.00
OM30469	MT2 ER25 Collet Chuck		ER25	£45.00
OM30399	MT2 ER32 Collet Chuck		ER32	£48.00
OM30470	MT3 ER16 Collet Chuck	3	ER16	£42.00
OM30471	MT3 ER25 Collet Chuck		ER25	£45.00
OM30397	MT3 ER32 Collet Chuck		ER32	£48.00
OM30264	MT3 ER40 Collet Chuck	4	ER40	£62.00
OM30472	MT4 ER25 Collet Chuck		ER25	£45.00
OM30473	MT4 ER32 Collet Chuck		ER32	£48.00
OM30474	MT4 ER40 Collet Chuck	5	ER40	£62.00
OM30330	MT5 ER32 Collet Chuck		ER32	£72.00
OM30328	MT5 ER40 Collet Chuck		ER40	£76.00
OM30310	MT5 ER50 Collet Chuck		ER50	£85.00

REDUCTION SLEEVES Morse Taper (DIN228)

Part Number	Description	External Taper (K)	Internal Taper (K)	Length (L)	Price
OM30049	Morse Taper Reduction Sleeve	MT 1	MT 0	85	£7.00
OM30050		MT 2	MT 1	92	£7.00
OM30051		MT 3	MT 1	99	£7.00
OM30052			MT 2	112	£7.00
OM30053		MT 4	MT 1	124	£11.00
OM30054			MT 2	124	£11.00
OM30055			MT 3	140	£11.00
OM30056		MT 5	MT 1	156	£21.00
OM30057			MT 2	156	£21.00
OM30058			MT 3	156	£21.00
OM30059			MT 4	174	£21.00
OM30060		MT 6	MT 1	218	£42.00
OM30061			MT 2	218	£42.00
OM30062			MT 3	218	£42.00
OM30063			MT 4	218	£42.00
OM30064			MT 5	218	£42.00

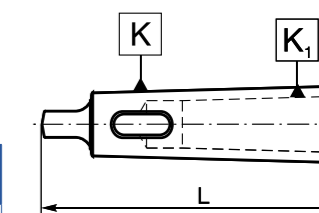

STRAIGHT SHANK TO MORSE TAPER ADAPTORS

- Turret Sockets



Part Number	Outside Dia (mm)	Internal Morse Taper	Length (mm)	Price
OM20227	25	MT 1	80	£21.00
OM20228		MT 2	92	£21.00
OM20229	32	MT 1	76	£21.00
OM20230		MT 2	75	£21.00
OM20231	40	MT 3	95	£21.00
OM20232		MT 1	90	£31.00
OM20233		MT 2	90	£31.00
OM20234	40	MT 3	95	£31.00
OM20235		MT 4	142	£31.00
OM20236	50	MT 1	100	£52.00
OM20237		MT 2	100	£52.00
OM20238		MT 3	115	£52.00
OM20239		MT 4	142	£52.00

EXTENSION SLEEVES Morse Taper (DIN228)

Part Number	Description	External Taper (K)	Internal Taper (K1)	Length (L)	Price
OM30065	Morse Taper Extension Sleeve	MT 1	MT 1	145	£14.00
OM30066			MT 2	160	£16.00
OM30067			MT 3	183	£21.00
OM30068		MT 2	MT 1	160	£16.00
OM30069			MT 2	175	£17.00
OM30070			MT 3	196	£21.00
OM30071		MT 3	MT 4	221	£39.00
OM30072			MT 1	175	£19.00
OM30073			MT 2	194	£20.00
OM30074			MT 3	215	£21.00
OM30075		MT 4	MT 4	240	£30.00
OM30076			MT 1	200	£27.00
OM30077			MT 2	215	£30.00
OM30078			MT 3	240	£32.00
OM30079			MT 4	265	£34.00
OM30080		MT 5	MT 5	300	£57.00
OM30081			MT 1	232	£49.00
OM30082			MT 2	247	£50.00
OM30083			MT 3	268	£52.00
OM30084			MT 4	300	£54.00
OM30085		MT 5	335	£66.00	

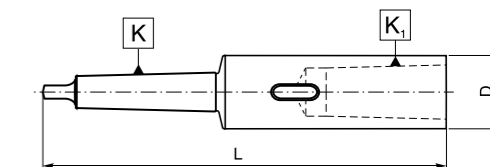

MORSE TAPER DRILL CHUCKS

- Morse Taper (DIN228)
- Keyless drill chuck can be tightened with wrench
- APU Spanner Pg. 217

Part Number	Description	Morse Taper	Capacity	Price
OM30398	MT3 APU13 - 1-13mm	MT 3	1-13mm	£60.00
OM30775	MT4 APU13 - 1-13mm	MT 4	1-13mm	£60.00



HEXAGON KEY DRILL CHUCKS

- High Accuracy Drill Chuck
- Strong Clamping Force in both clockwise & anti-clockwise operations
- Increased wear-resistance with Titanium Jaws
- Spare Hex Key – Pg. 217

Part Number	Description	Capacity (mm)	Taper Mount	Length (mm)		Price
				Open	Closed	
OM33670	GHK 13S JT6	0.3-13	JT6	95	105	£94.00
OM33671	GHK 13S B16	0.3-13	B16	95	105	£94.00
OM33672	GHK 16S JT6	1.5-16	JT6	104	115	£104.00
OM33673	GHK 16S B16	1.5-16	B16	104	115	£104.00



APU KEYLESS DRILL CHUCKS

- For Mounting on Short Taper Arbors
- 0 - 25µ Accuracy
- APU Spanner – Pg. 217

Part Number	Description	Capacity	Mount	Price
OM31436	B16 J0113A	1-13mm	B16	£49.00
OM31437	JT6 J0213A		JT6	£49.00
OM31438	B16 J0116A	3-16mm	B16	£49.00
OM31439	JT6 J0216		JT6	£49.00



MORSE TAPER DRILL CHUCK ARBORS MT - JT6 & B16

Part Number	Description	Morse Taper	Price
OM30086	JT6 Morse Taper Adaptors	MT 1	£6.00
OM30087		MT 2	£6.00
OM30088		MT 3	£8.00
OM30089		MT 4	£11.00
OM30090		MT 5	£16.00
OM30091	B16 Morse Taper Adaptors	MT 1	£6.00
OM30092		MT 2	£6.00
OM30093		MT 3	£8.00
OM30094		MT 4	£11.00
OM30095		MT 5	£16.00



TIGHTENING FIXTURES TWIN POT STYLE

- BT Tightening Fixtures also hold DIN2080, in the vertical position only

Part Number	Size / Type	Price
OM31025	BT30	£67.00
OM31099	BT40	£67.00
OM31169	BT50	£98.00
OM31360	DV30 / DIN30	£67.00
OM31217	DV40 / DIN40	£67.00
OM31256	DV50 / DIN50	£98.00



TIGHTENING FIXTURES BALL BEARING SINGLE POT STYLE

Part Number	Size / Type	Price
OM30282	HSK50, C5, DV30	£104.00
OM31482	BT30	£104.00
OM31451	BT40, HSK63, C6	£104.00
OM31483	DV40	£104.00
OM31069	BT50, HSK100	£149.00



BT (MAS) Solid Pull Studs

- Pull Studs without O-Ring
- Solid Without Through Coolant

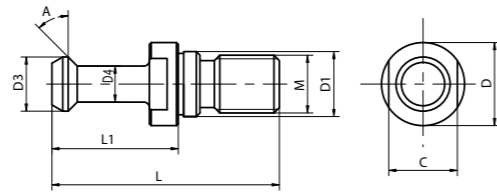

Part Number	ISO	A	M	Dimensions (mm)							Price
				L1	L	D	D1	D3	D4	C	
OM30100	30	45°	M12	23	43	16	12.5	11	7	13	£5.30
OM30102		60°		23	43	16	12.5	11	7	13	£5.30
OM30104	40	45°	M16	35	60	23	17	15	10	19	£5.30
OM30106		60°		35	60	23	17	15	10	19	£5.30
OM30108		90°		35	60	23	17	15	10	19	£5.30
OM30110	50	45°	M24	45	85	38	25	23	17	30	£7.80
OM30112		60°		45	85	38	25	23	17	30	£7.80
OM30114		90°		45	85	38	25	23	17	30	£7.80



BT (MAS) Hollow Pull Studs

- Pull Studs without O-Ring
- Hollow for Through Coolant

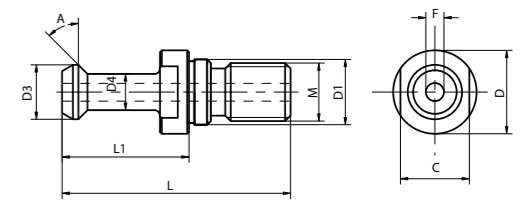

Part Number	ISO	A	M	Dimensions (mm)								Price
				L1	L	D	D1	D3	D4	C	F	
OM30101	30	45°	M12	23	43	16	12.5	11	7	13	3	£5.80
OM30103		60°		23	43	16	12.5	11	7	13	3	£5.80
OM30105	40	45°	M16	35	60	23	17	15	10	19	4	£5.80
OM30107		60°		35	60	23	17	15	10	19	4	£5.80
OM30109		90°		35	60	23	17	15	10	19	4	£5.80
OM30111	50	45°	M24	45	85	38	25	23	17	30	6	£8.80
OM30113		60°		45	85	38	25	23	17	30	6	£8.80
OM30115		90°		45	85	38	25	23	17	30	6	£8.80



BT (MAS) Solid Pull Studs

- Pull Studs with O-Ring
- Solid Without Through Coolant

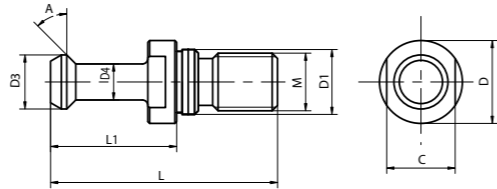

Part Number	ISO	A	M	Dimensions (mm)							Price
				L1	L	D	D1	D3	D4	C	
OM30150	40	45°	M16	35	60	23	17	15	10	19	£5.80
OM30151		60°		35	60	23	17	15	10	19	£5.80
OM30152		90°		35	60	23	17	15	10	19	£5.80
OM30153	50	45°	M24	45	85	38	25	23	17	30	£8.80
OM30154		60°		45	85	38	25	23	17	30	£8.80
OM30155		90°		45	85	38	25	23	17	30	£8.80



BT (MAS) Hollow Pull Studs

- Pull Studs with O-Ring
- Hollow for Through Coolant

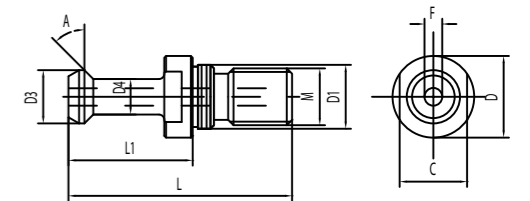

Part Number	ISO	A	M	Dimensions (mm)								Price
				L1	L	D	D1	D3	D4	C	F	
OM30148	30	45°	M12	23	43	16	12.5	11	7	13	3	£6.20
OM30149		60°		23	43	16	12.5	11	7	13	3	£6.20
OM30141	40	45°	M16	35	60	23	17	15	10	19	4	£6.20
OM30142		60°		35	60	23	17	15	10	19	4	£6.20
OM30143		90°		35	60	23	17	15	10	19	4	£6.20
OM30144	50	45°	M24	45	85	38	25	23	17	30	6	£9.30
OM30145		60°		45	85	38	25	23	17	30	6	£9.30
OM30146		90°		45	85	38	25	23	17	30	6	£9.30



DIN 69872 B Solid Pull Studs

- Pull Studs without O-Ring
- Solid Without Through Coolant

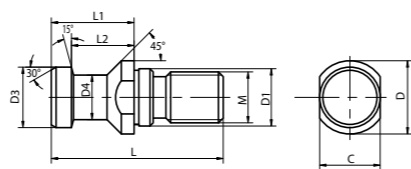

Part Number	ISO	M	Dimensions (mm)								Price
			D	D1	D3	D4	L	L1	L2	C	
OM30166	30	M12	17	13	13	9	44	24	19	14	£5.30
OM30118	40	M16	23	17	19	14	54	26	20	19	£5.80
OM30120	50	M24	36	25	28	21	74	34	25	30	£8.40

DIN 69872 B Solid Pull Studs

- Pull Studs with O-Ring
- Solid Without Through Coolant

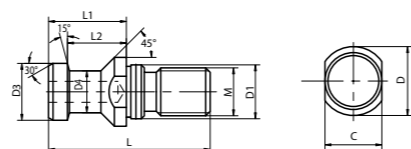

Part Number	ISO	M	Dimensions (mm)								Price
			D	D1	D3	D4	L	L1	L2	C	
OM30157	40	M16	23	17	19	14	54	26	20	19	£6.20
OM30158	50	M24	36	25	28	21	74	34	25	30	£8.80

DIN 69872 A Hollow Pull Studs

- Pull Studs without O-Ring
- Hollow for Through Coolant

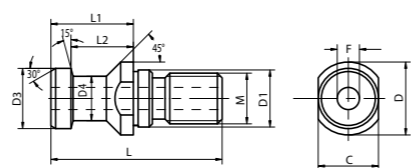

Part Number	ISO	M	Dimensions (mm)								Price	
			D	D1	D3	D4	L	L1	L2	C		
OM30116	30	M12	17	13	13	9	44	24	19	14	4	£6.20
OM30117	40	M16	23	17	19	14	54	26	20	19	7	£6.20
OM30119	50	M24	36	25	28	21	74	34	25	30	11.5	£8.80

DIN 69872 A Hollow Pull Studs

- Pull Studs with O-Ring
- Hollow for Through Coolant
- OM17055 is similar to DIN 69872 A, but 3mm longer

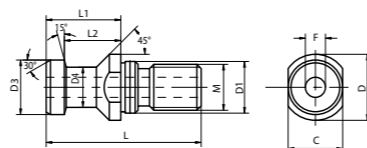

Part Number	ISO	M	Dimensions (mm)								Price	
			D	D1	D3	D4	L	L1	L2	C		
OM30132	40	M16	23	17	19	14	54	26	20	19	7	£7.30
OM17055	40	M16	23	17	19	14	54	29	23	19	7	£9.00
OM30133	50	M24	36	25	28	21	74	34	25	30	11.5	£9.80

ISO 7388/2-A Hollow Pull Studs

- Hollow for Through Coolant
- Without O-Ring

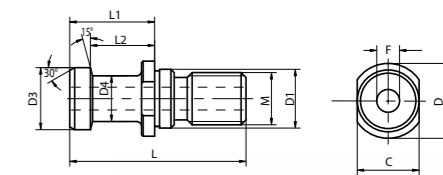

Part Number	ISO	M	Dimensions (mm)								Price	
			D	D1	D3	D4	L	L1	L2	C		
OM30121	40	M16	23	17	19	14	54	26	20	19	7	£6.20
OM30122	50	M24	36	25	28	21	74	34	25	30	11.5	£8.40

ISO 7388/2-A Hollow Pull Studs

- Hollow for Through Coolant
- With O-Ring

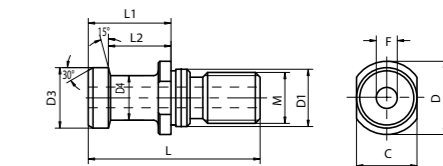

Part Number	ISO	M	Dimensions (mm)								Price	
			D	D1	D3	D4	L	L1	L2	C		
OM30160	40	M16	23	17	19	14	54	26	20	19	7	£7.30
OM30161	50	M24	36	25	28	21	74	34	25	30	11.5	£9.30

ISO 7388/2-B Solid Pull Studs

- Solid Without Through Coolant
- With O-Ring

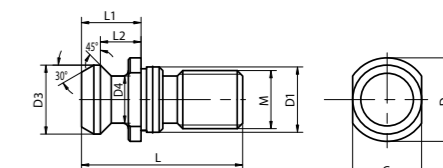

Part Number	ISO	M	Dimensions (mm)								Price
			D	D1	D3	D4	L	L1	L2	C	
OM30167	40	M16	22.5	17	18.9	12.9	44.5	16.4	11.2	18	£6.20
OM30168	50	M24	37	25	29.1	19.6	65.5	25.5	17.9	30	£8.40

ISO 7388/2-B Hollow Pull Studs

- Hollow for Through Coolant
- Without O-Ring

Part Number	ISO	M	Dimensions (mm)									Price
			D	D1	D3	D4	L	L1	L2	C	f	
OM30123	40	M16	22.5	17	18.9	12.9	44.5	16.4	11.2	18	7.3	£6.20
OM30124	50	M24	37	25	29.1	19.6	65.5	25.5	17.9	30	11.5	£8.40

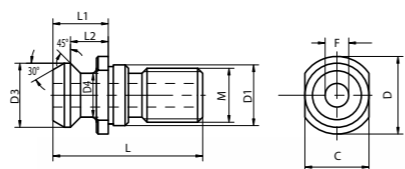

JIS. B6339 Hollow Pull Studs

- Hollow for Through Coolant
- Without O-Ring

Part Number	ISO	A	M	Dimensions (mm)								Price
				D	D1	D3	D4	L	L1	C	f	
OM30125	40	15°	M16	23	17	19	14	54	29	19	7	£7.50
OM30126	50	15°	M24	38	25	28	21	74	34	30	10	£11.50

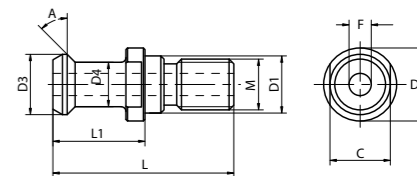

ISO 7388/2-B Hollow Pull Studs

- Hollow for Through Coolant
- With O-Ring

Part Number	ISO	M	Dimensions (mm)									Price
			D	D1	D3	D4	L	L1	L2	C	f	
OM30135	40	M16	22.5	17	18.9	12.9	44.5	16.4	11.2	18	7.3	£7.30
OM30159	50	M24	37	25	29.1	19.6	65.5	25.5	17.9	30	11.5	£9.30

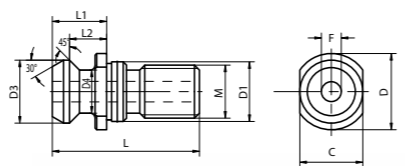

JIS. B6339 Hollow Pull Studs

- Hollow for Through Coolant
- With O-Ring

Part Number	ISO	A	M	Dimensions (mm)								Price
				D	D1	D3	D4	L	L1	C	f	
OM30162	40	15°	M16	23	17	19	14	54	29	19	7	£8.40
OM30163	50	15°	M24	38	25	28	21	74	34	30	10	£12.50

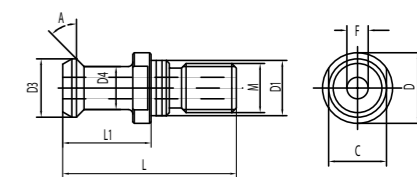

DIN 2080 Pull Stud Adaptors

- With Internal Thread and Hole Through

Part Number	ISO	M	Dimensions (mm)					Price
			d	D	D1	L	L1	
OM16980	DV40	M16	M16	25.3	17	53	25	£12.00
OM30169	BT40	M16	M16	25.3	17	56	28	£12.00
OM18434	50	M25	M24	39.6	25	65	25	£13.50

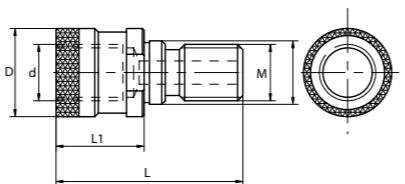

Mazak Pull Studs

- Hollow for Through Coolant
- Without O-Ring

Part Number	ISO	M	Dimensions (mm)								Price
			D	D1	D3	D4	L	L1	C	f	
OM30129	40	M16	21.8	17	18.79	12.44	41.25	16.25	11.17	7	£9.30
OM30130	40	M16	22	17	18.79	12.44	44.1	19.1	14.02	7	£9.30
OM30131	50	M24	37	25	28.95	20.8	65.2	25.2	17.58	10	£11.50
OM30499	50	M24	35.5	25	28.95	20.8	65.4	25.4	17.78	10	£11.50

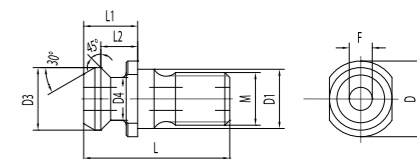

Mazak Pull Studs

- Hollow for Through Coolant
- With O-Ring

Part Number	ISO	M	Dimensions (mm)								Price
			D	D1	D3	D4	L	L1	C	f	
OM30164	40	M16	21.8	17	18.79	12.44	41.25	16.25	11.17	7	£9.80
OM30165	40	M16	22	17	18.79	12.44	44.1	19.1	14.02	7	£9.80

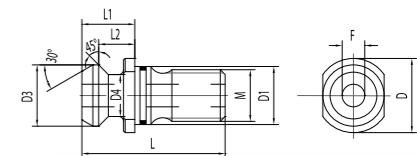

HAAS Pull Studs

- Hollow for Through Coolant
- Similar to JIS B 6399 (MAS 403 BT), 3mm shorter
- Without O-Ring

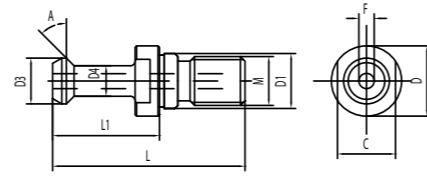

Part Number	ISO	A	M	Dimensions (mm)								Price
				L1	L	D	D1	D3	D4	C	F	
OM30134	40	45°	M16	32	57	23	17	15	10	19	7	£6.20

HAAS Pull Studs

- Hollow for Through Coolant
- Similar to JIS B 6399 (MAS 403 BT), 3mm shorter
- With O-Ring

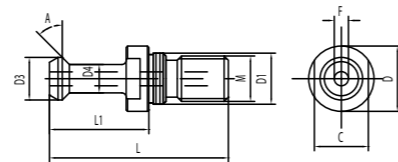

Part Number	ISO	A	M	Dimensions (mm)								Price
				L1	L	D	D1	D3	D4	C	F	
OM30156	40	45°	M16	32	57	23	17	15	10	19	7	£7.30

CINCINNATI Pull Studs

- Hollow for Through Coolant
- Without O-Ring

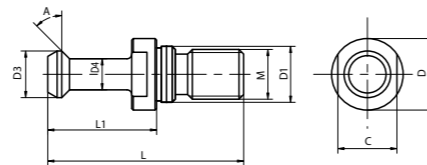

Part Number	ISO	M	Dimensions (mm)							Price
			D	D1	D3	D4	L	L1	C	
OM30127	40	M16	22.2	17	15	10.3	67.3	39.4	19	£9.80
OM30128	40	M16	22.2	17	15	10.3	64.3	36.6	18	£9.80

SPECIAL PULL STUDS

- Any pull stud can be identified and manufactured to specific requirements, with the following information:

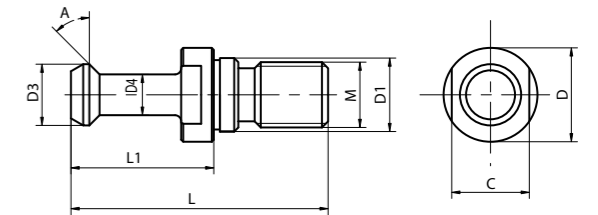

A =	
L =	
L1 =	
D =	
D1 =	
D3 =	
D4 =	
C =	
M =	
Through Coolant?	

A1° =	
A2° =	
L =	
L1 =	
L2 =	
D =	
D1 =	
D3 =	
D4 =	
C =	
M =	
F =	
Through Coolant?	

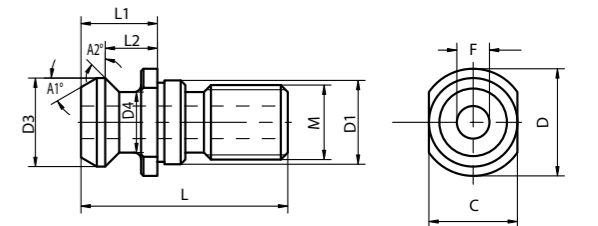

L =	
L1 =	
L2 =	
D =	
D1 =	
D3 =	
D4 =	
C =	
M =	
Through Coolant?	

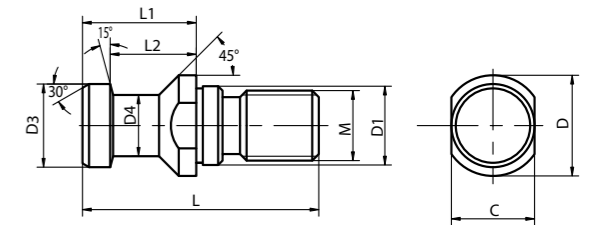

Mini Collet Nuts

- ER Collet Nuts for Mini Chucks

Part Number	Collet	Nut Type	Nut Diameter (mm)	Price
OM31418	ER8	Mini Collet Nut (GMT)	12	£9.50
OM31414	ER11		16	£9.50
OM31415	ER16		22	£9.50
OM31416	ER20		28	£9.50
OM31417	ER25		35	£9.50



ER Hexagon Collet Nuts

Part Number	Collet	Nut Type	Nut Diameter (mm)	Price
OM31425	ER11	Hex Collet Nut (GSX)	19	£9.50
OM31426	ER16		28	£9.50
OM31427	ER20		34	£9.50



ER Castleated Collet Nuts

Part Number	Collet	Nut Type	Nut Diameter (mm)	Price
OM31419	ER16	Castleated Collet Nut (GST)	32	£9.50
OM31420	ER20		35	£9.50
OM31421	ER25		42	£9.50
OM31422	ER32		50	£9.50
OM31423	ER40		63	£13.00
OM31424	ER50		78	£21.00



ER32 Short Nut

- Collet Nut for BT40/DV40 Short Collet Chuck

Part Number	Collet	Nut Type	Nut Diameter (mm)	Price
OM31445	ER32	Short Nut	36	£16.00



OZ Nuts

- Collet Nuts for OZ collet Chucks

Part Number	Collet	Nut Type	Nut Diameter (mm)	Price
OM30491	OZ 25	Standard OZ Nut	60	£16.00
OM31968	OZ 32		72	£16.00



GSK Collet Nuts

- High Speed Balanced Bearing Nut

Part Number	Collet	Nut Type	Nut Diameter (mm)	Price
OM30614	GSK 06	GSK High Speed Balanced Nut	19.5	£18.00
OM30615	GSK 10		27	£18.00
OM30616	GSK 16		40	£20.00
OM30617	GSK 25		55	£23.00



ER25A Pin Nut

- Nut For Floating Reamer Holder

Part Number	Description	Nut Diameter (mm)	Price
OM32509	UM ER25 Pin Type Nut	23.6	£13.00



Hydraulic Chuck Spares



Part Number	Description	Price
OM32184	Hex Key HC 5mm	£6.50
OM32247	Hydraulic Sleeve Extractor	£12.80

Mini Spanners



- Spanners for Mini ER Collet Nuts

Part Number	Collet Size	Spanner Type	Price
OM31400	ER8	Mini Spanner (CMT)	£9.50
OM31401	ER11		£9.50
OM31402	ER16		£9.50
OM31403	ER20		£9.50
OM31404	ER25		£9.50

ER32 Short Spanner



- Spanner for BT40/DV40 ER32 SHORT Collet Chuck

Part Number	Collet Size	Spanner Type	Price
OM31446	ER32	Spanner for BT40/DV40 ER32 Short	£20.00

OZ Spanners



- Spanners for OZ Collet Nuts

Part Number	Size	Spanner Type	Price
OM30492	OZ 25	Hook Spanner	£11.00
OM30493	OZ 32		£13.00

HSK Coolant Tubes



Part Number	Description	Price
OM30173	HSK63A Coolant Tube	£9.50
OM30174	HSK100A Coolant Tube	£10.50

Hexagon Spanners



- Spanners for Hexagon ER Collet Nuts

Part Number	Collet Size	Spanner Type	Price
OM31411	ER11	Hexagon Spanner (CSX)	£9.50
OM31412	ER16		£9.50
OM31413	ER20		£9.50

Power Chuck Spanners



- Spanners for Power Milling Chucks

Part Number	Size	Spanner Type	Price
OM33028	SC 20 / 25mm	Spanner for Power Milling Chucks	£11.00
OM33029	SC 32mm		£11.00
OM31166	UPMC 20mm	Spanner for UPMC Power Milling Chucks	£15.00
OM31168	UPMC 32mm		£15.00

Drill Chuck Hex Key



- Hexagon Key for Premium Drill Chucks

Part Number	Drill Chuck Size	Description	Price
OM33680	1-13mm, 1-16mm	6mm x 130L Hex Key	£14.00

HSK Coolant Tube Spanners



Part Number	Description	Price
OM32523	HSK63A Coolant Tube Spanner	£13.00
OM32539	HSK100A Coolant Tube Spanner	£16.00

Castellated Spanners



- Spanners for Castellated ER Collet Nuts

Part Number	Collet Size	Spanner Type	Price
OM31405	ER16	Castellated Spanner (CST)	£9.50
OM31406	ER20		£9.50
OM31407	ER25		£9.50
OM31408	ER32		£9.50
OM31409	ER40		£12.00
OM31410	ER50		£19.00

Drill Chuck Spanners



- Spanners for Keyless Drill Chucks

Part Number	Drill Chuck Size	Spanner Type	Price
OM31428	1-13mm	APU 13 Spanner	£10.50
OM31429	1-16mm	APU 16 Spanner	£10.50
OM33499	1-13mm	NCDC 13 Spanner	£13.00

ER25A Pin Spanner



- Spanner For Floating Reamer Holder

Part Number	Description	Price
OM32510	ER25A Pin Type Spanner	£13.00

HSK Sealing Plugs



Part Number	Description	Price
OM32540	HSK63A Plug M18 x 1	£4.50
OM32541	HSK100A Plug M24 x 1.5	£4.50

GSK Spanners



- Bearing Spanners for GSK Collet Chucks

Part Number	Collet Size	Spanner Type	Price
OM30610	GSK 06	GSK Bearing Spanner	£22.00
OM30611	GSK 10		£22.00
OM30612	GSK 16		£26.00
OM30613	GSK 25		£29.00

Combi Shell Mill Spanners



- Cross Wrenches for Combination Shell Mill Arbors

Part Number	Size (mm)	Spanner Type	Price
OM31440	16	Cross Wrench for Combi Face Mill Arbors	£14.00
OM31441	22		£16.00
OM31442	27		£16.00
OM31443	32		£17.00
OM31444	40		£19.00

Hex Keys for DMC Chucks



Part Number	Description	Price
OM31543	4x200 Hex Key	£8.50
OM31544	5x200 Hex Key	£9.50
OM31545	6x200 Hex Key	£9.50

Spindle Wipers

Part Number	Taper	Price
OM19227	BT/DV 30	£9.00
OM19229	BT/DV 40	£11.00
OM19231	BT/DV 50	£16.00
OM31962	HSK 63	£26.00



Clutch Drive Rings for Combi Shell Mill Holders

Part Number	Pilot Diameter (mm)	List Price
OM16313	16	£11.00
OM16315	22	£14.00
OM16317	27	£14.00
OM16319	32	£17.00
OM16321	40	£20.00



Clamping Screws for End Mill Holders

Part Number	Sidelock Diameter (mm)	M	Price
OM31452	6	M6	£6.50
OM31453	8	M8	£6.50
OM31454	10	M10	£6.50
OM31455	12	M12	£6.50
OM31456	16 & 18	M14	£6.50
OM31457	20	M16	£6.50
OM31456	20 x 35mm Gauge Length	M14	£6.50
OM31458	25	M18 x 2	£6.50
OM31456	25 x 35mm Gauge Length	M14	£6.50
OM31454	25 x 70mm Gauge Length	M10	£6.50
OM31459	32	M20 x 2 x 20	£6.50
OM31454	32 x 65mm Gauge Length	M10	£6.50
OM31460	40	M20 x 2 x 25	£6.50



Back Stop Screws for ER Collet Chucks

Part Number	ER Chuck	M	Price
OM31955	ER11	M6	£6.50
OM31956	ER11	M8	£6.50
OM31957	ER16	M11x1	£6.50
OM31958	ER20	M14x1	£6.50
OM31959	ER25	M18x1.5	£6.50
OM31960	ER32	M22x1.5	£6.50
OM31961	ER40	M28x1.5	£6.50



Precision Modular Vices

- Hardened & Precision Ground
- Surface Hardness HRC60 +2
- Suitable for various machining centres

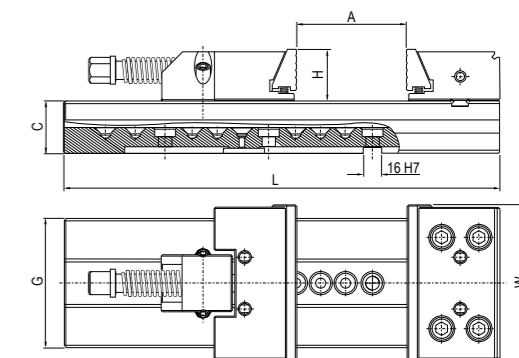

Part Number	Dimensions (mm)						Clamping Force (KG)	Price
	W	A	L	H	C	G		
OM20310	100	100	270	30	35	75	3000	£365.00
OM20311	125	150	345	40	40	95	3000	£445.00
OM20312	150	200	420	50	50	125	5000	£545.00
OM20313	150	300	520	50	50	125	5000	£625.00
OM20314	175	300	555	60	58	145	6000	£805.00
OM20315	175	400	655	60	58	145	6000	£885.00
OM20319	200	300	595	65	70	170	10000	£1,045.00
OM20320	200	400	695	65	70	170	10000	£1,165.00

Spare Jaws for Modular Vices

Part Number	Jaw Type	Width (mm)	Price
OM20302	Plain	100	£42.00
OM20303	Grooved	100	£42.00
OM20304	Plain	125	£45.00
OM20305	Grooved	125	£45.00
OM30189	Plain	150	£50.00
OM30190	Grooved	150	£50.00
OM20306	Plain	175	£59.00
OM20307	Grooved	175	£59.00
OM20308	Plain	200	£98.00
OM20309	Grooved	200	£98.00



OM20330	Plain Soft Jaws	100	£49.00
OM20331	Plain Soft Jaws	125	£54.00
OM20332	Plain Soft Jaws	150	£65.00
OM20333	Plain Soft Jaws	175	£79.00
OM20334	Plain Soft Jaws	200	£98.00

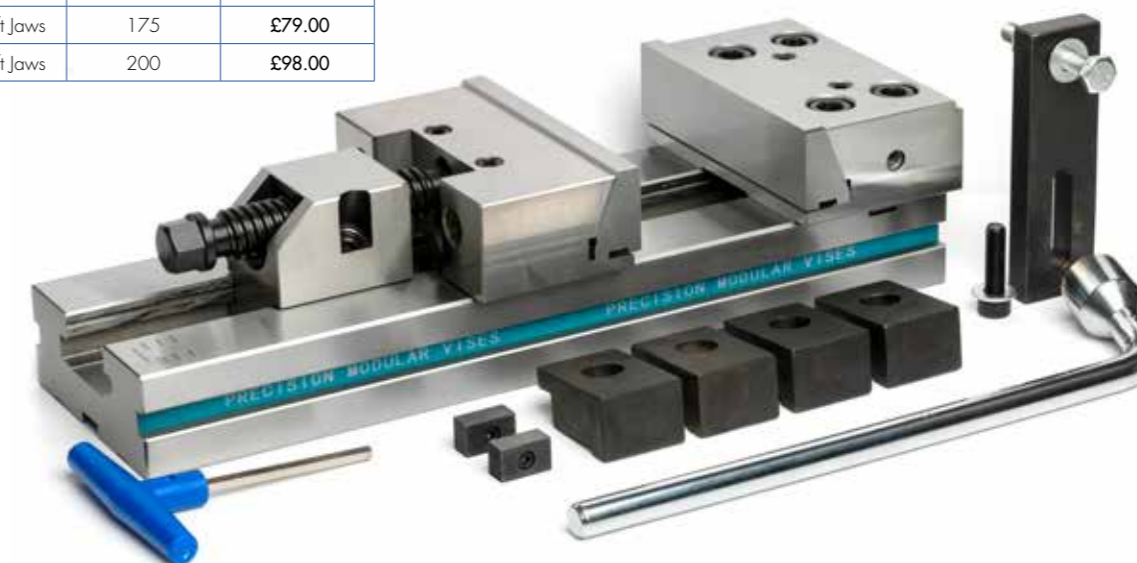

HEAVY DUTY, HIGH SPEED 'TYPE R' MODEL REVOLVING CENTRES

- Capable of running at high speeds with heavy loads on CNC machine applications
- Sealed for life using high quality German seals, bearings and Kluber grease
- Hardened and precision ground

STANDARD POINT

Part Number	Morse Taper	Head Dia (mm)	Point Length x Dia (mm)	Max RPM	Max Load (kg)	Concentricity (mm)	Price
OM15701	MT 3	62	34 x 28	4500	375	0.008	£84.00
OM15702	MT 4	68	41 x 32	3450	600	0.008	£94.00
OM15703	MT 5	87	51 x 38	2700	1500	0.008	£134.00
OM15704	MT 6	102	57.5 x 50	2300	2600	0.015	£545.00

EXTENDED POINT

Part Number	Morse Taper	Head Dia (mm)	Point Length x Dia (mm)	Max RPM	Max Load (kg)	Concentricity (mm)	Price
OM15705	MT 3	62	51 x 28	4500	300	0.008	£84.00
OM15706	MT 4	68	54.5 x 32	3450	375	0.008	£94.00
OM15707	MT 5	87	65 x 38	2700	900	0.008	£134.00
OM15708	MT6	102	81 x 50	2300	2600	0.015	£545.00



MEDIUM DUTY, SMALL CASING MODEL REVOLVING CENTRES

- Excellent problem solver for applications requiring maximum component access
- Capable of running at very high speeds with medium load application
- Sealed for life using high quality German seals, bearings and Kluber grease
- Hardened and precision ground

STANDARD POINT

Part Number	Morse Taper	Head Dia (mm)	Point Length x Dia (mm)	Max RPM	Max Load (kg)	Concentricity (mm)	Price
OM15709	MT 2	34	19 x 15	6300	150	0.008	£62.00
OM15710	MT 3	34	19 x 15	6300	375	0.008	£71.00
OM15711	MT 4	42	25 x 20	5600	600	0.008	£79.00
OM15712	MT 5	68	41 x 32	3300	1500	0.015	£129.00

EXTENDED POINT

Part Number	Morse Taper	Head Dia (mm)	Point Length x Dia (mm)	Max RPM	Max Load (kg)	Concentricity (mm)	Price
OM15713	MT 2	34	29 x 15	6300	125	0.008	£62.00
OM15714	MT 3	34	30 x 15	6300	250	0.008	£71.00
OM15715	MT 4	42	38 x 20	5600	375	0.008	£79.00
OM15716	MT 5	68	53 x 32	3300	900	0.015	£129.00



STANDARD COMPACT MODEL

- Suitable for medium & light duty applications on conventional machines at slower speeds
- Bearings are sealed to prevent ingress of coolant & swarf

STANDARD POINT

Part Number	Morse Taper	Head Dia (mm)	Point Length x Dia (mm)	Max RPM	Max Load (kg)	Concentricity (mm)	Price
OM15717	MT 1	46.5	26 x 18	4000	25	0.015	£30.00
OM15718	MT 2	50	31 x 23	3000	50	0.015	£34.00
OM15719	MT 3	62	38 x 30	2500	75	0.015	£36.00
OM15720	MT 4	62	38 x 30	2200	100	0.015	£42.00
OM15721	MT 5	68	42 x 34	1500	150	0.015	£58.00



STANDARD DEAD CENTRES

- 60°
- Hardened & Precision Ground

Part Number	Size (MT)	Description	Price
OM15722	MTA 1	DG1 60 degree Hardened / Ground	£6.00
OM15723	MTA 2	DG2 60 degree Hardened / Ground	£7.00
OM15724	MTA 3	DG3 60 degree Hardened / Ground	£8.00
OM15725	MTA 4	DG4 60 degree Hardened / Ground	£11.00
OM15726	MTA 5	DG5 60 degree Hardened / Ground	£22.00



CARBIDE TIP DEAD CENTRES

- 60°
- Hardened & Precision Ground

Part Number	Size (MT)	Description	Price
OM15732	MTA 1	DE1 60 degree Carbide Tipped	£13.00
OM15733	MTA 2	DE2 60 degree Carbide Tipped	£15.00
OM15734	MTA 3	DE3 60 degree Carbide Tipped	£21.00
OM15735	MTA 4	DE4 60 degree Carbide Tipped	£30.00
OM15736	MTA 5	DE5 60 degree Carbide Tipped	£42.00



HALF NOTCHED DEAD CENTRES

- 60°
- Hardened & Precision Ground

Part Number	Size (MT)	Description	Price
OM15727	MTA 1	DH1 60 degree Hardened / Ground	£7.00
OM15728	MTA 2	DH2 60 degree Hardened / Ground	£8.00
OM15729	MTA 3	DH3 60 degree Hardened / Ground	£11.00
OM15730	MTA 4	DH4 60 degree Hardened / Ground	£16.00
OM15731	MTA 5	DH5 60 degree Hardened / Ground	£24.00



CARBIDE TIP HALF NOTCH DEAD CENTRE

- 60°
- Hardened & Precision Ground

Part Number	Size (MT)	Description	Price
OM15737	MTA 1	DH1 60 degree Carbide Tipped	£15.00
OM15738	MTA 2	DH2 60 degree Carbide Tipped	£17.00
OM15739	MTA 3	DH3 60 degree Carbide Tipped	£23.00
OM15740	MTA 4	DH4 60 degree Carbide Tipped	£32.00
OM15741	MTA 5	DH5 60 degree Carbide Tipped	£50.00





Omega Products
45 Cobham Road
Ferndown Industrial Estate
Wimborne
BH21 7QZ

T. 01202 745179
E. sales@omegaproducts.co.uk
W. www.omegaproducts.co.uk

VERSION 01. 2022